

User Manual

Version V1.5-20240905



BX50L-TAP GNSS RTK&PPP Board User Manual

©2024 Tersus GNSS Inc. All rights reserved.



Sales Enquiry: sales@tersus-gnss.com

Technical Support: support@tersus-gnss.com

More details, please visit www.tersus-gnss.com

Revision History

Rev	Description	Date
1.0	Initial release	20240326
1.1	Update TAP	20240513
1.2	Update Section3.1	20240607
1.3	Update Section3.1	20240701
1.4	Update Section1.2&3.2	20240806
1.5	Update Section1.3.2&4	20240905

BX50L-TAP User Agreement

Copyright © 2024 Tersus GNSS Inc.

CAUTION! Please read this notice carefully before using BX50L-TAP. Use of BX50L-TAP indicates acceptance of the terms and conditions of the User Agreement.

Thank you for using BX50L-TAP! This agreement is a legally binding contract between Tersus GNSS Inc. and you regarding the user of BX50L-TAP. Please read all the terms and conditions listed in the agreement carefully. Use of BX50L-TAP indicates that you have agreed to accept all of the terms of this Agreement. If you have any questions about the content of the terms of this Agreement, please contact Tersus GNSS Inc. If you do not agree to any of the terms and conditions of this Agreement, please do not proceed with the subsequent operations.

1. License

Tersus provides users with free licenses for Tersus software and related materials, for the purpose of product needs and improvement, when users use Tersus products. Tersus does not guarantee that the free license will not be changed. The license fee will be calculated according to the price published on Tersus official website <http://www.tersus-gnss.com>. Before you pay the license fee as agreed, Tersus will reserve the right not to provide you with Tersus software and related materials. Without the permission of Tersus, users are not allowed to resell it to a third party or use Tersus software and related materials to obtain income through other means in any way.

2. Proprietary Rights

The user agrees that Tersus software and related materials shall belong to Tersus, and Tersus retains exclusive ownership of the trademarks and service

marks represented by its company name and logo and all of the documentation related. The user agrees that all technologies, algorithms and processes contained in Tersus software constitute commercial secrets, and the user will protect them. User may not reverse engineer, decompile or disassemble the software, nor alter images used in the software and the documentation. The user are not allowed to copy, modify, and reproduce relevant information, no matter it is modified or translated into another language, unless the permission of Tersus is obtained. The user agrees that if the user violates this agreement, he will be liable for damages determined by the court.

3.Customer Service

According to the situation of users using BX50L-TAP, Tersus will continue to add features, improve performance and experience. Although it is the Tersus's customary practice to provide reasonable assistance and support in the use of Tersus products to customers, Tersus shall not be obligated to any user to provide technical assistance or support through this agreement, and may at Tersus's sole election charge a fee for customer service.

4.Update Policy

Tersus may regularly or irregularly, update the firmware of BX50L-TAP to add functions or fix issues. Tersus is not obliged to provide updates or modifications to any user, nor do we guarantee that that updates or modifications are fully in line with expectations.

5.Disclaimer

Tersus will try best to make that the function of BX50L-TAP run normally and the data calculation is correct, but Tersus does not guarantee that all functions of the BX50L-TAP meets the expectations, the data calculation is correct and the stability of the BX50L-TAP runs stably. Tersus and distributors will not be

liable for any indirect, special, incidental, consequential or exemplary damages caused in any way.

6.Termination

This agreement is hereby terminated by mutual agreement or by any breach of any one or more provisions of this agreement by either party. In such cases, all rights of Tersus shall remain in force and effect. Any protected information data of user maintained on database shall upon notice to the user and at the discretion of Tersus may be destroyed.

7.Copyright

Tersus BX50L-TAP and related materials (including, but not limited to, any images, photographs, animations, video, audio, music or text incorporated into the BX50L-TAP), and all intellectual property rights associated with it, whether exists in a tangible media or in an electronic media is owned by Tersus. You may not remove or alter any trademark, logo, copyright and other proprietary notice in or on the products.

8.Other

Tersus has the right to amend all the contents of this agreement and product policy, and the right to interpret them within the scope of law.

This agreement will be effective once it is published, and Tersus has the right to modify the content of the agreement at any time, and the modified results will be published on the Tersus website. If you do not agree with the modifications made, you have the right to stop using BX50L-TAP. If the user continues to use, it is deemed that the user accepts the modifications.

The conclusion, implementation and interpretation of this agreement and the settlement of disputes shall be governed by the laws of China and subject to the jurisdiction of the Chinese courts. If any dispute arises between the parties regarding the content of this agreement or its implementation, the parties shall

try to resolve it through friendly consultation; if consultation fails, either party may file a lawsuit in the court where Tersus GNSS is located.

Table of Content

Revision History	I
BX50L-TAP User Agreement	II
Table of Content	VI
List of Figures	VIII
List of Tables	VIII
Notices	1
1. Introduction	2
1.1 Overview of BX50L-TAP GNSS Board	2
1.2 Board Features	3
1.3 Related Information	4
1.4 BX50L-TAP System Overview	5
1.4.1 BX50L-TAP Board	6
1.4.2 Antenna	7
1.4.3 Power Supply	7
1.4.4 Communication Equipment	7
1.4.5 Internal eMMC	8
2. Installation	8
2.1 Unpacking	8
2.2 Environmental Conditions	8
2.3 Selecting a GNSS antenna	9
2.4 Board Installation	10
2.5 Tersus GNSS Center Software	11

3. Technical Specifications	13
3.1 BX50L-TAP Specifications	13
3.2 System Integration	17
3.2.1 Connectors on BX50L-TAP Board	17
4. Typical Application	19
4.1 Firmware Upgrade	19
4.2 Auth Code	23
4.3 PPP Configuration	25
4.4 PPP&RTK Switching	26
4.5 RTK Configuration	26
4.6 Data Collection on Internal eMMC	28
4.7 Download Files from Internal eMMC	29
4.8 Communicate with STRSVR Tool	30
5. Terminology	32

List of Figures

Figure 1.1	System Overview of BX Boards	5
Figure 2.1	Config Page of Tersus GNSS Center	11
Figure 2.2	Main Windows of Tersus GNSS Center	12
Figure 3.1	The 24-pin connector	17
Figure 4.1	Main interface of Tersus GNSS Center	20
Figure 4.2	Stop button on Tersus GNSS Center	20
Figure 4.3	Find UpdateFirmware in Tools bar	20
Figure 4.4	Select file to update	21
Figure 4.5	Update in progress	21
Figure 4.6	Firmware update successful	22
Figure 4.7	Advance setting for firmware update	22
Figure 4.8	Advance Update Setting	23

List of Tables

Table 1.1	Document / Software used in this User Manual	4
Table 2.1	Definition of the lights on Tersus GNSS Center	12
Table 3.1	BX50L-TAP Board Specifications	13
Table 3.2	24-pin header signals definition	17
Table 3.3	6-pin header signal definition	18

Notices

The following notices apply to Tersus BX50L-TAP board.

	Changes or modifications to this equipment not expressly approved by Tersus could void the user's authority to operate this equipment or even has risk to damage the GNSS RTK Boards.
---	---

Conventions

The following conventions are used in this manual:

	Information that supplements or clarifies text.
---	---

	A caution that actions, operation or configuration may lead to incorrect or improper use of the hardware.
---	---

	A warning that actions, operation or configuration may result in regulatory noncompliance, safety issues or equipment damage.
---	---

In this manual, all the commands are in capital letters, which is just for easy identification, the commands are not case-sensitive.

1. Introduction

1.1 Overview of BX50L-TAP GNSS Board

The BX50L-TAP adopts Tersus Antares chip, and provides real-time monitoring of interference signals and automatic filtering. It tracks all current GNSS constellations including GPS, GLONASS, Galileo, BeiDou, QZSS, SBAS, and IRNSS to improve continuity and reliability of RTK solutions that provide centimeter positioning.

The BX50L-TAP includes TAP, the satellite-based precise point positioning service developed by Tersus GNSS. With TAP, the GNSS rover board will not need to work with the local RTK base station or CORS, but directly receives corrections broadcast by the satellite, such as ephemeris error, satellite clock error, etc.

The BX50L-TAP board supports multiple constellations and multiple frequencies to improve the continuity and reliability of the RTK solution even in harsh environments. In-built 8GB memory makes data collection easy. It features compatibility with other GNSS boards in the market via flexible interfaces, smart hardware design, and commonly used log/command formats.

For further information about BX50L-TAP GNSS board, refer to

<https://www.tersus-gnss.com/> for more details.

1.2 Board Features

The BX50L-TAP board has the following features:

- Multiple constellations & frequencies
 - GPS L1 C/A, L1C, L2C, L2P, L5C
 - GLONASS L1OF, L2OF, L3OC
 - BeiDou B1I, B2I, B3I, B1C, B2a, B2b
 - Galileo E1, E5a, E5b, E5AltBOC, E6
 - QZSS L1 C/A, L1C, L2C, L5C
 - SBAS L1 C/A, L5
 - IRNSS L5
 - L-Band
- 1792 channels
- TAP
- Centimeter-level position accuracy
- Flexible interfaces such as RS232, TTL, USB, CAN, Ethernet
- PPS output and event mark input
- up to 20Hz RTK solution updates and raw data output
- In-built 8GB memory makes data collection easy
- Pin-to-pin compatible with Trimble BD970
- Log/command compatible with NovAtel protocol

1.3 Related Information

Table 1.1 Document / Software used in this User Manual

Name	Description	Link
Log & Command document	Document providing all the loggings output from BX50L-TAP boards and all the commands to the boards	BX50C GNSS OEM Board Tersus GNSS (tersus-gnss.com)
Tersus Tool Suite	Tersus Tools including TersusDownload, TersusGeoPix, TersusGNSSCenter, TersusUpdate, TersusRinexConverter	https://www.tersus-gnss.com/software
RTKLIB	A free & popularly used Post processing tool	http://www.rtklib.com/

Support

If there is any problem and the information needed cannot be found in the product documentation, request technical support by sending email to support@tersus-gnss.com or logging a ticket in our tracking system <https://tersus.supportsystem.com/> .

1.4 BX50L-TAP System Overview

To make BX50L-TAP board work, the following parts are necessary:

- ✧ Interface board and cables
- ✧ Power supply
- ✧ Data communications equipment
- ✧ GNSS antenna with Low Noise Amplifier (LNA)

The BX50L-TAP board is illustrated in the figure below.

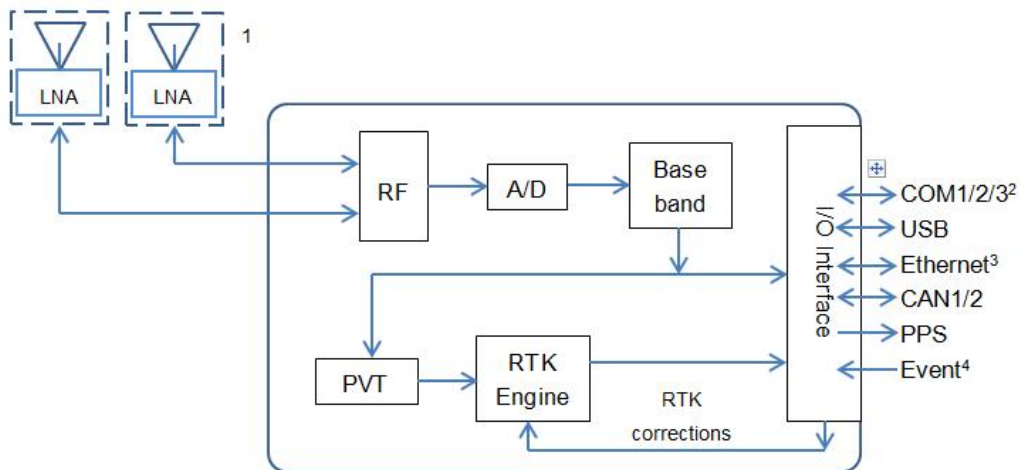

Figure 1.1 System Overview of BX Boards

Note 1. BX50L-TAP only support single antenna.

2. COM3_TX is multiplexed with CAN1_TX, COM3_RX is multiplexed with Event 2.

3. Hardware of Ethernet is ready, reserved for future upgrade.

4: Currently two event inputs are supported.

1.4.1 BX50L-TAP Board

The BX50L-TAP board is shown as below.



Figure 1.2 The BX50L-TAP Board

BX50L-TAP board consists of a Radio Frequency (RF) section and a digital section.

Radio Frequency (RF) Section

The board obtains filtered, amplified GNSS signals from the antenna. The RF section down converts the incoming RF signals to Intermediate Frequency (IF) signals which are processed by the digital section. The RF section also supplies power to the active antenna LNA through the coaxial cable. The RF section has been designed to reject common sources of interference.

Digital Section

The core of the digital section is the base band, which is realized with a FPGA chip. The digital section digitizes and processes the base band signals to obtain a PVT (Position, Velocity and Time) solution. If RTK corrections from the base are received, the board will output cm-level position. The digital section also processes the system I/O, shown in Figure 1.1.

1.4.2 Antenna

The antenna converts electromagnetic signals transmitted by GNSS satellites into electrical signals that can be used by the board.

An active GNSS antenna is required for optimal board performance. Tersus is providing active GNSS antennas with precise phase centers and robust enclosures (refer to [GNSS Antennas | Tersus GNSS \(tersus-gnss.com\)](https://tersus-gnss.com) for more information about antennas.

Tersus antennas and coaxial cables meet board RF input gain requirements. Tersus coaxial cables are designed to introduce no more than 10dB loss and Tersus antennas are required with built-in LNAs that provide 33~40dB of gain to the satellite signal received.

1.4.3 Power Supply

A power supply capable of delivering the minimum board operating voltage and power is required. The board operates at +3.3 VDC $\pm 5\%$, if the voltage supplied is below the specification, the board suspends operation.



The BX50L-TAP board supports reversed polarity protection.

1.4.4 Communication Equipment

A computer, a tablet or other data communications device are necessary to communicate with the board, and to receive and store the data that the board outputs.

1.4.5 Internal eMMC

BX50L-TAP board supports up to 8GB internal eMMC. According to the default configuration of the board 1Hz output calculation, 24h hookup can store 5 days of logs. After the storage is full, it will automatically clear the earliest logs according to date.

2. Installation



The BX50L-TAP board can be integrated to the customer's system in various packages, and all actions can refer to the installation guide in this chapter.

2.1 Unpacking

Inspect the shipping cartons visually for any signs of damage or mishandling before unpacking the board. Immediately report any damage to the shipping carrier. Please check each item according to your order and the item list to confirm that all the accessories are correct for the purchased order.

2.2 Environmental Conditions

Install the board in a location situated in a dry environment with ESD protection.

Avoid exposure to extreme environment conditions including:

- Water or excessive moisture
- Excessive heat greater than 85 °C (185 °F)

- Excessive cold less than $-40\text{ }^{\circ}\text{C}$ ($-40\text{ }^{\circ}\text{F}$)
- Corrosive fluids and gases

Avoiding these conditions improves the board's performance and long-term reliability.

2.3 Selecting a GNSS antenna

The BX50L-TAP tracks multiple GNSS frequencies, ensure that the antenna you choose supports the frequencies you need to track.

The antennas provided by Tersus can be found on Tersus website [GNSS Antennas | Tersus GNSS \(tersus-gnss.com\)](https://www.TERSUS-GNSS.com). It is highly recommended that the antennas from Tersus are used to work with BX50L-TAP.

If a non-Tersus GNSS antenna is chosen, a typical antenna LNA gain between 32dB and 40dB is recommended in a rover station application.

The power to the antenna LNA is provided through the board's RF port center conductor. BX50L-TAP provides +5.0 VDC $\pm 5\%$ at a maximum of 100mA.

!	For passive antennas, a spacer needs to be installed between the board and the antenna to prevent the antenna power supply from shorting out.
	Contact Tersus support if problem occurs when an antenna from other vendors is used.

When installing the antenna:

- Choose an antenna location with a good view of the sky so that there is no obstruction from horizon to horizon.
- Mount the antenna on a secure, stable structure capable of safe operation in the specific environment.

- Avoid areas with high vibration, excessive heat, electrical interference, and strong magnetic fields.
- Avoid mounting the antenna close to stays, electrical cables, metal masts, and other antennas.
- Avoid mounting the antenna near transmitting antennas, radar arrays, or satellite communication equipment.

2.4 Board Installation

When the appropriate equipment is selected, complete the following steps to set up and begin using the BX50L-TAP.

- a) Install the BX50L-TAP board in an enclosure or on a mother board.
- b) Mount the GNSS antenna to a secure, stable structure.
- c) Connect the GNSS antenna to the board with a GNSS antenna cable.
- d) Apply power to the board, as described in section 1.4.3.
- e) Connect the board to a computer or other data communications equipment.



When BX50L-TAP board is handled, follow the guides below to avoid damage from ESD.

- Always wear a properly grounded anti-static wrist strap when handling BX50L-TAP board.
- Always hold the board by the corners or the RF shield: avoid direct contact with any of the components.
- Never let the board come in contact with clothing. The ground strap cannot dissipate static charges from fabrics.

- Failure to follow accepted ESD handling practices could cause damage to the board permanently.
- The warranty may be void if equipment is damaged by ESD.

2.5 Tersus GNSS Center Software

BX50L-TAP GNSS RTK board has serial ports, hence lots of serial tools can be used to communicate with the board. Tersus GNSS Center is a windows-platform-based serial tool, which is recommended to communicate with the BX50L-TAP board. Tersus GNSS Center can be downloaded from Tersus website <https://tersus-gnss.com/software> .

Connect BX50L-TAP to a laptop/PC with an external cable. Run Tersus GNSS Center, the following config page is shown, input the port and band rate (default is 115200).

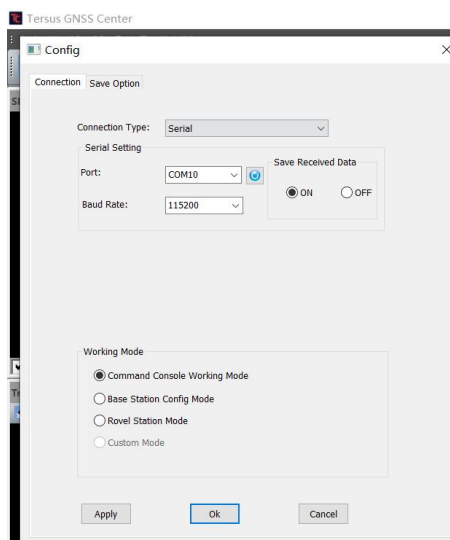

Figure 2.1 Config Page of Tersus GNSS Center

The following table gives definition for the five lights at the bottom of Tersus GNSS Center interface.

Table 2.1 Definition of the lights on Tersus GNSS Center

Lights	Description
Comm	GREEN: the communication with the board is established.
	RED: the communication with the board is not established.
TAP	GRAY: NOT support TAP.
	GREEN: support TAP.

Commands can be input in the text console window, an [OK] response is output after a command is input, or the command is not input successfully.

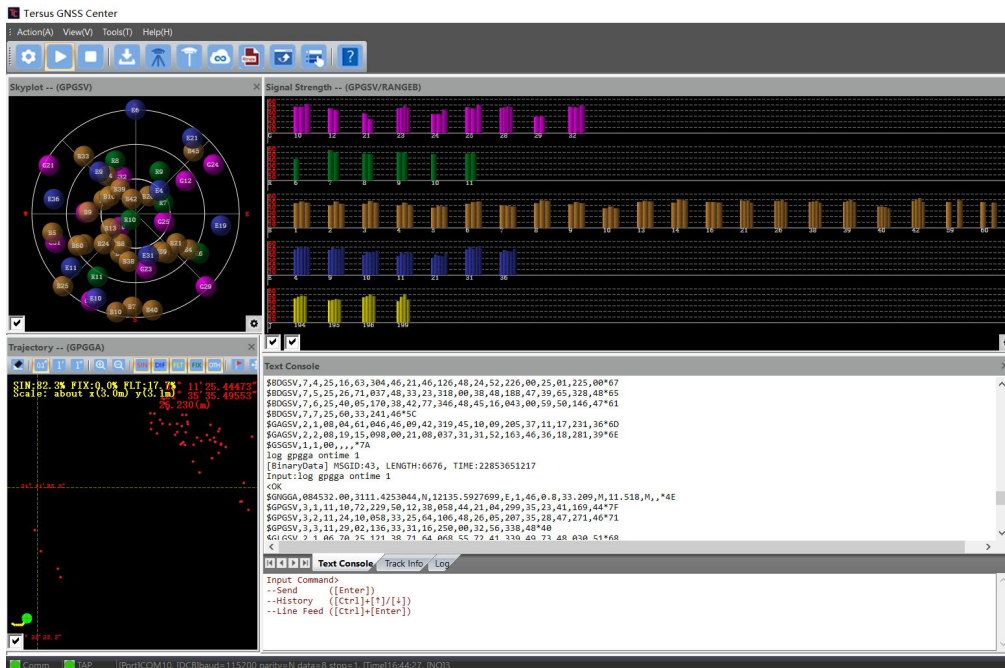

Figure 2.2 Main Windows of Tersus GNSS Center

! To active the skyplot, signal strength, trajectory and other windows, the antenna signals must be received and the following three loggings must be input to the board:

LOG GPGGA ONTIME 1	// output position and time
LOG GPGSV ONTIME 1	// output SVs in view, elevation and SNR (Signal Noise Ratio)
LOG RNAGEB ONTIME 1	// output PSR (Pseudorange) and ADR (Accumulated Doppler Range.)

refer to *Log & Command Reference document* for details.

3. Technical Specifications

3.1 BX50L-TAP Specifications

Table 3.1 BX50L-TAP Board Specifications

Performance		
Signal Tracking	GPS L1 C/A, L1C, L2C, L2P, L5C GLONASS L1OF, L2OF, L3OC BeiDou B1I, B2I, B3I, B1C, B2a, B2b Galileo E1, E5a, E5b, E5AltBOC, E6 QZSS L1 C/A, L1C, L2C, L5C SBAS L1 C/A, L5 IRNSS L5 L-Band	
GNSS Channels	1792	
Position Accuracy(RMS)	Single point positioning	1.5m (Horizontal)
		3.0m (Vertical)

	RTK positioning	8mm+1ppm (Horizontal)
		15mm+1ppm (Vertical)
	DGPS positioning	0.25m (Horizontal)
		0.5m (Vertical)
	High-Precision Static	2.5mm+0.1ppm (Horizontal)
		3.5mm+0.4ppm (Vertical)
TAP	Positioning Accuracy(RMS)	15mm (Horizontal)
		30mm (Vertical)
	Convergence Time	3 minutes
	Coverage	Global
	Signal stability	99.99%
Observation Accuracy (zenith direction):	C/A Code	10cm
	P Code	10cm
	Carrier Phase	1mm
Time to First Fix	Cold Start	<35s
	Warm Start	<10s
Reacquisition	<1s	
Time Accuracy(RMS)	20ns	
Velocity Accuracy(RMS)	0.03m/s	
Initialization (typical)	4s	
Initialization Reliability	>99.99%	
Correction	RTCM 2.3/3.0/3.1/3.2/CMR/CMR+	
Data output	NMEA-0183 and Tersus Binary Format	
Data Rate	20Hz	
Storage	In-built 8GB memory	
Communication		
Serial ports	RS-232 x1, TTL x2	

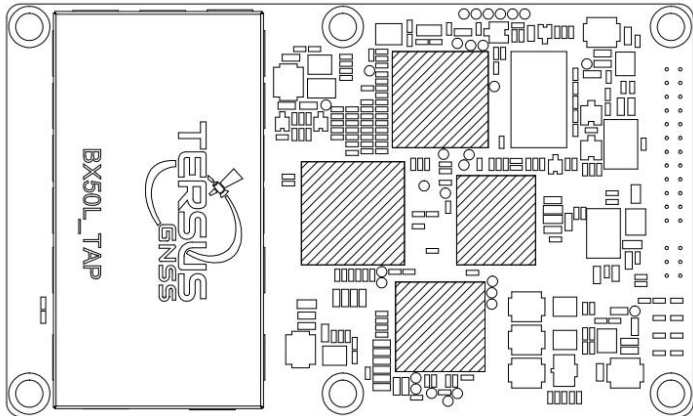
COM baud rate	Up to 921600bps
USB ports	USB 2.0 device x1
PPS ports	LVTTL x1
Event mark	LVTTL x1
Electrical	
Input Voltage	+3.3 VDC $\pm 5\%$
Power Consumption	1.9W (typical)
Physical	
Size	100 * 60 * 10.1 mm ³
Weight	44g
IO connectors	24pin header + 6pin header
Antenna Connector	MMCX female x1
Environmental	
Operating Temperature	-40°C ~ +85°C
Storage Temperature	-55°C ~ +95°C
Heat Sink Position	
	
<p>Note: For optimum heat transfer, Tersus recommends the use of thermal interface materials between the processor and the heat sink.</p>	
Mechanical Drawing	

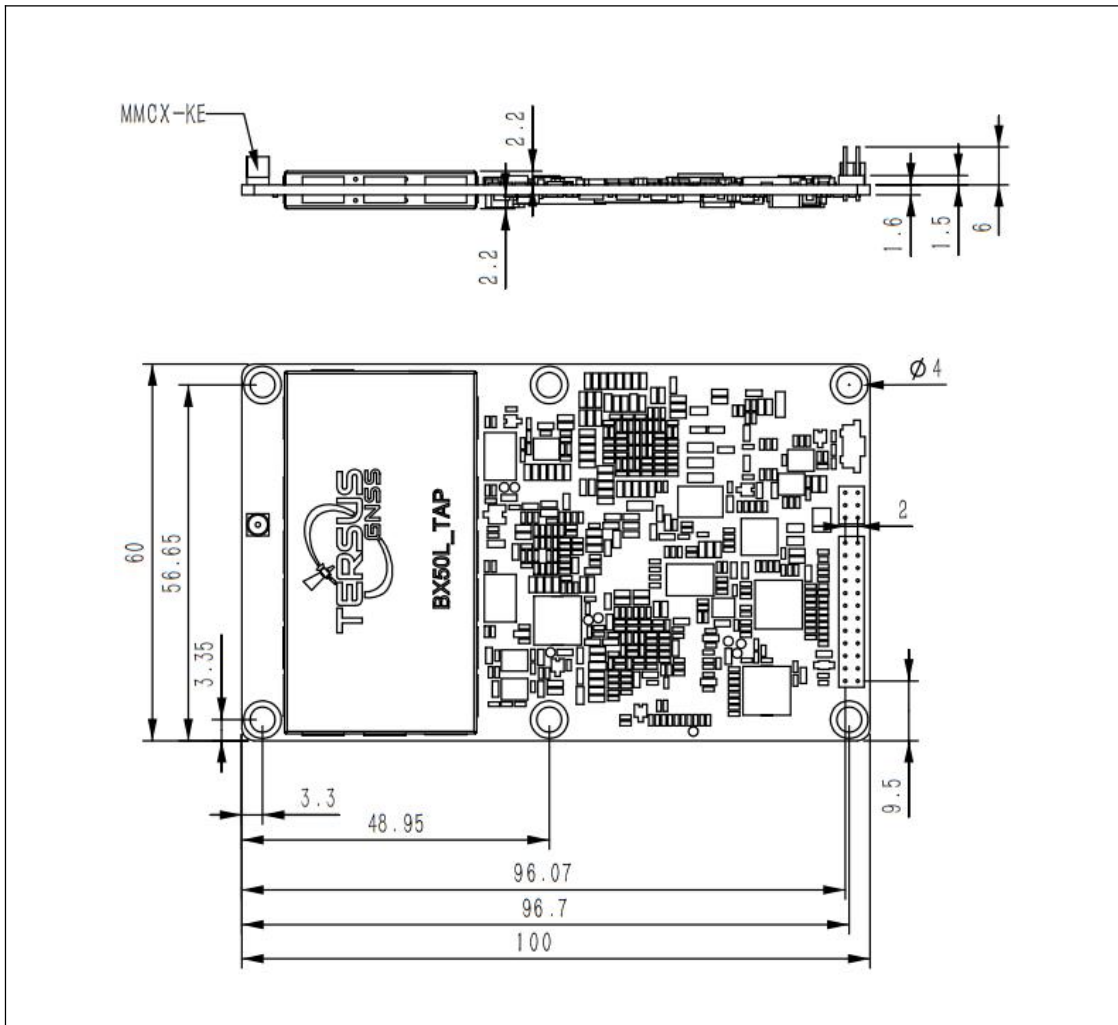

3.2 System Integration

3.2.1 Connectors on BX50L-TAP Board

There are two connectors on the BX50L-TAP board: a 24-pin and a 6-pin header. The 24-pin connector is shown below.

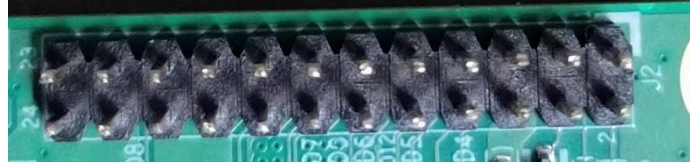

Figure 3.1 The 24-pin connector

Table 3.2 24-pin header signals definition

Pin	Signal	Type	Description
1	GND	GND	Ground digital ground
2	RTK_LED	O	RTK LED, flashes when an RTK correction is present.
3	RSV/POWER_OFF	IO	Reserved, compatible with power off
4	PPS	O	Pulse per second output, TTL level.
5	VCC	PWR	power supply
6	VCC	PWR	power supply
7	CAN1_RX/RX3/EVENT2	IO	CAN1_RX, CAN Receive line; COM3 RX, COM3 Receive line, TTL level; Event2, Event input, TTL level.
8	EVENT1	IO	Event1 input, TTL level
9	PWRLED	O	Power indicator, high when unit is on, low when off.
10	SATLED	O	Satellite LED, rapid flash indicates <5 satellites, slow flash indicates >5 satellites.
11	COM2_CTS	IO	COM2 Clear to Send, TTL level
12	nRESETIN	I	Reset input, active low to reset.
13	COM2_RTS	IO	COM2 Request to Send, TTL level
14	COM2_RX	I	COM2 Receive Data, TTL level
15	COM1_CTS	IO	COM1 Clear to Send, RS-232 level
16	COM2_TX	O	COM2 Transmit Data, TTL level
17	COM1_RTS	IO	COM1 Request to Send, RS-232 level
18	COM1_RX	I	COM1 Receive Data, RS-232 level
19	COM3_TX/CAN1_TX	O	COM3 Transmit Data, TTL level; CAN1 Transmit line.

20	COM1_TX	O	COM1 Transmit Data, RS-232 level
21	USB D-	IO	USB Data- bi-directional
22	USB D+	IO	USB Data+ bi-directional
23	GND	GND	Ground digital ground
24	GND	GND	Ground digital ground

Table 3.3 6-pin header signal definition

Pin	Signal	Type	Description
1	ETH_RD-	I	Ethernet board line minus. Differential pair.
2	ETH_RD+	I	Ethernet board line plus. Differential pair.
3	CENT_RD	IO	RD Magnetic center tap
4	ETH_TD+	O	Ethernet Transmit line plus. Differential pair.
5	ETH_TD-	O	Ethernet Transmit line minus. Differential pair.
6	CENT_TD	IO	TD Magnetic center tap.

*Hardware of Ethernet is ready, reserved for future upgrade.

4. Typical Application

4.1 Firmware Upgrade

If a new firmware update is released, it will be available on the Tersus web site <https://www.ter sus-gnss.com/software> , or you can get the updates from Tersus technical support by email support@tersus-gnss.com .

The firmware version of a Tersus receiver can be updated in field. Connect the COM2 port of the receiver with Tersus GNSS Center, and input 'LOG VERSION' in the text console, the following info will be output:

```
log version
>VERSION COM2 0 0.0 UNKNOWN 0 247.000 00000000 0 1
<
< 1
< GPSCARD BX50L 045001241000000256 0451001030000 1.0.1909_release Jul 16 2024 16:36:15
Input:log version
<OK
```

1909 is the firmware version. Refer to 'VERSION' in BX50L Log & Command Reference document for more details.

Please follow the steps below to upgrade the firmware.

- 1) Power on the BX50L-TAP GNSS board;
- 2) Run Tersus GNSS Center software and communicate with the receiver, refer to section 2.5 for details. Make sure the board has finished initialization, which can be confirmed by input 'LOG VERSION' in the console window and the board will output feedback;

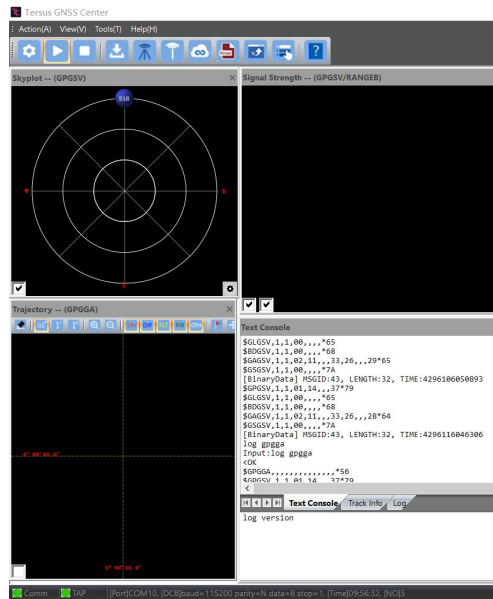

Figure 4.1 Main interface of Tersus GNSS Center

- 3) Click [Stop] button as shown below to terminate the communication between the computer and the receiver;

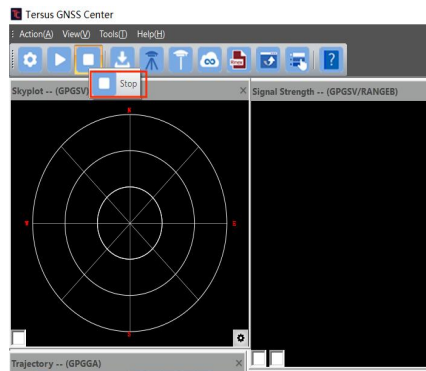

Figure 4.2 Stop button on Tersus GNSS Center

- 4) Select [Tools] -> [UpdateFirmware];

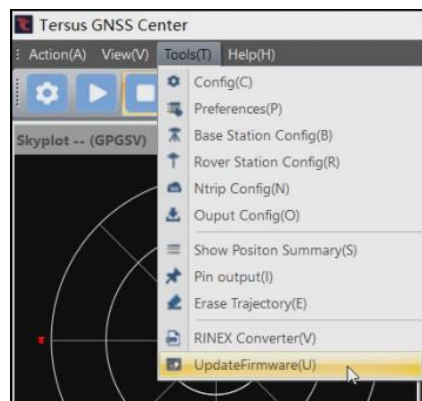

Figure 4.3 Find UpdateFirmware in Tools bar

- 5) Select the upgrade file. When a file is selected, the file is shown in the Update File bar. Select port and baud rate, click [Next];

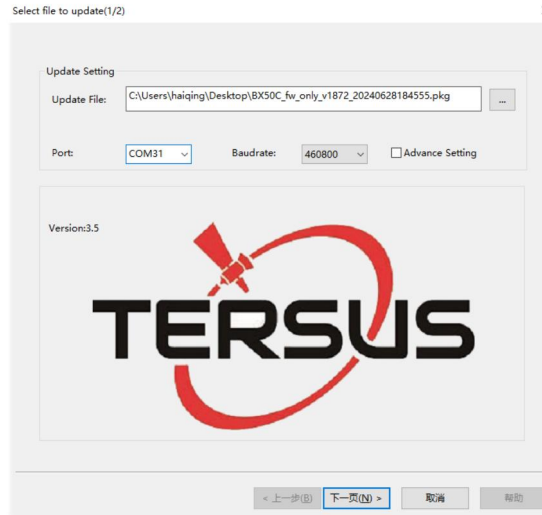

Figure 4.4 Select file to update

- 6) The following figure shows the firmware is upgrading, two progresses are included in the firmware update;

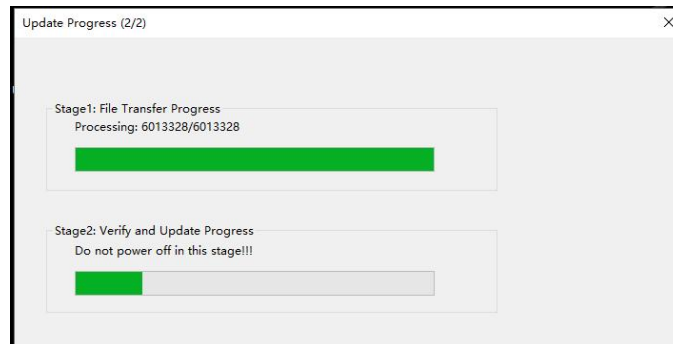

Figure 4.5 Update in progress



Do not power off the receiver during the verification and update process.

- 7) After the firmware is upgraded successfully, The following is shown;

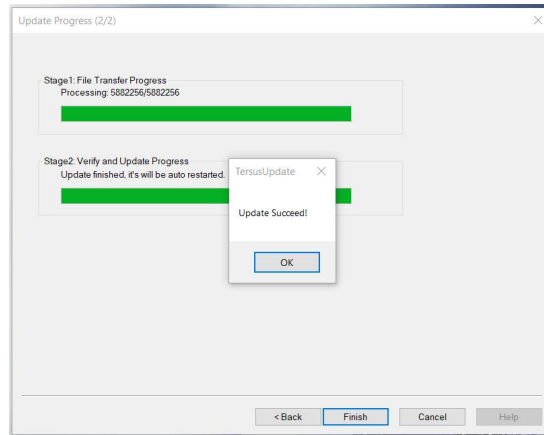

Figure 4.6 Firmware update successful

- 8) Click [OK] and [Finish] buttons to close the firmware upgrade windows, the receiver will reset automatically.
- 9) After the board is booted, the firmware version can be confirmed by repeating step 2.

Note:

There is Advance Setting option in the firmware update page, if a receiver

- **cannot boot up successfully, or**
- **cannot work well after boot up, or**
- **cannot finish FW update successfully according to the above steps,**

[Advance Setting] option can be selected to start FW update again.

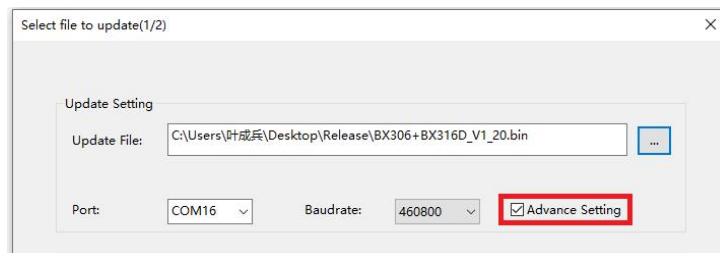

Figure 4.7 Advance setting for firmware update

If the [Advance Setting] is selected, the following page will be displayed, select [Manual Hardware Reset] and click [OK]. Click [Next] in the previous interface, power off the receiver, wait for five seconds and power on the receiver again.

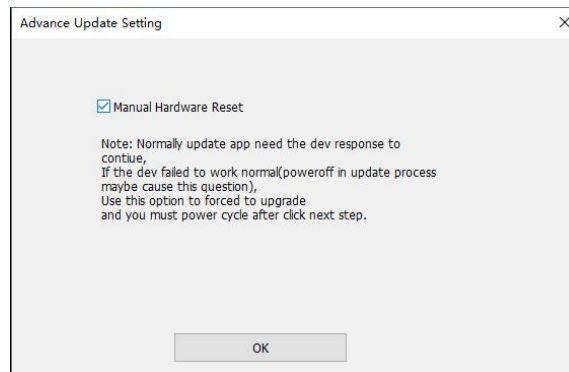

Figure 4.8 Advance Update Setting

After firmware update is finished, power off the receiver, wait for five seconds and power on the receiver again.



This option is for experienced users. If the customer is not sure whether it should be selected, contact Tersus technical support before select this option.

4.2Auth Code

An auth code is used to determine the features and valid time for a board. If the auth code is expired, the board will not work. And a license requirement is output from all the ports. Before contacting Tersus technical support for a new auth code, input:

LOG VERSION //query the SN and the current firmware version of the board

LOG AUTHLIST //query the board registration and PPP service expiration

In the text console window of Tersus GNSS Center when the receiver is connected with computer, and send all the output information to Tersus technical support.

Where in the AUTHLIST output message:

<status:valid level:4 expiredday:2099/12/31 group:0 groupnum:0

Displays the board registration expiration time;

<l-band:subscribed mode:PPP-AR expiredday:2023/08/21

Displays the PPP service registration expiration time.

If the PPP service registration code application is approved, Tersus technical support will assist in remote upgrade.

If the board registration auth code application is approved, you will get a txt file, in which command AUTHCODE and the auth code will be given, copy all of them (Ctrl + A & Ctrl + C) and paste them to the text console window of Tersus GNSS Center when the receiver is connected with computer.

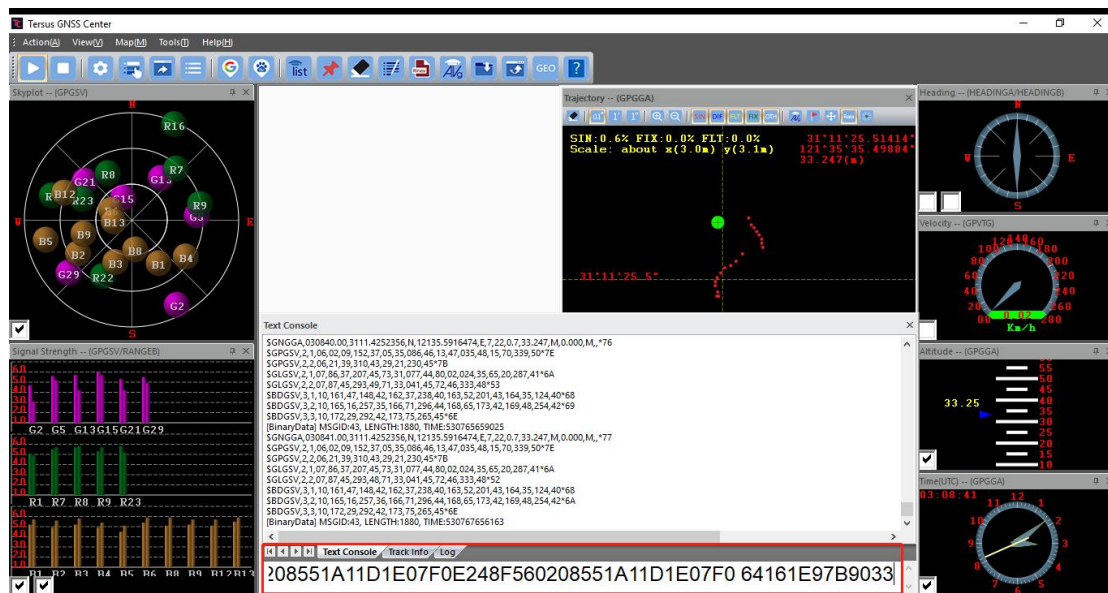

Figure 4.9 Register via Tersus GNSS Center

4.3 PPP Configuration

The PPP service is enabled by default, and the PPP registration code is within the validity to use the PPP service normally, please refer to the section 4.2 for details.

To check the current time, position and fix related data of the board, enter the command `[log gpgga ontime 1]`. The differential base station ID field in the output message represents the different results of the board, where ID=5000 represents that PPP has not yet converged, ID=5001 represents that PPP is converging, and ID=5002 represents that it has been PPP-AR fixed.

If the PPP is not fixed for a long time, enter the command `[log lbandtrackstat]` to query the L-Band signal tracking status of the board and analyze the Bit Error Rate (BER) in the output messages.

Under the environment of open sky, the BER is usually 0.000xxx; under the environment of obstruction, the BER is usually 0.00xxxx; under the environment of serious obstruction, the BER is usually 0.0xxxxx; the BER reaches 0.1xxxxx which is usually unfixed; the maximum BER is 0.300000, which means that the L-Band satellite is not tracked.

4.4 PPP&RTK Switching

To query whether the PPP service is enabled, enter the command [PPPSOURCE], the BX50L-TAP board enables the PPP service by default, so the default output is PPPSOURCE TapSat ENABLE Ntrip DISABLE.

Enter the command [PPPSOURCE TapSat DISABLE Ntrip DISABLE] to disable the PPP service. After the PPP service is disabled, the board can be positioned using RTK.

Enter the command [log gpgga ontime 1]. The differential base station ID field ID ≤ 4095 in the output message represents the RTK positioning result.

4.5 RTK Configuration

Example of RTK configuration (base mode):

```
UNLOGALL //remove all logs
UNDULATION USER 0.0 //Set user specified undulation value for ellipsoid height
FIX POSITION B L H //B: latitude (degree), L: longitude (degree), H: ellipsoid height (m)
// For example: FIX POSITION xx.xxxxxx xx.xxxxxxx xx.xx
or POSAVE ON 0.02 //Turn on position average for 0.02 hour (72s)
LOG COM2 RTCM1006 ONTIME 10 //output the base coordinate
LOG COM2 RTCM1074 ONTIME 1 //output GPS observations
LOG COM2 RTCM1084 ONTIME 1 //output GLONASS observations
LOG COM2 RTCM1094 ONTIME 1 //output Galileo observations
LOG COM2 RTCM1114 ONTIME 1 //output QZSS observations
LOG COM2 RTCM1124 ONTIME 1 //output BeiDou observations
LOG COM2 RTCM1230 ONTIME 10 //output GLONASS bias information
```

```
LOG COM2 RTCM1033 ONTIME 10 //output antenna, board information
SAVECONFIG //save the configuration above
```



Example of RTK configuration (rover mode):

```
UNLOGALL //remove all logs
FIX NONE //cancel the fixed coordinate of a base station
LOG GPGGA ONTIME 1 //output GPGGA to check position type
SAVECONFIG //save the configuration above
```

!	<p>The antenna of the base must be static and its position must be input, several ways can be used to input the position of the base:</p> <ul style="list-style-type: none">● If the base's position is known, input it directly with command FIX.● If the base's position is unknown, and the accuracy of the base can be meter-level, then it is recommended to use command POSAVE to setup the base, refer to the Log & Command document for more about this command. Please note the base's position will be different after a power cycle even if the antenna is installed at the same point if POSAVE command is input.● If you require a cm level accuracy of base and rover, then:<ol style="list-style-type: none">a. Configure the base board as a rover, receive RTK corrections from a CORS nearby, this board can get cm-level accuracy position.b. Collect raw measurements for half an hour, process it with post processing software or send the data to an online processing web, e.g. OPUS, to get an accurate position.
---	---

4.6 Data Collection on Internal eMMC

The BX50L-TAP board is embedded with up to 8GB internal eMMC chip, which brings convenience for data collection.

	Before data collection, please make sure enough space is available on the internal eMMC chip.
	The size of the logging:Collect raw measurements at 1Hz(about 110KByte/min if 20 satellites are tracked, about 165KByte/min if 30 satellites are tracked)If the collection frequency increases, the data size would increase proportionately.

The detailed steps for static data collection are as follows:

```

UNLOGALL                                     //remove all logs

LOG FILE RANGECMPB ONTIME 15.00 NOHOLD

//save the compressed version of the RANGE log

LOG FILE GPSEPHEMB ONCHANGED NOHOLD

//save the decoded GPS ephemeris.

LOG FILE BDSEPHEMERISB ONCHANGED NOHOLD

//save the decoded BDS ephemeris.

LOG FILE GLOEPHEMERISB ONCHANGED NOHOLD

//save the decoded GLONASS ephemeris.

LOG FILE GALINAVEPHEMERISB ONCHANGED NOHOLD

//save the decoded Galileo INAV ephemeris

LOG FILE QZSSEPHEMERISB ONCHANGED NOHOLD

//save the decoded QZSS ephemeris

SAVECONFIG                                   //save configuration
  
```

4.7 Download Files from Internal eMMC

The files saved on the internal eMMC chip can be copied to the computer via a USB port. Detailed steps to download files from eMMC chip are as follows:

- 1) Create a connection between a BX50L-TAP board and a computer via the cables below. Connect the COMM2 port of a BX50L-TAP board to the USB port of a computer using COMM2-7pin to USB & DB9 cable and DB9 Male to USB Type A Male converter cable.



Figure 4.10 COMM2-7pin to USB & DB9 Cable



Figure 4.11 DB9 Male to USB Type A Male converter cable

- 2) Power on the BX50L-TAP board.
- 3) A GNSS_U disk will display on the computer.
- 4) Open the GNSS_U disk and there are two folders: inner and user.
- 5) Copy the inner and user folders to see the related information from eMMC.

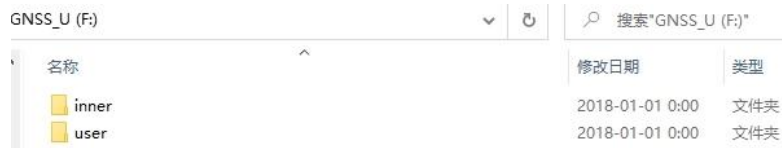

Figure 4.12 Folders in the GNSS_U disk



It is recommended to ensure the computer has available CPU and memory when downloading files.

4.8 Communicate with STRSVR Tool

The steps of BX50L-TAP communicating with STRSVR tool are as follows:

- 1) Power on the BX50L-TAP board, connect COM1 and COM2 to the computer. COM2 is to communicate with Tersus GNSS Center, COM1 is to receive RTK corrections from a NTRIP caster.
- 2) Run RTKLIB -> STRSVR, select serial for output type. And click the option button for serial port COM1 and configure it.

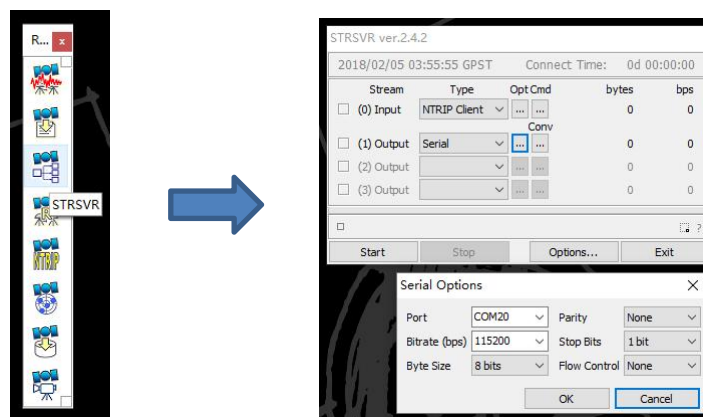

Figure 4.13 Configure serial port COM1

- 3) Select NTRIP client for input type, click the Opt button for NTRIP, and fill all the five fields for NTRIP client configuration.

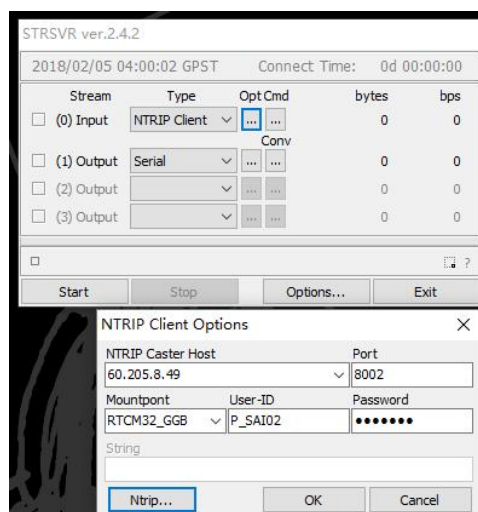

Figure 4.14 NTRIP client configuration

4) If needed, draft position of the board is input, refer to the following figure.

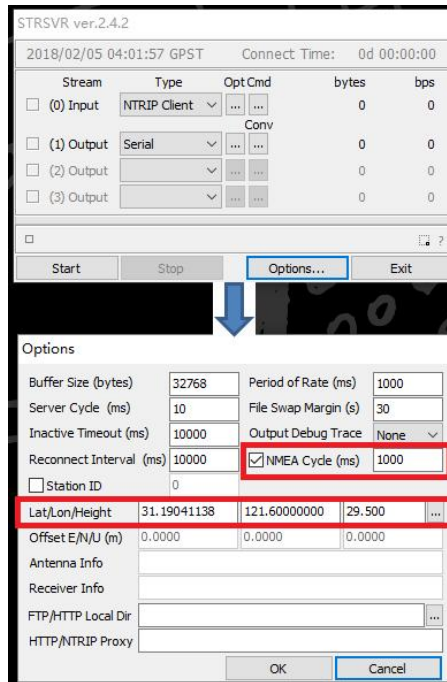

Figure 4.15 Draft position of the board

5) Go back to the main page, and click [Start]. If everything is OK the following page will be shown. The input and output data will increase with time. And the position type of the board can be checked in Tersus GNSS Center software.

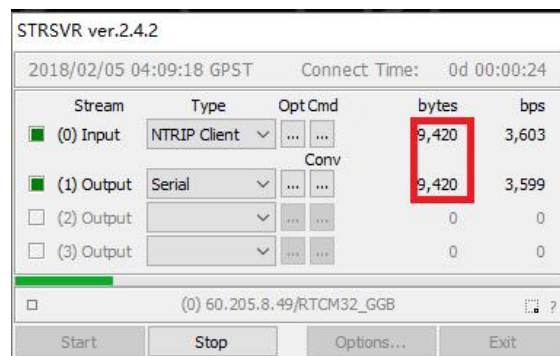

Figure 4.16 Input and Output data in progress

5. Terminology

ASCII	American Standard Code for Information Interchange
CMR	Compact Measurement Record
DC	Direct Current
ESD	Electro-Static Discharge
ECEF	Earth Center Earth Fixed
EGNOS	European Geostationary Navigation Overlay Service
GAGAN	GPS Aided Geo Augmented Navigation
GLONASS	GLObal NAVigation Satellite System
GNSS	Global Navigation Satellite System
GPS	Global Positioning System
IF	Intermediate Frequency
IMU	Inertial Measurement Unit
IO	Input / Output
LED	Light Emitting Diode
LNA	Low Noise Amplifier
MPU	Micro Processing Unit
NMEA	National Marine Electronics Association
PC	Personal Computer
PPS	Pulse Per Second
QZSS	Quasi-Zenith Satellite System
RF	Radio Frequency
RINEX	board Independent Exchange format
RMS	Root Mean Squares
RTK	Real-Time Kinematic

RTCM	Radio Technical Commission for Maritime Services
SBAS	Satellite-Based Augmentation System
SNR	Signal-to-Noise Ratio
SMA	Sub-Miniature-A interface
TTF	Time to First Fix
TTL	Transistor-Transistor Logic level
UART	Universal Asynchronous board/Transmitter
USB	Universal Serial BUS
UTC	Universal Time Coordinated
VRS	Virtual Reference Station
WAAS	Wide Area Augmentation System
WGS84	World Geodetic System 1984

Proprietary Notice

All Information in this document is subject to change without notice and does not reflect the commitment on Tersus GNSS Inc. No part of this manual may be reproduced or transmitted by all means without authorization of Tersus GNSS Inc. The software described in this document must be used in terms of the agreement. Any modification without permission from Tersus GNSS Inc. is not allowed.