

User Manual

Version V1.17-20211112



Nuwa App User Manual

©2021 Tersus GNSS Inc. All rights reserved.



Sales enquiry: sales@tersus-gnss.com

Technical Support: support@tersus-gnss.com

More details, please visit www.tersus-gnss.com

Revision History

Revision	Description	Date	Owner
1.0	Issued for Release	2018/08/08	LC
1.1	Added detailed description for device info and satellite info interfaces. Added predefined CRS for users to import Added Geoid CRS option Update section 4.7 Base Shift Added chapter for TC20 controller Added section 7.4 Issues and Solutions Other minor changes and fixes	2018/12/28	LC
1.2	Updated section 1.2 Installation; Added section 1.3 Update Nuwa; Updated cover photo; Updated section 7.2.2 File Downloading and section 7.2.3 Data Post Processing	2019/04/03	LC
1.3	Updated section 3.1 Connect	2019/05/29	LC
1.4	Updated screenshots in section 2.2 and 4; Added Oscar configuration in section 3.3 & 3.4; Added electronic bubble in section 3.5, 4.1 to 4.3; Updated section 5.2 to Azimuth Distance; Updated pictures in section 6.3 & 6.4 TC20 controller. Updated section 4.1 adding linework function.	2019/11/06	LC
1.5	Updated section 2.2.5 adding plane grid; Added SIMA format for import and export; Updated linework function for continued linework; Updated line stakeout function; Added report file function for detail point acquisition; Added L5 SNR display; Added display button for electronic bubble.	2019/12/02	LC
1.6	Added static record duration for static survey; Added NMEA output for Oscar; Added Point On Line Staking for line stakeout.	2020/01/03	LC
1.7	Added Tilt Survey and Stakeout	2020/02/28	LC
1.8	Added registration file name rules	2020/03/03	LC
1.9	Added DXF base map and shutting down Oscar when exiting Nuwa app	2020/04/08	LC
1.10	Updated section 2.6 Import	2020/04/23	LC
1.11	Updated Tersus logo; Updated registration process; Added road and road stakeout functions; Re-structure section 2.4 Point and section 2.5 Line.	2020/10/15	LC

1.12	<p>Added the functions of sharing point information via QR code and taking photos for the survey point;</p> <p>Added more formats for import and export;</p> <p>Added the selection of coordinate format display;</p> <p>Added simulation connection;</p> <p>Added call sign configuration for Oscar internal radio;</p> <p>Added functions of battery change, device log and satellite system setting when connecting Oscar;</p> <p>Added QR code registration; Staking line and line stake out classify to four circumstances; Added US feet; Added Greek, Bulgarian and Traditional Chinese;</p> <p>DXF base map has point stakeout and line stakeout;</p> <p>Road stakeout has options of by interval and by nearby; Added tools of earthwork, angular bisector, and grid to ground.</p>	2021/03/26	LC
1.13	<p>Added PPK survey mode; Added APN setting function and Device debug function in Oscar's device information</p>	2021/04/27	ZCG
1.14	<p>Added Area stakeout module and CAD stakeout module</p>	2021/07/02	ZCG
1.15	<p>Added selection point from map, control point measurement and road cross-section point survey</p>	2021/08/03	ZCG
1.16	<p>Added control point check point survey and PPK auto survey; added firmware version check and upgrade function in Oscar's device information; updated earthwork</p>	2021/09/27	ZCG
1.17	<p>Added the description of the new icons in the survey and stakeout interface; added the line close function; added the nearest point stakeout function; added the auto center and auto zoom functions; added Wifi setting and Lock device in Oscar's device information</p>	2021/11/12	ZCG

Table of Content

Revision History.....	ii
Table of Content.....	iv
List of Figures.....	viii
1. Nuwa Brief Introduction.....	1
1.1 Introduction.....	2
1.2 Installation.....	3
1.3 Update Nuwa.....	5
1.4 Main Interface.....	7
2. Project.....	12
2.1 Project.....	13
2.1.1 New.....	13
2.1.2 Import.....	14
2.1.3 Open.....	15
2.1.4 Delete.....	16
2.1.5 Edit Project Property.....	16
2.2 CRS (CooRdinate System).....	18
2.2.1 New CRS.....	19
2.2.2 Import CRS.....	26
2.2.3 Edit CRS.....	29
2.2.4 Delete CRS.....	29
2.2.5 Plane Grid and Geoid.....	30
2.3 Parameters.....	32
2.4 Point.....	35
2.4.1 Survey Point.....	35
2.4.2 Control Point.....	39
2.4.3 Staking Point.....	44
2.5 Line.....	48

2.5.1 Survey Line.....	48
2.5.2 Staking Line.....	55
2.6 Road.....	59
2.6.1 Add new road.....	59
2.6.2 Edit road.....	62
2.6.3 Delete road.....	63
2.6.4 Import/Export road.....	63
2.7 Import.....	64
2.7.1 Coordinate Import.....	64
2.7.2 Other Import.....	68
2.8 Export.....	69
2.8.1 Coordinate Export.....	70
2.8.2 Other Export.....	71
2.9 Settings.....	74
3. Device.....	76
3.1 Connect.....	77
3.2 Data Terminal.....	83
3.3 Base.....	87
3.3.1. Set David as a Base.....	88
3.3.2. Set Oscar as a Base.....	92
3.4 Rover.....	96
3.4.1. Set David as a Rover.....	96
3.4.2. Set Oscar as a Rover.....	99
3.5 NMEA Output.....	102
3.6 Device.....	103
3.6.1 David's device information.....	103
3.6.2 Oscar's device information.....	104
4. Survey.....	110
4.1 Survey.....	111

4.2 Point Stakeout.....	117
4.3 Line Stakeout.....	119
4.4 Tilt Survey and Stakeout.....	123
4.4.1 Tilt Initialization.....	123
4.4.2 Tilt Survey.....	125
4.4.3 Tilt Stakeout.....	127
4.5 Static Survey.....	128
4.5.1 Static data download for David.....	129
4.5.2 Static data download for Oscar.....	133
4.5.3 Data post-processing.....	135
4.6 Point Correction.....	137
4.6.1 Four Parameter.....	138
4.6.2 Height Fitting.....	138
4.6.3 Four Parameter + Height Fitting.....	138
4.6.4 Application Example.....	138
4.7 Survey Config.....	142
4.7.1 Common Config.....	142
4.7.2 Display Config.....	146
4.8 Base Shift.....	147
4.9 Road Stakeout.....	149
4.10 Area Stakeout.....	152
4.11 CAD Stakeout.....	153
5. Tools.....	157
5.1 Area Perimeter.....	159
5.2 Azimuth Distance.....	159
5.2.1 Point to Point Distance.....	160
5.2.2 Point to Line Distance.....	160
5.3 Offset Point.....	161
5.3.1 Offset point.....	161

5.3.2 Offset point from line.....	162
5.4 Rotation Point.....	163
5.5 Two Points Intersection.....	164
5.6 Four Points Intersection.....	165
5.7 Intersection Angle.....	166
5.8 Earthwork.....	166
5.9 Angular Bisector.....	169
5.10 Grid to Ground.....	169
5.11 Line Segmentation.....	171
5.12 Points Avg.....	172
6. TC20 Controller and application.....	174
6.1 Overview of TC20 Controller.....	174
6.2 Outlook of TC20 Controller.....	175
6.3 Accessories of TC20 Controller.....	176
6.4 General Operations.....	177
6.4.1 Insert SIM card and Micro SD card.....	177
6.4.2 Micro SD card.....	180
6.4.3 Using of Touch Screen.....	181
7. Technical Appendix.....	182
7.1 Quick Start.....	182
7.2 Issues and Solutions.....	185
8. Terminology.....	191
9. File Format.....	192

List of Figures

Figure 1.1	Nuwa in Google Play Store.....	3
Figure 1.2	Nuwa in Google Play Store – install	3
Figure 1.3	Nuwa in Google Play Store – open	4
Figure 1.4	Nuwa copied in an android device.....	4
Figure 1.5	Nuwa icon on desktop.....	4
Figure 1.6	Update Nuwa in Google Play Store – 1	5
Figure 1.7	Update Nuwa in Google Play Store – 2	5
Figure 1.8	Version in Settings page.....	6
Figure 1.9	Software Update notification.....	6
Figure 1.10	Nuwa Main Interface.....	7
Figure 1.11	Satellite Info – Position.....	8
Figure 1.12	Satellite Info – Skymap.....	9
Figure 1.13	Satellite Info – CN0 L1.....	10
Figure 1.14	Satellite Info – CN0 L2.....	10
Figure 1.15	Satellite Info – CN0 L5.....	11
Figure 1.16	Satellite Info – Sat Tab.....	11
Figure 2.1	Functions under Project.....	12
Figure 2.2	Create Project interface.....	13
Figure 2.3	New project created.....	14
Figure 2.4	Project folders in an Android device.....	15
Figure 2.5	Sketch file containing the project info.....	15
Figure 2.6	Open an existing project.....	16
Figure 2.7	Delete Project.....	16
Figure 2.8	Project List.....	17
Figure 2.9	Project Property.....	17
Figure 2.10	Share Project Info.....	18
Figure 2.11	Coordinate System List.....	19

Figure 2.12	Create a new CRS.....	19
Figure 2.13	Ellipsoid list.....	20
Figure 2.14	Projection interface.....	20
Figure 2.15	Projection list.....	21
Figure 2.16	Datum transformation options.....	22
Figure 2.17	Bursa Parameters.....	22
Figure 2.18	Plane adjustment interface.....	23
Figure 2.19	Plane adjustment options.....	23
Figure 2.20	4 Parameters.....	23
Figure 2.21	Height fitting interface.....	24
Figure 2.22	Parameters fitting options.....	24
Figure 2.23	Height Fitting – Parameters Fitting.....	24
Figure 2.24	Scan QR code to get CRS info.....	25
Figure 2.25	CRS info obtained by scanning QR code.....	26
Figure 2.26	Predefined CRS.....	26
Figure 2.27	Continent options.....	27
Figure 2.28	Preview of predefined CRS.....	27
Figure 2.29	Example of CRS import.....	28
Figure 2.30	Edit Coordinate System.....	29
Figure 2.31	Delete CRS.....	29
Figure 2.32	Plane Grid list.....	30
Figure 2.33	Plane Grid download list.....	30
Figure 2.34	Geoid list.....	31
Figure 2.35	Geoid download list.....	31
Figure 2.36	Explore Geoid folder in the android device.....	31
Figure 2.37	Refresh to view the Geoid list.....	32
Figure 2.38	Parameters Calculation.....	33
Figure 2.39	Add Point for calculation.....	33
Figure 2.40	Parameters Calculation Result interface.....	34

Figure 2.41	Survey Point Interface.....	35
Figure 2.42	Add survey point.....	35
Figure 2.43	Edit survey point.....	36
Figure 2.44	View details of survey point.....	37
Figure 2.45	Point Query interface.....	38
Figure 2.46	Pop-up notice before deletion.....	39
Figure 2.47	Control Point interface.....	40
Figure 2.48	Import Data info.....	40
Figure 2.49	Data format list.....	41
Figure 2.50	Import Survey Point.....	41
Figure 2.51	Add Control Point.....	42
Figure 2.52	Edit Control Point interface.....	42
Figure 2.53	Control Point interface.....	43
Figure 2.54	Point Query interface.....	43
Figure 2.55	Delete control point.....	44
Figure 2.56	Staking Point interface.....	44
Figure 2.57	Import source for Staking Point.....	45
Figure 2.58	Import from Survey Point.....	45
Figure 2.59	Control Point interface.....	46
Figure 2.60	Edit staking point.....	46
Figure 2.61	Query staking point.....	47
Figure 2.62	Line interface.....	48
Figure 2.63	Add survey line interface.....	48
Figure 2.64	Select two points from survey point library – 1	49
Figure 2.65	Select two points from survey point library – 2	49
Figure 2.66	Survey line added.....	50
Figure 2.67	Survey line in survey interface.....	50
Figure 2.68	Edit a survey line 2.....	51
Figure 2.69	Add PT5 to the line end.....	52

Figure 2.70	The new Line2 in survey interface.....	52
Figure 2.71	Add PT5 before PT6.....	52
Figure 2.72	The new Line2 in survey interface.....	52
Figure 2.73	Delete PT5 in Line2.....	53
Figure 2.74	Line2 after deleting PT5.....	53
Figure 2.75	Line Query interface.....	53
Figure 2.76	Survey line interface.....	54
Figure 2.77	Tick the line to be deleted.....	54
Figure 2.78	Four types of staking line.....	55
Figure 2.79	Add line method 1.....	55
Figure 2.80	Add line method 2.....	55
Figure 2.81	Add arc method 1.....	57
Figure 2.82	Add arc method 2.....	57
Figure 2.83	Add circle method 1.....	58
Figure 2.84	Add circle method 2.....	58
Figure 2.85	Road interface.....	59
Figure 2.86	Add Road interface.....	60
Figure 2.87	Road feature factor options.....	60
Figure 2.88	Road interface.....	62
Figure 2.89	Edit an existing road.....	62
Figure 2.90	Change method when editing road.....	63
Figure 2.91	Export road file.....	64
Figure 2.92	Import interface.....	65
Figure 2.93	Import Type.....	65
Figure 2.94	Target Point Library.....	66
Figure 2.95	Data Format options.....	66
Figure 2.96	File Format options.....	67
Figure 2.97	Import Line interface.....	67
Figure 2.98	Example content in the .Inb file.....	68

Figure 2.99	Other Import interface.....	68
Figure 2.100	File format for other import.....	69
Figure 2.101	Target point options.....	69
Figure 2.102	Export Interface.....	70
Figure 2.103	Data Format options.....	70
Figure 2.104	User defined data.....	71
Figure 2.105	Create data format.....	71
Figure 2.106	Manage data format.....	71
Figure 2.107	Other Export interface.....	72
Figure 2.108	File Format for other export.....	72
Figure 2.109	Export XML file.....	73
Figure 2.110	Preview of the XML file in text mode.....	73
Figure 2.111	Settings interface	74
Figure 2.112	Check if shut down Oscar.....	75
Figure 3.1	Functions under Device.....	76
Figure 3.2	Device functional group.....	77
Figure 3.3	Connect interface – David	77
Figure 3.4	Connect interface – Oscar	78
Figure 3.5	Two connection types for David.....	78
Figure 3.6	Bluetooth searching.....	79
Figure 3.7	Bluetooth is pairing.....	79
Figure 3.8	Bluetooth paired.....	80
Figure 3.9	Connect interface – Oscar	80
Figure 3.10	Connect interface – NMEA.....	81
Figure 3.11	Antenna Manage interface.....	81
Figure 3.12	Parameters for New Antenna.....	82
Figure 3.13	Antenna parameters explanation.....	82
Figure 3.14	Simulation connection interface.....	83
Figure 3.15	Data Terminal interface.....	84

Figure 3.16	Data Terminal outputs hex data.....	84
Figure 3.17	Create File Name.....	85
Figure 3.18	Start recording log data.....	85
Figure 3.19	Stop recording log data.....	86
Figure 3.20	Common Command.....	86
Figure 3.21	David base auto start – Radio.....	88
Figure 3.22	Baud rate options.....	89
Figure 3.23	David base auto start – Ntrip.....	90
Figure 3.24	David base auto start – TCP	90
Figure 3.25	David base auto start – TCS.....	90
Figure 3.26	Ntrip Site Manager.....	90
Figure 3.27	David base manual start – Radio.....	91
Figure 3.28	David base manual Start – Network.....	92
Figure 3.29	Oscar base auto start – 4 data link options.....	93
Figure 3.30	Oscar base auto start – internal radio.....	94
Figure 3.31	Oscar base auto start – receiver network options.....	95
Figure 3.32	Oscar base auto start – Ntrip network.....	95
Figure 3.33	Oscar base auto start – TCP network.....	95
Figure 3.34	Oscar base auto start – TCS network.....	95
Figure 3.35	Oscar base auto start – PDA network options.....	96
Figure 3.36	Create Rover Configuration for David – Radio.....	97
Figure 3.37	Create Rover Configuration for David – Ntrip Network.....	97
Figure 3.38	Protocol type options.....	98
Figure 3.39	Edit Rover Configuration.....	98
Figure 3.40	Create Rover configuration for David – TCP Network.....	99
Figure 3.41	Create Rover configuration for David – TCS network.....	99
Figure 3.42	Create Rover Configuration for Oscar – Internal Radio.....	100
Figure 3.43	Oscar rover data link options.....	100
Figure 3.44	Oscar rover using receiver network – protocol options.....	101

Figure 3.45	Oscar rover using PDA network – protocol options.....	101
Figure 3.46	NMEA output configuration.....	102
Figure 3.47	NMEA baud rate options.....	102
Figure 3.48	David’s device info.....	103
Figure 3.49	Example of David’s registration file.....	104
Figure 3.50	Oscar’s device info.....	105
Figure 3.51	eBubble before adjusting.....	107
Figure 3.52	eBubble after adjusting.....	107
Figure 3.53	Example of Oscar’s registration file.....	109
Figure 4.1	Functions under Survey.....	110
Figure 4.2	Survey – Drawing mode.....	111
Figure 4.3	Survey – Text mode.....	111
Figure 4.4	Map options.....	113
Figure 4.5	DXF file list.....	113
Figure 4.6	Prompt to stakeout the point.....	113
Figure 4.7	Switch to point stakeout.....	113
Figure 4.8	Prompt to stakeout the line.....	114
Figure 4.9	Switch to line stakeout.....	114
Figure 4.10	Enter an existing line name.....	115
Figure 4.11	Continue the existing line options.....	115
Figure 4.12	Information option list – part 1.....	116
Figure 4.13	Information option list – part 2.....	116
Figure 4.14	Point Stakeout interface.....	117
Figure 4.15	Add stakeout point.....	118
Figure 4.16	Configure straight line stakeout.....	119
Figure 4.17	Stakeout a straight line.....	119
Figure 4.18	Configure polyline stakeout.....	120
Figure 4.19	Stakeout a polyline.....	120
Figure 4.20	Configure arc stakeout.....	120

Figure 4.21	Stakeout an arc.....	120
Figure 4.22	Configure arc stakeout.....	121
Figure 4.23	Stakeout a circle.....	121
Figure 4.24	Enable Tilt in device info.....	124
Figure 4.25	Setting antenna height when enabling tilt compensation.....	124
Figure 4.26	Detailed information of tilt compensation.....	125
Figure 4.27	Tilt status is ON.....	126
Figure 4.28	Point stakeout when tilt compensation is on.....	127
Figure 4.29	Static Survey interface.....	128
Figure 4.30	Duration options.....	128
Figure 4.31	Static data recording.....	129
Figure 4.32	Preparation for Static Data Process.....	130
Figure 4.33	Connections of David, computer and power bank.....	130
Figure 4.34	TersusDownload interface.....	131
Figure 4.35	Download speed options.....	131
Figure 4.36	File selected for download.....	132
Figure 4.37	View antenna height in the RINEX file.....	133
Figure 4.38	Connect Oscar to a computer.....	133
Figure 4.39	Static data recorded by Oscar.....	134
Figure 4.40	Tersus Rinex Converter interface.....	134
Figure 4.41	The Rinex files after conversion.....	135
Figure 4.42	TERSUS Geomatics Office interface.....	135
Figure 4.43	Import Files in TERSUS Geo Office.....	135
Figure 4.44	Default configuration of the observation data.....	136
Figure 4.45	Calculation Type options.....	137
Figure 4.46	Height Fitting options.....	137
Figure 4.47	Application example for point correction.....	139
Figure 4.48	Add point for point correction.....	139
Figure 4.49	The 1 st pair of points for calculation.....	140

Figure 4.50	The 2 nd pair of points for calculation.....	140
Figure 4.51	Two pairs of points for calculation.....	140
Figure 4.52	Calculation Result.....	141
Figure 4.53	Point correction results applied to current project.....	141
Figure 4.54	Slide left to view residual results.....	142
Figure 4.55	Updated project property after point correction.....	142
Figure 4.56	Survey Config - Detail.....	143
Figure 4.57	Survey Config – Continuous.....	143
Figure 4.58	Survey Config – Display Config.....	146
Figure 4.59	Survey Point Color.....	147
Figure 4.60	Advanced Config for Display Config.....	147
Figure 4.61	Base Shift interface – 1.....	148
Figure 4.62	Base Shift interface – 2.....	149
Figure 4.63	Road stakeout interface.....	150
Figure 4.64	Road data is loading.....	150
Figure 4.65	Road stakeout setting.....	151
Figure 4.66	Road stakeout setting.....	152
Figure 4.67	Area stakeout.....	153
Figure 4.68	Select CAD file.....	154
Figure 4.69	CAD stakeout.....	155
Figure 5.1	Functions under Tools.....	158
Figure 5.2	Area Perimeter interface.....	159
Figure 5.3	Azimuth Distance – Point to Point	160
Figure 5.4	Azimuth Distance – Point to Line.....	160
Figure 5.5	Offset Point interface.....	161
Figure 5.6	Offset Point calculation result.....	161
Figure 5.7	Offset point from line.....	162
Figure 5.8	Offset point from line calculation result.....	162
Figure 5.9	Rotation Point interface.....	163

Figure 5.10	Rotation Point Calculation result.....	163
Figure 5.11	Two Point Intersection – Angle.....	164
Figure 5.12	Two Point Intersection – Distance.....	164
Figure 5.13	Four Point Intersection interface.....	165
Figure 5.14	Four Point Intersection result.....	165
Figure 5.15	Intersection Angle calculation.....	166
Figure 5.16	Select all surface points to be calculated.....	167
Figure 5.17	Select the boundary points.....	167
Figure 5.18	File name and storage path for the earthwork.....	168
Figure 5.19	Earthwork calculation result	168
Figure 5.20	Intersection Angle calculation.....	169
Figure 5.21	Grid to Ground interface.....	170
Figure 5.22	Calculate the correction factors.....	170
Figure 5.23	Point detail after applying the calculation.....	171
Figure 5.24	Line Segmentation.....	172
Figure 5.25	Points Avg.....	173
Figure 6.2	TC20 Lithium battery.....	176
Figure 6.3	TC20 Charger Adapter.....	176
Figure 6.4	TC20 Charger Adapter Plugs.....	176
Figure 6.5	TC20 Controller hand strap.....	177
Figure 6.6	Stylus Pen for TC20.....	177
Figure 6.7	Mini USB cable.....	177
Figure 6.8	Remove the back cover.....	178
Figure 6.9	Take off the back cover.....	178
Figure 6.10	Put the SIM card in the holder.....	179
Figure 6.11	Insert Micro SD card.....	179
Figure 6.12	Insert the back cover.....	180
Figure 6.13	Select USB function.....	181

1. Nuwa Brief Introduction

- Introduction
- Installation
- Update Nuwa
- Main Interface

1.1 Introduction

Nuwa is a survey application software based on Android OS (Operating System), designed by and all rights reserved to Tersus Inc. Nuwa is simple, easy to use and has friendly UI (User Interface). It is designed to work with Tersus products including David GNSS receiver, Oscar GNSS receiver, BX series OEM boards and other receivers which support NEMA-0183.

Main features of Nuwa App:

- Supports Bluetooth/USB connection and related operations for Tersus receivers.
- Powerful data management makes survey data management more convenient. Easy for data editing and import / export of several types of formats.
- Convenient to set up a base station or a rover, and supports setting to transmit and receive differential data through the radio, receiver network or PDA network.
- Optimized survey and stakeout, supports GNSS Linework and road stakeout, more functions, and more simple operation.
- Built-in a variety of ellipsoids and projections, various languages and national coordinate systems. Supports user-defined coordinate system which is more adaptable.
- Provide tools for indirect measurement for easier work.
- Supports new release detection and online upgrades.

1.2 Installation

There are two methods of installing Nuwa app in an android device.

- 1) Search Nuwa in Google Play Store, click [Install], install the application and open it after the installation is completed. The screenshots are as follows.

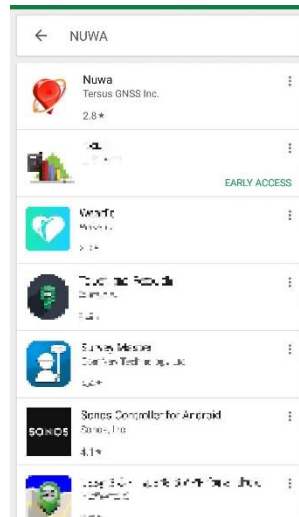

Figure 1.1 Nuwa in Google Play Store

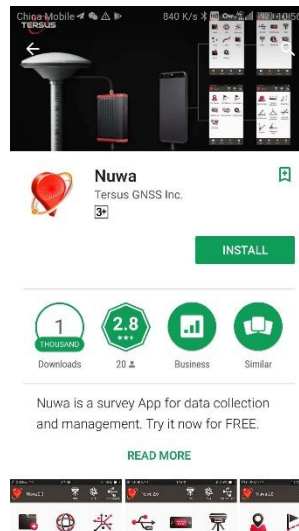

Figure 1.2 Nuwa in Google Play Store – install

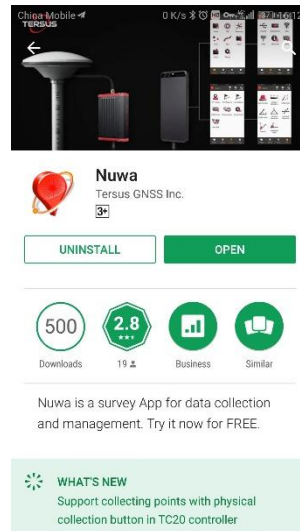

Figure 1.3 Nuwa in Google Play Store – open

- 2) Copy the .apk file to the storage of an Android device, click it to start installation. The Nuwa icon will be on the desktop after it is installed successfully.

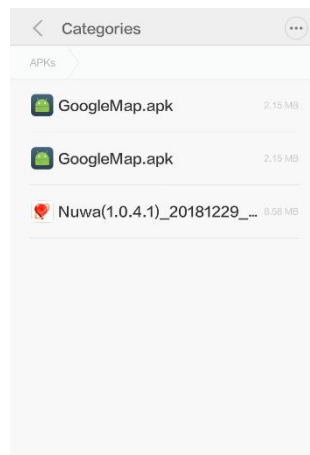

Figure 1.4 Nuwa copied in an android device

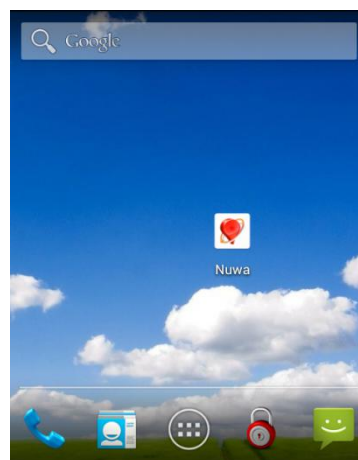

Figure 1.5 Nuwa icon on desktop

1.3 Update Nuwa

There are three methods of updating Nuwa app in an android device.

- 1) Update Nuwa in Google Play Store which is shown below.

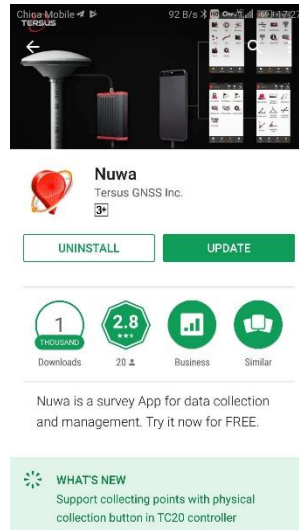

Figure 1.6 Update Nuwa in Google Play Store – 1

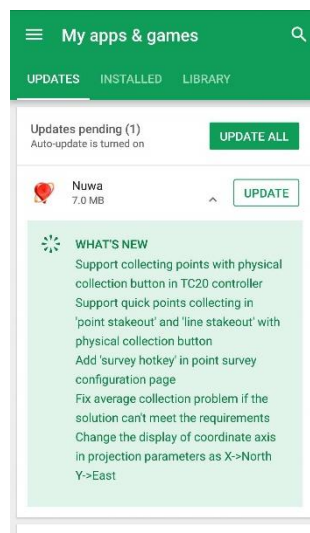

Figure 1.7 Update Nuwa in Google Play Store – 2

- 2) Update Nuwa by copying the latest .apk installation file to the storage of an android device. The process is the same with that in the above section of installation.
- 3) Update Nuwa in the 'Settings' page inside Nuwa app. In the condition that the android device is connected to internet and [Update Detection] is turned on, it automatically pops up an update prompt every time you open Nuwa and it can be seen that there is red 'new' on the right of version number if current Nuwa version is detected to be ready to update.

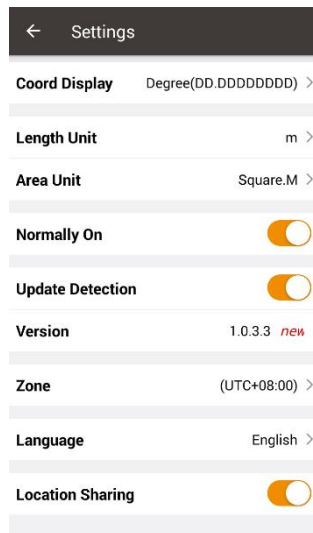

Figure 1.8 Version in Settings page

If [Update Detection] is not turned on, tap the row of version, it pops out a window indicating software update. Select [Update] to update the app automatically. Select [Later] to ignore this notification.

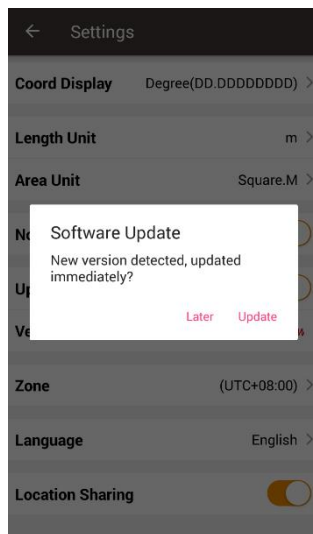

Figure 1.9 Software Update notification

1.4 Main Interface

Nuwa has four main functional groups: Project, Device, Survey and Tools. While Nuwa is running, slide left or right on the screen to enter other functional groups.

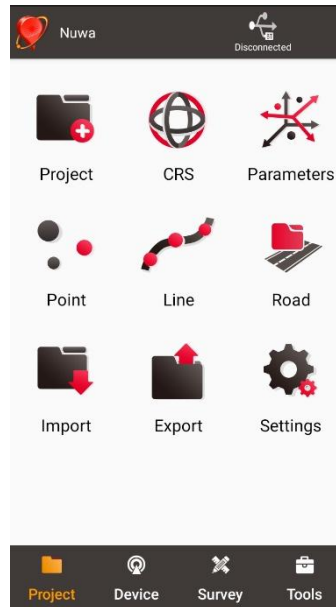





Figure 1.10 Nuwa Main Interface

➤ Status Bar

: Project Information, the current project name is displayed.

: Device information, when a device is connected, click it to check details about the receiver connected. Refer to section 3.6 for detailed description.

: Satellites status, when a device is connected, it displays satellite positioning status which includes: None, Single, DGPS, Float and Fixed. Click this icon to view satellite information which is shown in the figures below.

: Connection status, if there is no device connected, it displays Disconnected. Click this icon to enter connect interface, refer details in section 3.1. If there is a device connected, this icon displays the 2D and 3D accuracy of current connected device.

➤ Menu area

List all the menu items in the current functional group.

➤ Tabs Bar

Four functional groups: Project, Device, Survey and Tools.

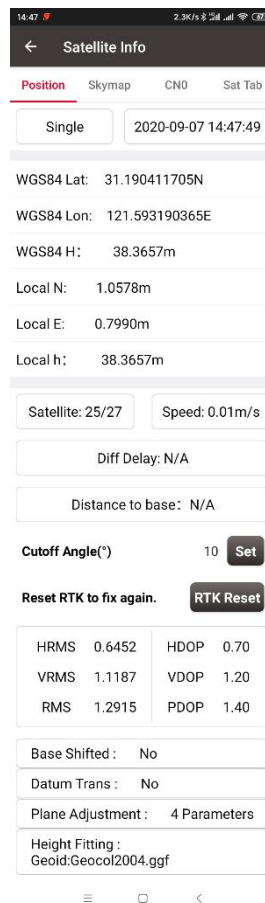

Figure 1.11 Satellite Info – Position

In the figure above, 'Single' indicates the current solution status of the receiver. The solution status includes Fixed, Float, DGPS, Single, Base Manual and Base Auto.

Clicking the box of date and time can switch time zone, clicking 'WGS84 Lat' or 'WGS84 Lon' can switch display from options of Degree (DD.DDDDDD), DM (DD:MM.MMMM) and DMS (DD:MM:SS.SS), clicking 'WGS84 H' or 'Local N' or 'Local E' or 'Local h' can switch unit from options of km, m, inch, and feet.

'Satellite: 22/24' indicates that 22 satellites used and 24 satellites observed / tracked.

'Speed: 0.01m/s' is the moving speed of the receiving antenna.

'Diff Delay: 1' indicates that the differential delay is 1 second.

'Distance to base: 1.52m' means the distance between rover and base is 1.52m.

Elevation Mask Angle can be set between 0 and 90 degrees. Modifying the elevation mask angle does not show a change in the number of satellites observed and used.

HRMS, VRMS and RMS indicate the horizontal, vertical and total value of root mean

square.

HDOP, VDOP and PDOP indicate the horizontal, vertical and position of dilution of precision.

The last four rows of this interface present the status of base shift, datum transformation, plane adjustment and height fitting.

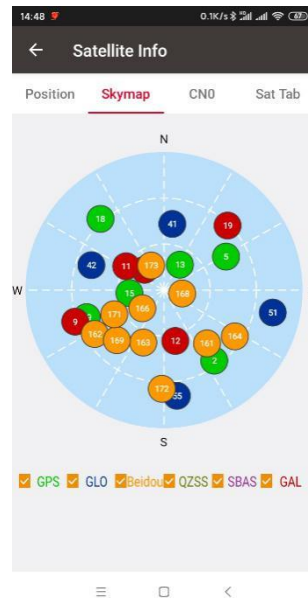

Figure 1.12 Satellite Info – Skymap

In the figure above, the sky map displays the elevation angle and azimuth of satellites of different satellite systems. A satellite at the center of the circle means its elevation angle is 90 degrees, a satellite on the circumference means its elevation angle is 0 degree. At the bottom of this interface, one or more constellations can be ticked to display.

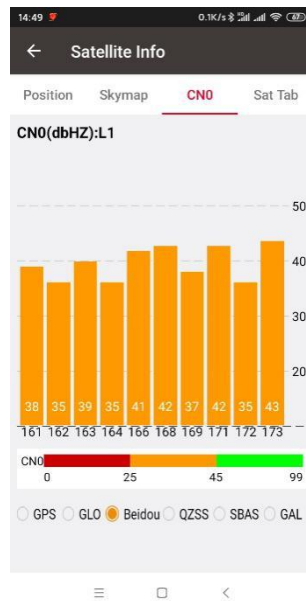

Figure 1.13 Satellite Info – CN0 L1

In the figure above, it shows the CNR (Carrier Noise Ratio) of different satellites in specified constellation. Clicking the histogram area can switch the CN0 between L1, L2 and L5.



Figure 1.14 Satellite Info – CN0 L2



Figure 1.15 Satellite Info – CNO L5

Type	Prn	Azi	Ele	L1	L2	L5	Lock
GPS	2	145	32	39	32	0	Used
GPS	5	62	43	41	40	0	Used
GPS	13	31	69	43	38	0	Used
GPS	15	266	67	44	43	0	Used
GPS	18	318	28	38	30	41	Used
GPS	29	249	36	40	37	0	Used
GLONASS	41	8	46	39	43	0	Used
GLONASS	42	790	40	41	42	0	Used
GLONASS	51	100	16	38	38	0	Used
GLONASS	55	173	19	36	34	0	Used
BeiDou	161	141	45	38	44	40	Used
BeiDou	162	237	36	35	42	38	Used
BeiDou	163	201	53	39	45	41	Used
BeiDou	164	123	34	35	41	38	Used
BeiDou	166	230	71	41	46	43	Used
BeiDou	168	102	77	42	47	44	Used
BeiDou	169	223	45	37	44	40	Used
BeiDou	171	742	53	42	48	46	Used
BeiDou	172	181	24	35	42	40	Used
BeiDou	173	331	72	43	46	43	Used
Galileo	4	318	71	43	48	46	Used
Galileo	9	259	29	37	42	40	Used
Galileo	11	201	61	39	44	41	Used
Galileo	12	167	55	38	45	42	Used
Galileo	19	44	30	32	37	33	Used

Figure 1.16 Satellite Info – Sat Tab

In the figure above, it shows the satellite information in table which including satellite type, PRN code, azimuth, elevation angle, CNO value of L1, CNO value of L2, CNO value of L5 and satellite using status.

2. Project

- Project
- CRS (CooRdinate System)
- Parameters
- Point
- Line
- Road
- Import
- Export
- Settings

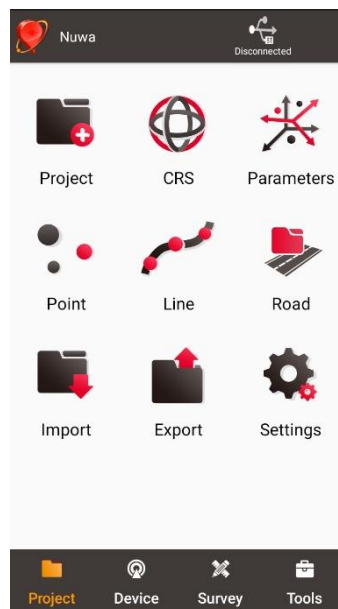

Figure 2.1 Functions under Project

2.1 Project

This section introduces how to create a new project, open / delete / edit an existing project.

2.1.1 New

A new project is necessary to manage all the data. On the Nuwa main interface as shown in Figure 1.10, click [Project] - > [New] to go to the following interface.

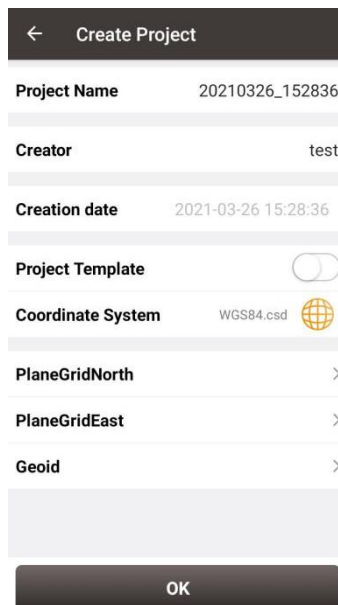

Figure 2.2 Create Project interface

[Project Name]: input the project name

[Creator]: input the name of the operator

[Creation date]: the date and time generates automatically.

[Project Template]: use an existing project settings

[Coordinate System]/ [Source Project]: select a coordinate system if project template is not turned on; select a source project if using a project template.

[PlaneGridNorth]: select plane grid in the list, or click More to download more grid file online.

[PlaneGridEast]: select plane grid in the list, or click More to download more grid file online.

[Geoid]: select geoid model in the list, or click More to download more geoid file online.

Note: (1) If the grid file or geoid file is already selected in the parameters of the selected coordinate system, the selected grid file or geoid file will be automatically filled in below when the new project is created.

(2) If the grid file or geoid file is selected here, they will be applied to this project after new project is successfully created.

(3) If the grid file or geoid file is selected here, but the file is actually not available in the controller InternalStorage\TersusSurvey related path, then it will be prompt that the file is not found when the new project is successfully created.

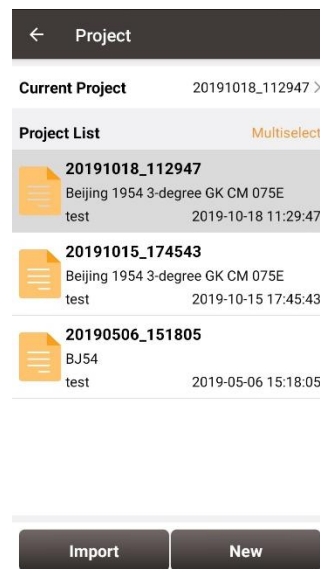

Figure 2.3 New project created

After a project is created, it will prompt out a window asking whether close the current project and open the newly created project. The projects in the list are sorted in reverse chronological order. Refer to section 2.1.5 for more details about project property.

2.1.2 Import

In the Figure 2.3, an existing project can be imported from the storage of the android device by clicking [Import] on the bottom left of the interface.

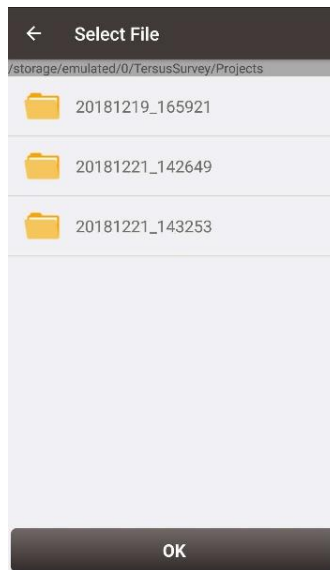

Figure 2.4 Project folders in an Android device

When importing projects from other sources, click [Import], select the Project folder under TersusSurvey which is shown in Figure 2.4, and click [OK] and Nuwa imports all the projects in this folder.

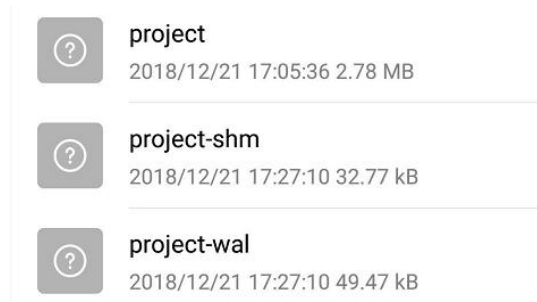

Figure 2.5 Sketch file containing the project info

Note: The imported project file should have a sketch file containing the project information (Project / Project-shm / Project-wal).

2.1.3 Open

If there is need to operate in an existing project, find it in the project list and click it. Nuwa prompts to open the project, click [OK].

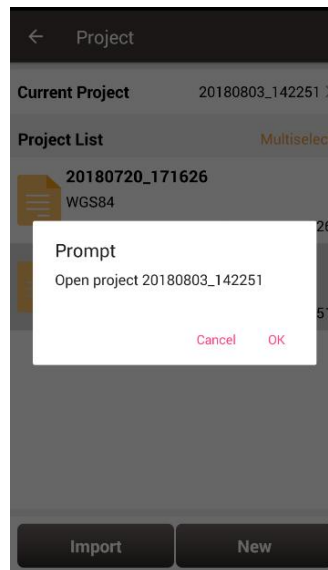

Figure 2.6 Open an existing project

2.1.4 Delete

Click [Multiselect] at the right side of Project List, select (single select, inverse select or select all) projects to be deleted. After the projects are selected, click [Delete] button to delete them. Nuwa prompts to confirm, click [OK] to complete the deletion.

Note: The current Project cannot be deleted in Nuwa app.

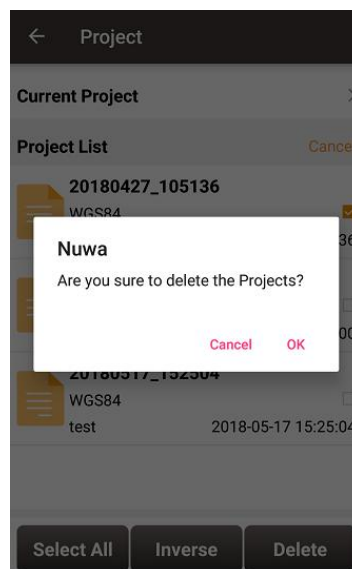

Figure 2.7 Delete Project

2.1.5 Edit Project Property

If a project is opened, the coordinate system can be edited, including ellipsoid, projection

method and coordination transformation.

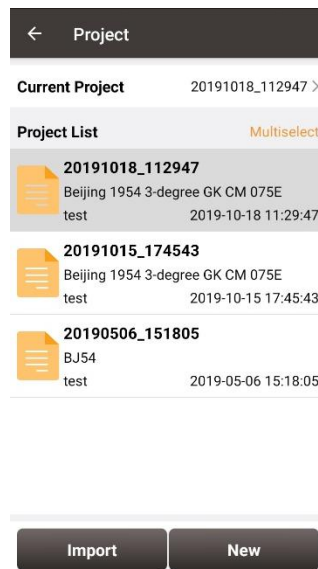

Figure 2.8 Project List

Click the [Current Project] to enter Project Property interface.

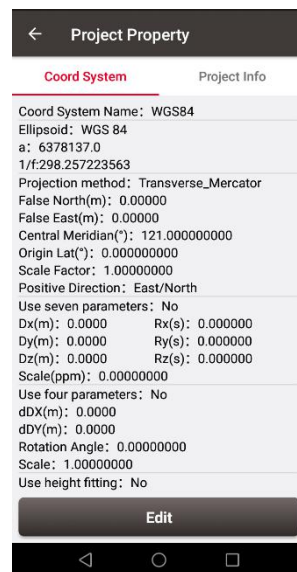

Figure 2.9 Project Property

Click [Edit] to input the ellipsoid parameters, projection type and coordination transformation, refer to section 2.2.2 for details.



Figure 2.10 Share Project Info

Click [Share] to share the project parameters with others. The detailed usage refers to section 2.2.1.

2.2 CRS (CooRdinate System)

Nuwa app supports user-defined coordinate system. A user-defined coordinate system can be saved as a template. A CRS can be created, imported, edited and deleted in the CRS management interface.

On the Nuwa main interface as shown in Figure 1.10, click [CRS] to get the coordinate system list which is shown below.



Figure 2.11 Coordinate System List

2.2.1 New CRS

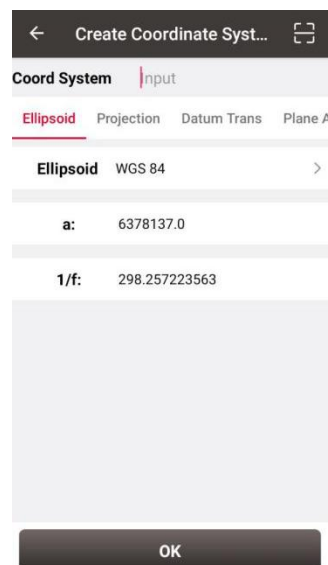

Figure 2.12 Create a new CRS

Click [New] to create a new CRS, input the coordinate system name, select the right ellipsoid, projection, datum transformation, plane adjustment, and height fitting as per the following screenshots:

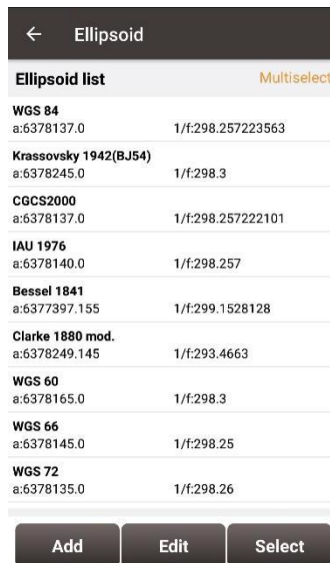

Figure 2.13 Ellipsoid list

[Ellipsoid]: Select the correct ellipsoid parameters, including ellipsoid name, semi-major axis, inverse flattening, etc. For a predefined ellipsoid, it automatically fills the semi-major axis and inverse flattening after selecting the ellipsoid; if the ellipsoid that meets the requirements is not found in the predefined ellipsoid, and you have the parameters of the ellipsoid, you can [Add] an ellipsoid to the list, enter your parameters and select it; If the ellipsoid that meets the requirements is not found in the predefined ellipsoid and you do not have the parameters for this ellipsoid, please contact Tersus technical support.

Note: The default ellipsoid is WGS84.

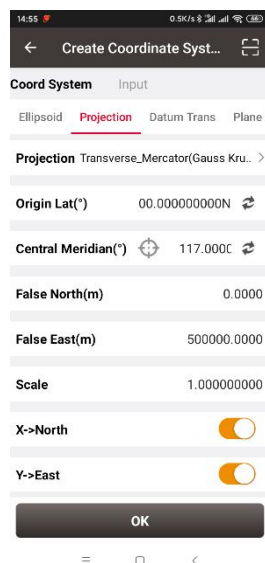



Figure 2.14 Projection interface

[Projection]: Including Transverse Mercator, UTM, Lambert conformal conic 1SP, Lambert

conformal conic 2SP, and etc. When a receiver is connected with Nuwa, click the icon  to round the current longitude as the central meridian. The projection is listed as below, if the required projection is not found in the predefined projection list, please contact Tersus technical support.

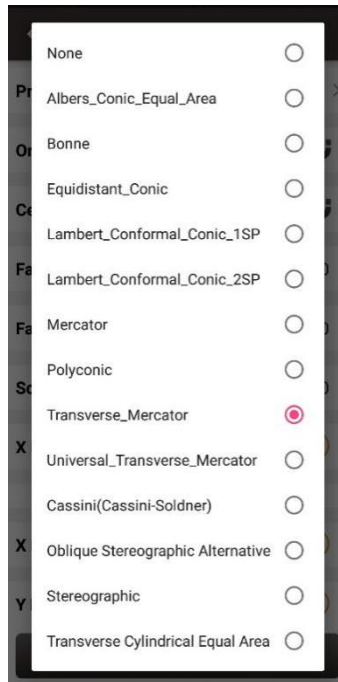

Figure 2.15 Projection list

Origin latitude, central meridian and other parameters can also be configured in Projection interface which is shown above. Fill in these information according to the actual needs. Turn on [X -> North] to indicate that the positive part of X axis is north, negative part is south. Turn on [Y -> East] to indicate that the positive part of Y axis is east, negative part is west.

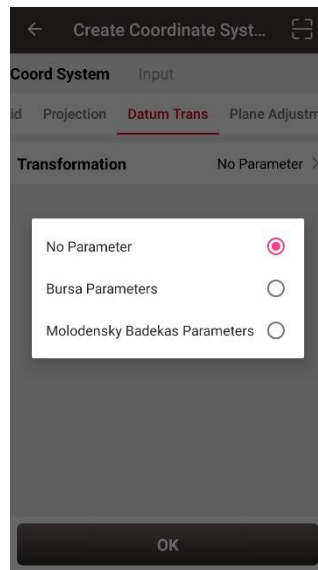

Figure 2.16 Datum transformation options

[Datum Transformation]: Datum transformation is necessary when the source ellipsoid is different from the target ellipsoid. There are three options: No parameter, Bursa Parameters and Molodensky Badekas Parameters.

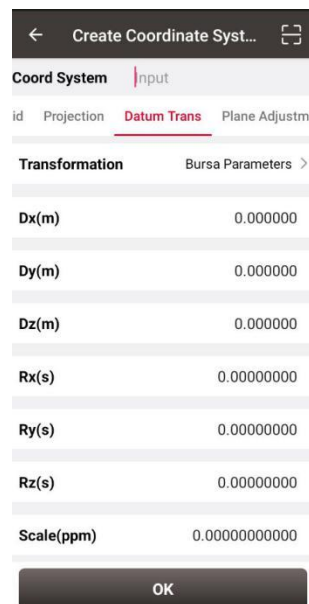

Figure 2.17 Bursa Parameters

[Bursa Parameter]: Axis shift, rotation and scale would be introduced in the datum transformation. Bursa-Wolf seven-parameter model is used from local coordinate to WGS84 system. At least three known points are necessary for accurate transformation. Only X/Y/Z shifts are required only if three parameter transformation is needed.

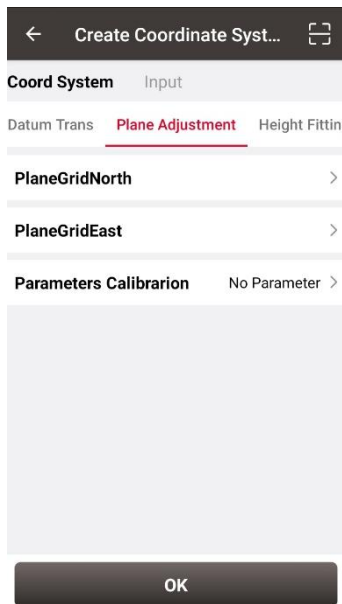

Figure 2.18 Plane adjustment interface

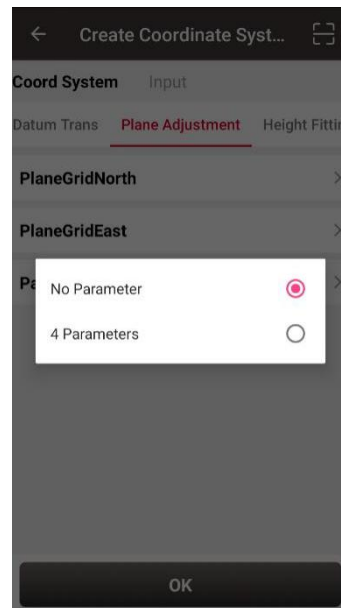

Figure 2.19 Plane adjustment options

[Plane Adjustment]: Plane adjustment is for the transformation between two planes. There are two options for parameters calibration: No parameter and 4 parameters. The detailed information and usage of plane grid refer to section 2.2.5.

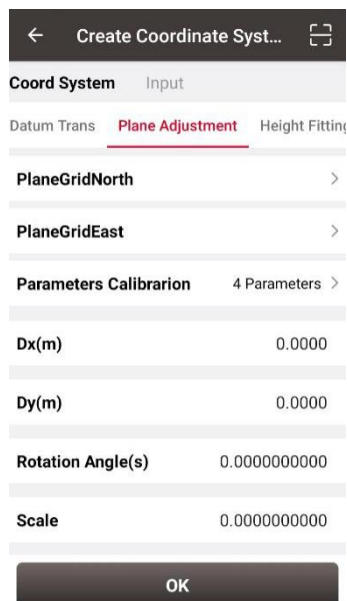

Figure 2.20 4 Parameters

[4 Parameters]: X/Y axis shift, rotation angle and scale are necessary to be input as above. These parameters can be calculated from point correction, details refer to section 4.5.1.

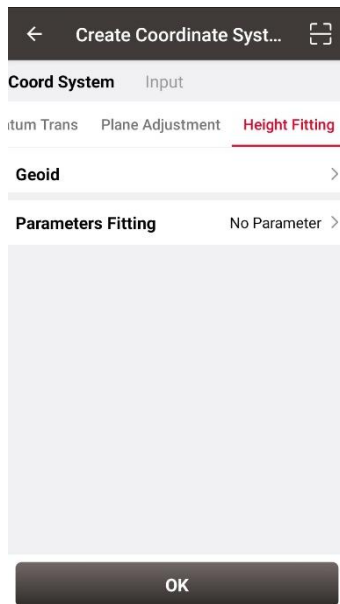

Figure 2.21 Height fitting interface

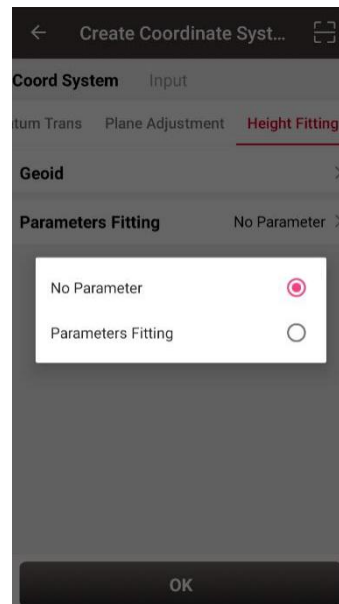

Figure 2.22 Parameters fitting options

[Height Fitting]: Height fitting has two options: Geoid and Parameters Fitting. Parameters fitting includes no parameter and detailed parameters fitting.

[Geoid]: Geoid supports ggf, grd, gsf, osgb and mnt format files, the detailed information and usage of geoid files refer to section 2.2.5.

[Parameters Fitting]: currently three algorithms are supported: fixed difference correction, plane fitting and surface fitting. The parameters needed can be calculated from point correction, details refer to section 4.5.2.

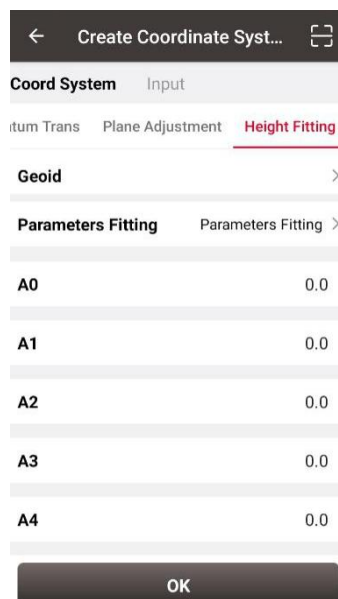



Figure 2.23 Height Fitting – Parameters Fitting

After setting all parameters to create a new coordinate system, click [OK] to complete the

configuration.

Click the scan icon  in the top right corner of Figure 2.12, open the camera to scan other surveyor's coordinate system parameters QR code to copy information for creating a new CRS.

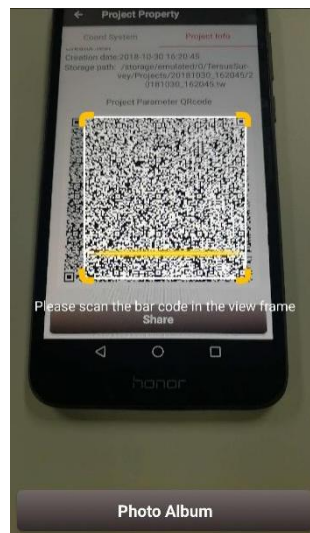

Figure 2.24 Scan QR code to get CRS info

The following shows detailed steps:

- 1) The copied surveyor opens in turn: [Project] -> [Current Project] -> [Project Information], then displays the complete QR code;
- 2) The current surveyor opens the camera when creating new CRS to scan the QR code displayed as shown in Figure 2.24 above and can copy its coordinate system parameters. The QR code screenshot in photo album can also be scanned to obtain the CRS parameters.

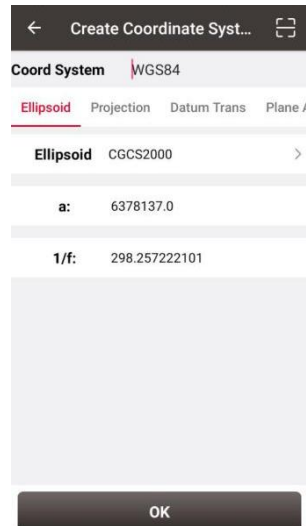

Figure 2.25 CRS info obtained by scanning QR code

3) The coordinate system parameters are obtained as shown in the figure above.

2.2.2 Import CRS

Click [Import] on the bottom left of CRS interface which is shown in Figure 2.11, it shows predefined coordinate systems for users to choose.

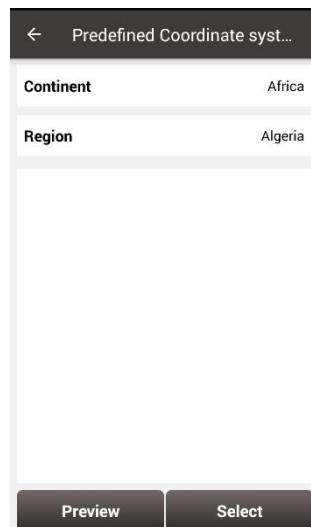

Figure 2.26 Predefined CRS

In the figure above, the predefined coordinate systems are classified by continent and region.

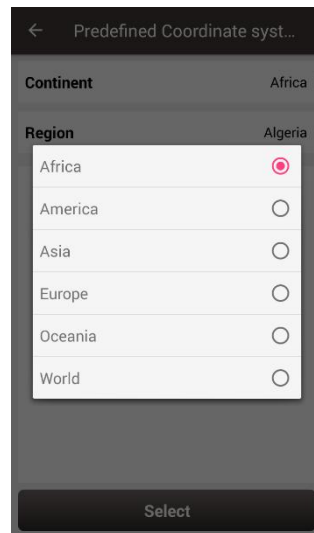

Figure 2.27 Continent options

The continent option includes Africa, America, Asia, Europe, Oceania and World as shown in the figure above. Select a continent, a country or a region, then select a CRS and click [Preview].

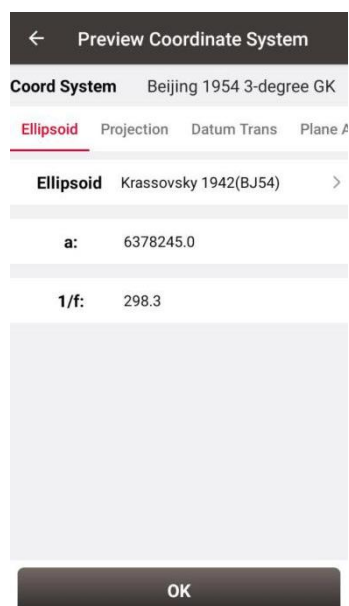

Figure 2.28 Preview of predefined CRS

The above figure is a preview of 'Beijing 1954 3-degree GK CM 075E' coordinate system. Click [OK] and [Select] this CRS, the CRS file is imported to Coordinate System List as shown in the figure below.

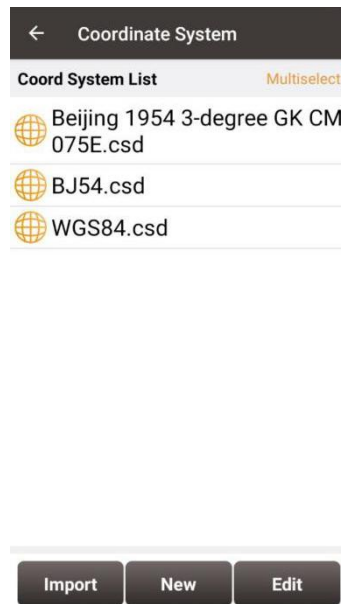

Figure 2.29 Example of CRS import

If the user cannot find the coordinate system of their country or region, but has ellipsoid, projection, datum transformation and other related parameters, you can create a new coordinate system or contact Tersus technical support and we help you create one.

2.2.3 Edit CRS

Click an existing CRS and click [Edit] to enter the Edit Coordinate System interface, refer to the following screenshot:

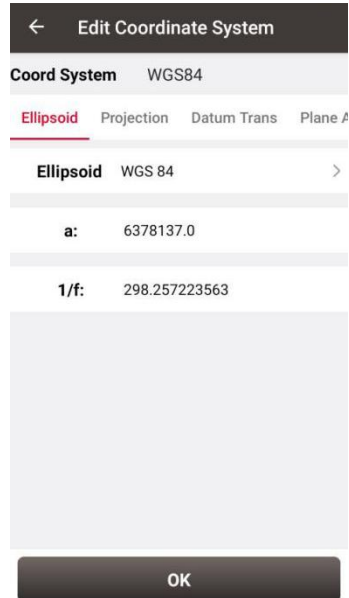

Figure 2.30 Edit Coordinate System

2.2.4 Delete CRS

The default two CRS cannot be deleted. Click [Multiselect] to select the CRS to be deleted and click [Delete] to finish the deletion.

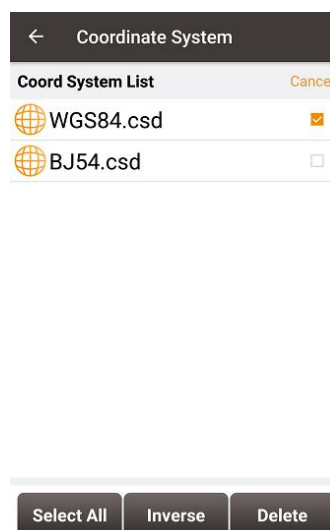

Figure 2.31 Delete CRS

2.2.5 Plane Grid and Geoid

Plane Grid and Geoid are adjustment methods for plane and height, which can improve survey accuracy.

Plane Grid includes plane grid north and plane grid east. Click [PlaneGridNorth] in Figure 2.18 Plane adjustment interface, it enters plane grid north list shown as below. Click [More] to enter download list, the plane grid files can be downloaded from online server. Click [Refresh] to view the current available plane grid files. The plane grid file supports .ggf, .grd, .gsf, and .osgb format. If customer cannot find suitable plane grid file, feel free to contact Tersus support via email support@tersus-gnss.com.

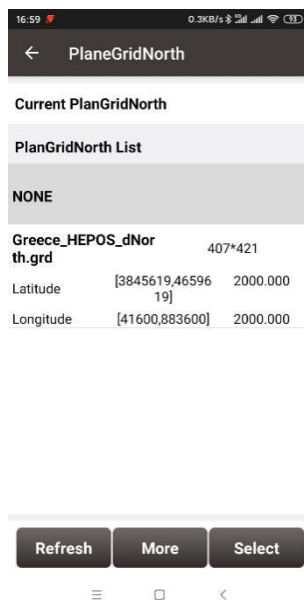

Figure 2.32 Plane Grid list

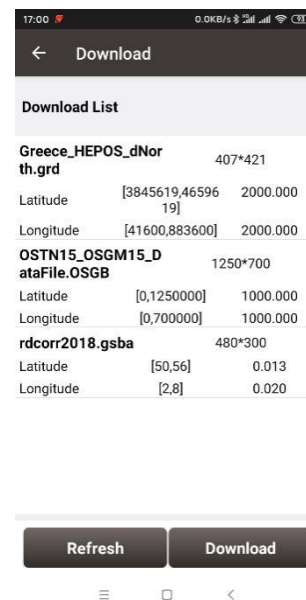

Figure 2.33 Plane Grid download list

After downloading a required plane grid file, select it in the plane grid list and it returns to the plane adjustment interface.

Setting the PlaneGridEast is the same with the above method of setting PlaneGridNorth.

Geoid supports ggf, grd, gsf, osgb and mnt format files, it optimizes data loading, reduces waiting time for different devices, simplifies algorithm calculation process and saves system resources. In a CRS setting, click [Geoid] under Height Fitting tab enter Geoid list which is shown as below. The list shows the coverage latitude, longitude and resolution of

the corresponding geoid model. Click [More] to enter download list, the geoid files can be downloaded from online server.



Figure 2.34 Geoid list



Figure 2.35 Geoid download list

Click [Refresh] to view the current available geoid files. Contact Tersus Technical Support support@tersus-gnss.com to inquire more if customer cannot find suitable Geoid files. After downloading a required geoid file, select it in the geoid list and it returns to the height fitting interface.

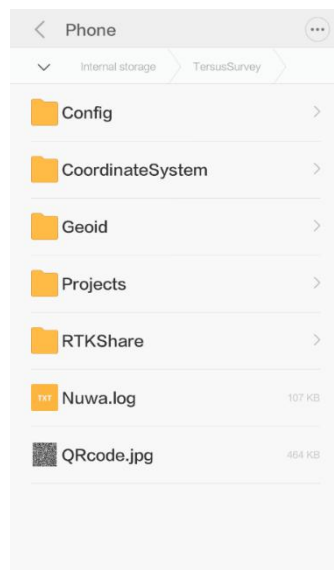

Figure 2.36 Explore Geoid folder in the android device

Another method of importing geoid files: manually copy and paste the Geoid files under the Geoid folder of TersusSurvey as shown above, back to the Geoid list interface and click [Refresh] to view the available Geoid list as shown below.

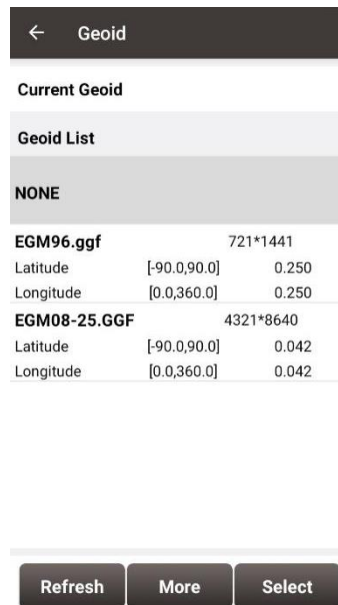

Figure 2.37 Refresh to view the Geoid list

Select one suitable Geoid model and click [Select] to complete the Geoid configuration, and it returns to the height fitting interface.

2.3 Parameters

Seven Parameter and Three Parameter methods are introduced in this section.

Seven Parameter: this method can cover long distance range, generally more than 50 km. At least three known points are required in local datum and in WGS84 system before calculating.

Three Parameter: at least one known point is required. This method can cover short distance range; the accuracy is determined by working area and decreased with the distance.

The following is an example of Seven Parameter. Click [Project] -> [Parameters] to enter the following interface.

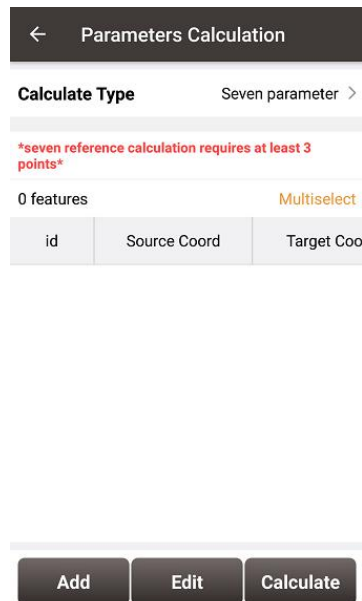

Figure 2.38 Parameters Calculation

Select seven parameter for Calculate Type, click [Add] on the bottom left to input the known points.

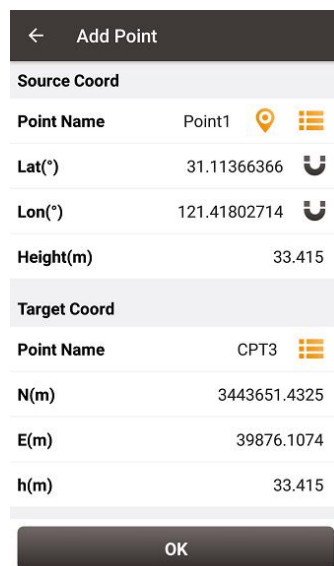

Figure 2.39 Add Point for calculation

For the Source Coordinate, input Latitude, Longitude and Height by manual input, collected from a Tersus receiver or selected from the survey point list. For the Target Coordinate, input the local values from manual input or selected from the control point list.

- Manual input

Input the point position according to the format required. The latitude/longitude format can be changed by clicking the icon on the right.

- Point library

Click [📍] to load points from point library. Points can be added by clicking [Add] in the Point interface.

- Smooth Acquisition

Click [📍] to start smooth acquisition through Tersus receiver.

After points are added, click [Calculate] on the bottom right to do the parameter transformation. The result is shown as below screenshot:

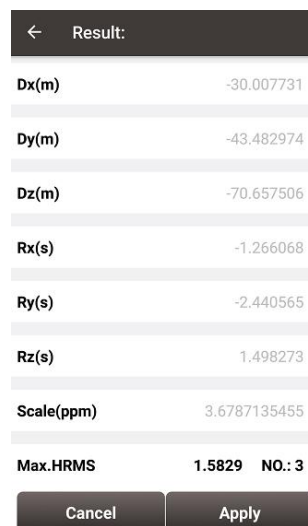

← Result:	
Dx(m)	-30.007731
Dy(m)	-43.482974
Dz(m)	-70.657506
Rx(s)	-1.266068
Ry(s)	-2.440565
Rz(s)	1.498273
Scale(ppm)	3.6787135455
Max.HRMS	1.5829 NO.: 3
<div style="display: flex; justify-content: space-around;"> Cancel Apply </div>	

Figure 2.40 Parameters Calculation Result interface

Note: Before this calculation, please make sure that the project parameters (ellipsoid, projection, etc.) are used correctly.

After the calculation is completed, click [Apply] to apply to the datum transformation parameters of the current project coordinate. When Max.HRMS is too large, the software will prompt a notice of whether continue to apply if the value is too large; if you click [Cancel], it will not be applied to the datum transformation parameters.

2.4 Point

Point library includes survey point library, control point library and staking point library.

2.4.1 Survey Point

Click [Project] -> [Point] and see the survey point library as below.

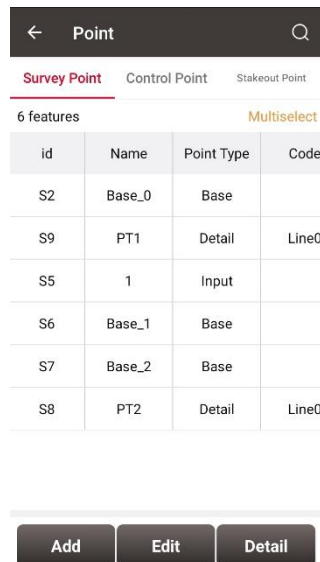

id	Name	Point Type	Code
S2	Base_0	Base	
S9	PT1	Detail	Line0
S5	1	Input	
S6	Base_1	Base	
S7	Base_2	Base	
S8	PT2	Detail	Line0

Figure 2.41 Survey Point Interface

In the survey point library interface, slide in the left or right direction to check the point information, such as coordinates, collection time, and etc.

1) Add survey point

Under the Survey Point interface, click [Add] to enter the Add Point interface.

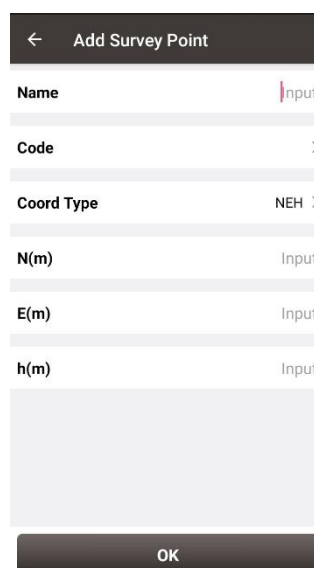
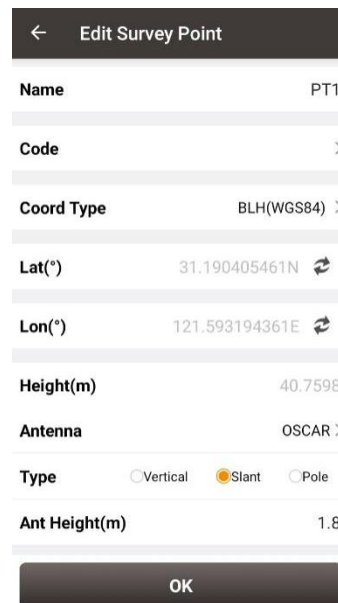

Figure 2.42 Add survey point

Fill in the point name and code, choose the coordinate type (including two types: BLH and NEH), fill in the coordinate values, click [OK] to add a new survey point. The point type of the added survey point is called Input Point.

2) Edit survey point

In the survey point interface, choose a points to be edited, and click [Edit] to enter the Edit interface.



← Edit Survey Point	
Name	PT1
Code	>
Coord Type	BLH(WGS84) >
Lat(°)	31.190405461N ↻
Lon(°)	121.593194361E ↻
Height(m)	40.7598
Antenna	OSCAR >
Type	<input type="radio"/> Vertical <input checked="" type="radio"/> Slant <input type="radio"/> Pole
Ant Height(m)	1.8
OK	

Figure 2.43 Edit survey point

Note: The base point and calculated point cannot be edited; all info of the input point can be edited; only antenna info of the detailed point, continuous point and stake point can be edited.

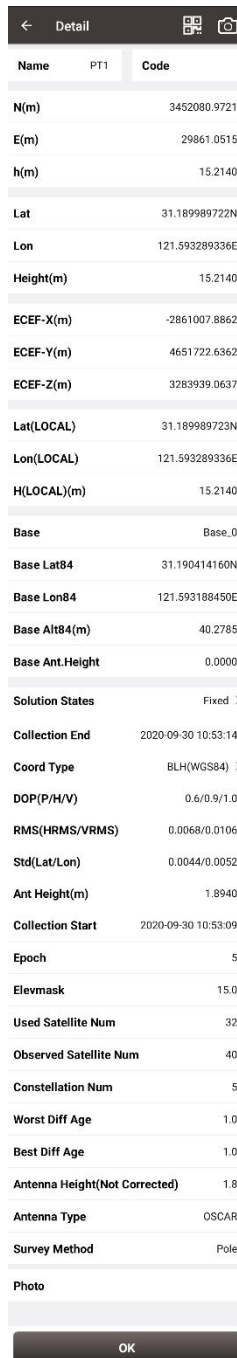

3) View details of survey point

In the survey point interface, choose a point and click [Detail] to view details of this point.





Name	PT1	Code
N(m)		3452080.9721
E(m)		29861.0515
h(m)		15.2140
Lat		31.189989722N
Lon		121.593289336E
Height(m)		15.2140
ECEF-X(m)		-2861007.8862
ECEF-Y(m)		4651722.6362
ECEF-Z(m)		3283939.0637
Lat(LOCAL)		31.189989723N
Lon(LOCAL)		121.593289336E
H(LOCAL)(m)		15.2140
Base		Base_0
Base Lat84		31.190414160N
Base Lon84		121.593188450E
Base Alt84(m)		40.2785
Base Ant.Height		0.0000
Solution States		Fixed >
Collection End		2020-09-30 10:53:14
Coord Type		BLH(WGS84) >
DOP(P/H/V)		0.6/0.9/1.0
RMS(HRMS/VRMS)		0.0068/0.0106
Std(Lat/Lon)		0.0044/0.0052
Ant Height(m)		1.8940
Collection Start		2020-09-30 10:53:09
Epoch		5
Elevmask		15.0
Used Satellite Num		32
Observed Satellite Num		40
Constellation Num		5
Worst Diff Age		1.0
Best Diff Age		1.0
Antenna Height(Not Corrected)		1.8
Antenna Type		OSCAR
Survey Method		Pole
Photo		

Figure 2.44 View details of survey point

On the upper right corner there are two icons: QR code icon  and camera icon .

The detailed descriptions are as below.

- a. Share the point via QR code. Click  icon to generate the QR code of this survey point. This QR codes contains the point name, code and coordinate information separated by a comma. Other surveyor can obtain these information by scanning this QR code.

- b. Photo of the survey point. Click  to take a photo using system camera. The photo will be displayed at the bottom of the point detail for preview. The photo is named with point name plus shooting time. The photos are stored under the folder of TersusSurvey/Projects/ProjectName.

4) Graphic display

In the survey point interface, click the up-right  icon to enter graphic interface.

In graphic interface, zooming, panning and online maps are supported.

In graphic interface, the selection of points is supported. For example, in some tools, click the point selection button and enter the point library, then click the graphic display button and enter the graphic interface, you can click on the point of interest directly on the map to select it.

The control point library and staking point library also have graphic interface.

5) Query survey point

In the survey point interface, click the up-right  icon to enter Point Query interface as below.

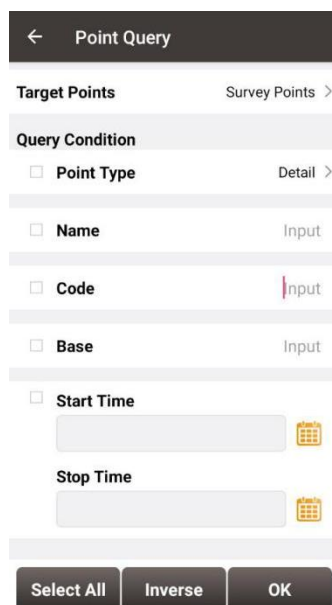

Figure 2.45 Point Query interface

Query condition details are as follows:

[Point Type]: Detail, continuous, input point, calculate or base.

[Name]: Point name to be queried.

[Code]: Code number.

[Base]: The name of the base.

[Start/Stop Time]: Start and stop time of the points

Click [OK] to search all the points meeting the query conditions.

6) Delete survey point

In the survey point interface, click [Multiselect], select the points to be deleted and click [Delete] to complete the deletion.

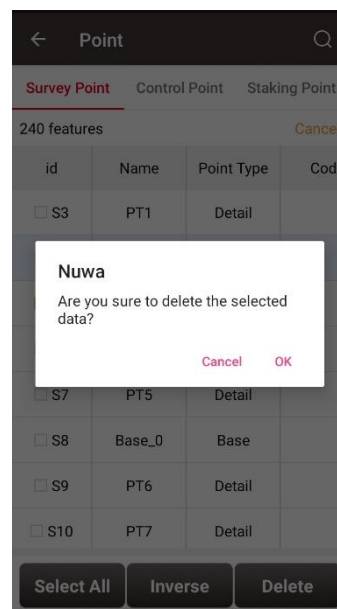
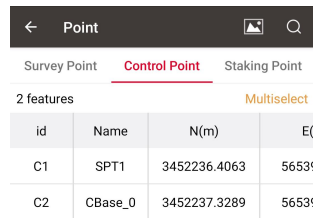

Figure 2.46 Pop-up notice before deletion

Note: The base point in the survey point library cannot be deleted.

2.4.2 Control Point

In Nuwa app, the control points are used in parameter calculation and point correction.



id	Name	N(m)	E(m)
C1	SPT1	3452236.4063	56539
C2	CBase_0	3452237.3289	56539



Figure 2.47 Control Point interface

1) Import control point

In the Control Point interface, click [Import] to import the control points.

It can be done in three ways: From File, From Survey Point and Manually Add.

Select [From File] to enter the import data interface.

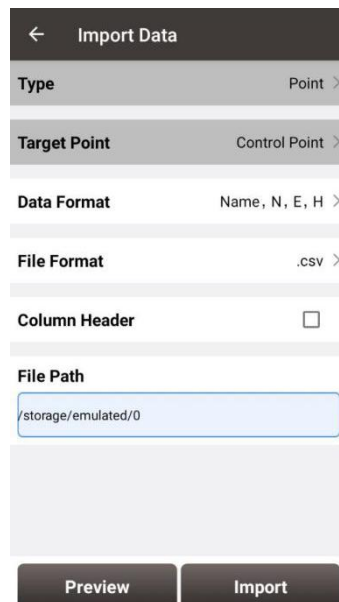

← Import Data

Type Point >

Target Point Control Point >

Data Format Name, N, E, H >

File Format .csv >

Column Header

File Path
/storage/emulated/0

Preview Import

Figure 2.48 Import Data info

Then click [Data format] and select a format in the pop-up list.

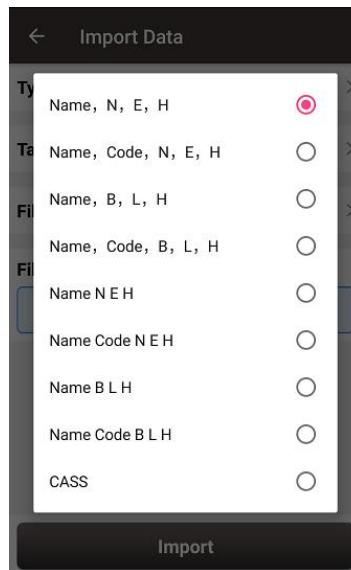

Figure 2.49 Data format list

Select file format and file path to import points. Then click [Import] to import the required points.

Select [From Survey Point] and then select the points in the Survey Point list.

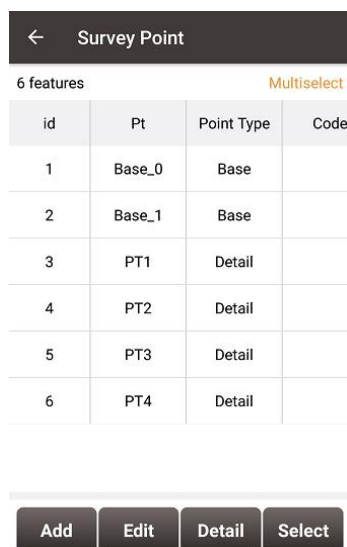

Figure 2.50 Import Survey Point

Select [Manually Add] to enter the Add Control Point interface.

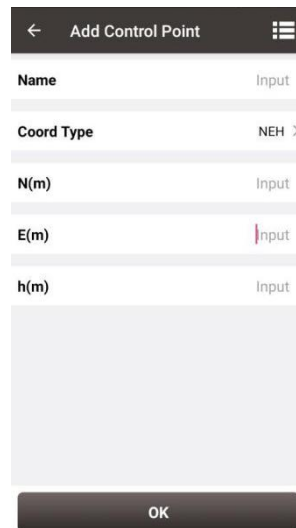



Figure 2.51 Add Control Point

Choose the coordinate type (including two types: BLH and NEH), fill in the point name and the coordinate values, or click the upper right  icon to import the survey point directly.

2) Edit control point

In the control point interface, select a control point, click [Edit] to edit control point.

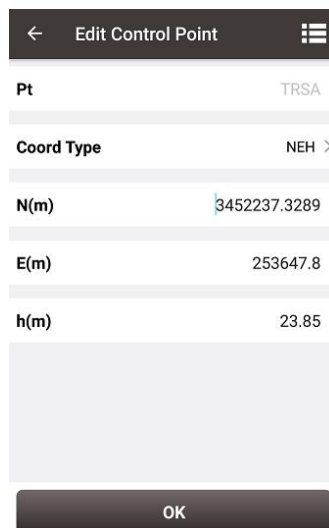

Figure 2.52 Edit Control Point interface

3) Query control point

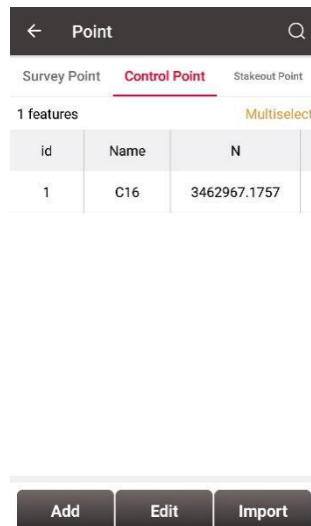



Figure 2.53 Control Point interface

Click the up-right  icon to enter Control Point Query interface. The query conditions include name, code and start/stop time.

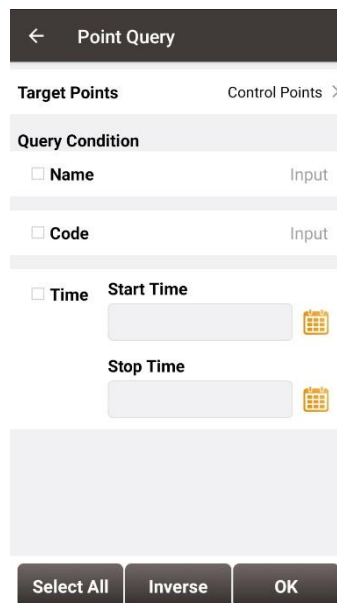

Figure 2.54 Point Query interface

4) Delete control point

Click [Multiselect] in the control point interface to enter the following interface. Select the points to be deleted and click [Delete] to complete the deletion.

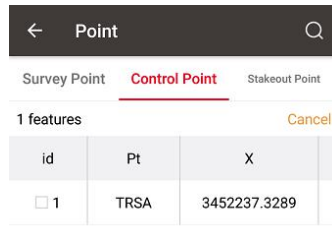

Figure 2.55 Delete control point

2.4.3 Staking Point

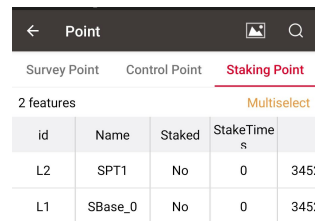

Figure 2.56 Staking Point interface

1) Import staking point

In the staking point interface, click [Import] to import staking points.

It can be done in four ways: From Files, From Survey Point, From Control Point, Manually Add.

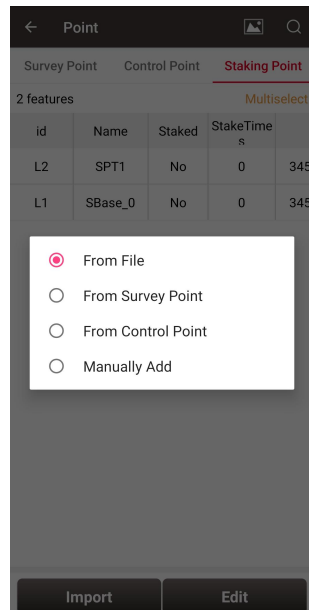

Figure 2.57 Import source for Staking Point

Choosing [From File] leads to the similar steps of importing Control Point.

Choosing [From Survey Point] leads to the figure below. One or more points can be selected and imported as Staking Points.

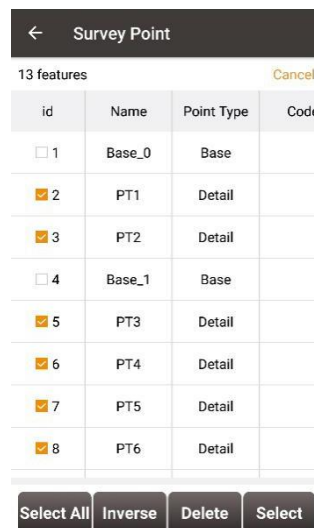
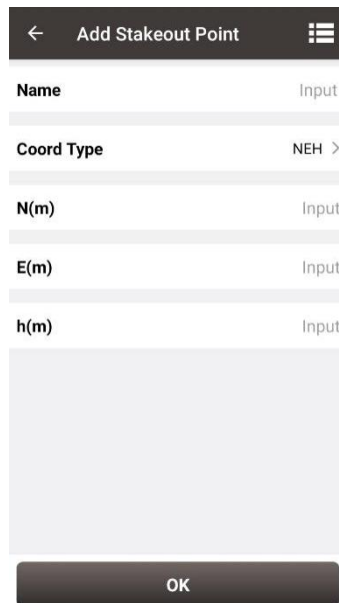

Figure 2.58 Import from Survey Point

Choosing [From Control Point] leads to the control point list. One or more points can be selected and imported as Staking Points.

Choosing [Manually Add] leads to the Add Staking Point interface.



Field	Label
Name	Input
Coord Type	NEH >
N(m)	Input
E(m)	Input
h(m)	Input

Figure 2.59 Control Point interface

2) Edit staking point

In the staking point interface, select a staking point and click [Edit] to enter the editing interface.

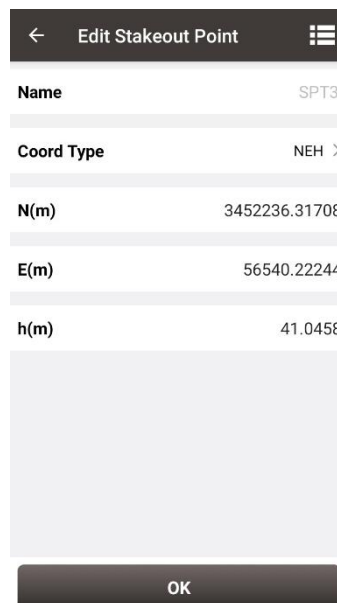

Field	Value
Name	SPT3
Coord Type	NEH >
N(m)	3452236.31708
E(m)	56540.22244
h(m)	41.0458

Figure 2.60 Edit staking point

3) Query staking point

Click the up-right  icon to enter Staking Point Query interface. The query conditions include name, code and start/stop time.

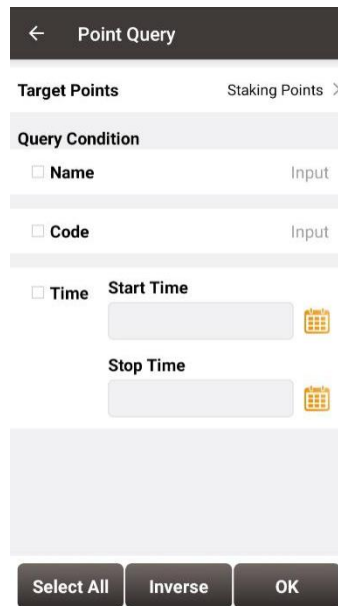

Figure 2.61 Query staking point

4) Delete staking point

Click [Multiselect] in the staking point interface, select the points to be deleted and click [Delete] to complete the deletion.

2.5 Line

This section includes survey line and staking line.

2.5.1 Survey Line

1) Add survey line

Click [Project] - > [Line] and see the Survey Line as below.



Figure 2.62 Line interface

Click [Add] under Survey Line to enter the following interface.

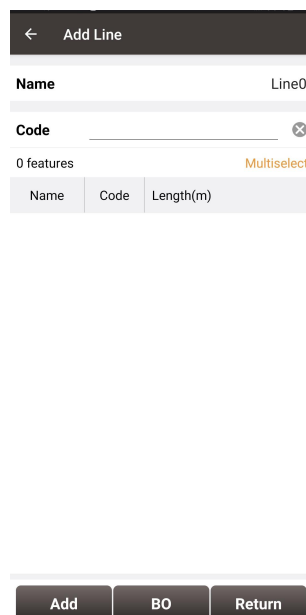

Figure 2.63 Add survey line interface

Fill in a line name or use the default name, input a code for comment purpose, click [Add]

in the bottom left to select two points in the survey point library as below.

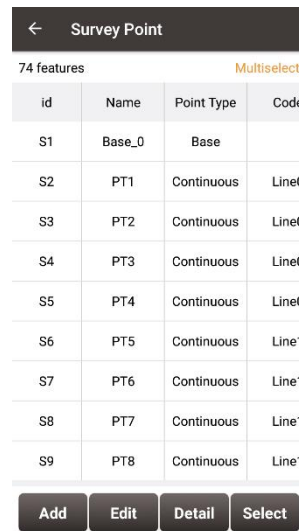

Figure 2.64 Select two points from survey point library – 1

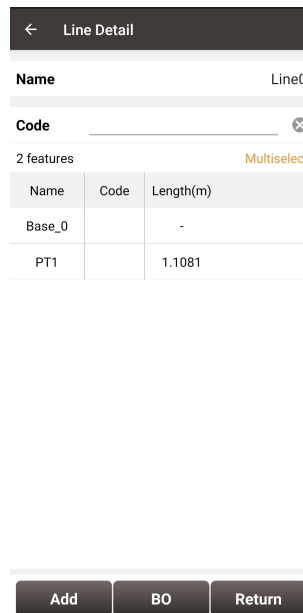
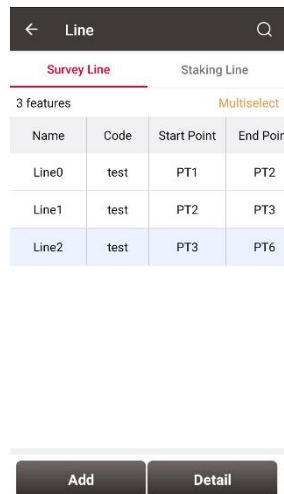

Figure 2.65 Select two points from survey point library – 2

Click [BO] to close the new survey line.

Click [Return] and the new survey line has been added as below.



Survey Line		Staking Line	
3 features Multiselect			
Name	Code	Start Point	End Point
Line0	test	PT1	PT2
Line1	test	PT2	PT3
Line2	test	PT3	PT6

Add Detail

Figure 2.66 Survey line added

The added survey line can be viewed under [Survey] -> [Point Survey] shown as below.

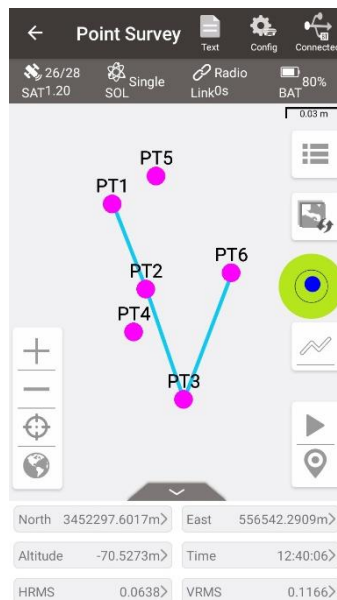

Figure 2.67 Survey line in survey interface

2) View and edit survey line

In the Line interface, select the line to be edited. Then click [Detail] to enter the edit page shown as below.

←
Line Detail

Name Line2

Code test

2 features Multiselect

Name	Code	Length(m)
PT3		-
PT6		0.0719

Add

Return

Figure 2.68 Edit a survey line 2

If not selecting a point, click [Add] to add a point at the end shown as Figure 2.69; if selecting a point, then click [Add] to insert a point before the selected point shown as Figure 2.71. After adding the point, the length will be recalculated, and then enter the survey interface to find that the added point is connected to the line shown as Figure 2.70 and Figure 2.72.

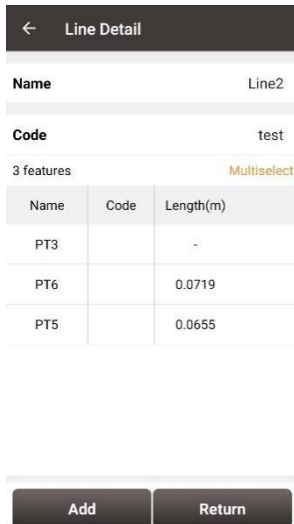

Figure 2.69 Add PT5 to the line end

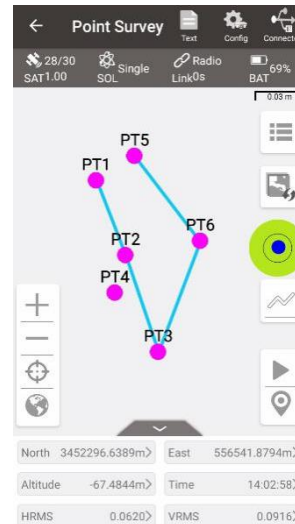

Figure 2.70 The new Line2 in survey interface

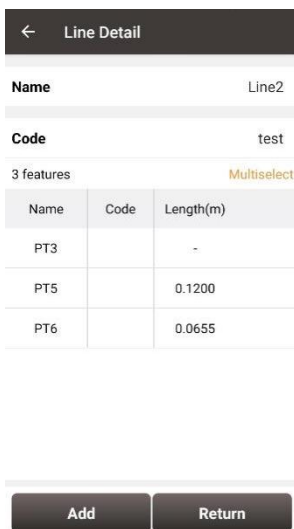

Figure 2.71 Add PT5 before PT6

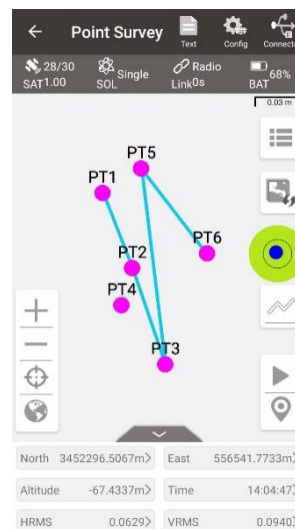

Figure 2.72 The new Line2 in survey interface

Click [BO] to close the survey line.

Click [Multiselect] to select a point and click [Delete]. After the deletion, the length will be recalculated, and then enter the survey interface to find that the deleted point is no longer connected to the line. For example, after deleting PT5 in Line2, this point PT5 is no longer in Line2 shown as below.

Note: After deleting the point in the line, the point and its information will be retained in the point library. It exists as a point, but it is no longer connected to the line.

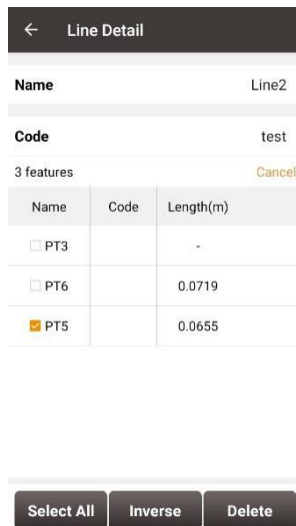

Figure 2.73 Delete PT5 in Line2

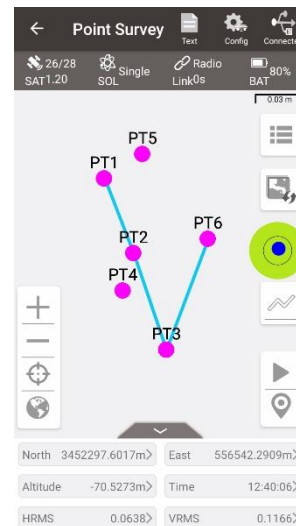

Figure 2.74 Line2 after deleting PT5

3) Query survey line

Click the icon at the up-right corner, the line query interface is shown as below. Input the search items and tick the item, click [OK] to search the line.

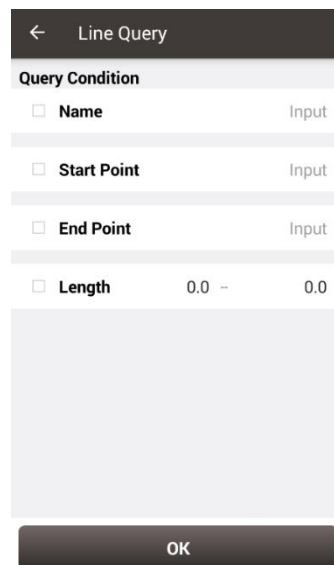

Figure 2.75 Line Query interface

4) Delete survey line

In the Survey Line interface, click [Multiselect] to enter the following interface. Tick the line to be deleted, then click [Delete] to complete deletion.

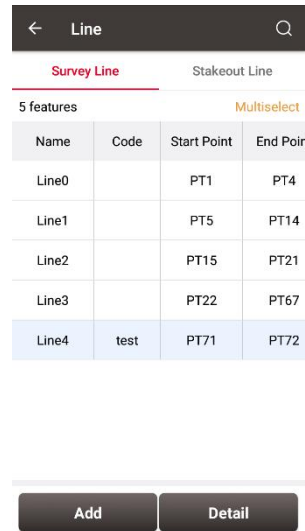

Figure 2.76 Survey line interface

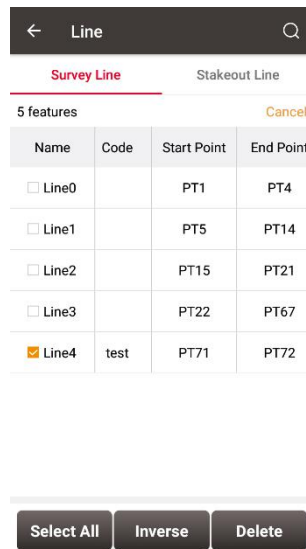

Figure 2.77 Tick the line to be deleted

2.5.2 Staking Line

1) Add staking line

Click [Add] under Stakeout Line to enter the following interface, there are four types of staking line: line, polyline, arc and circle.

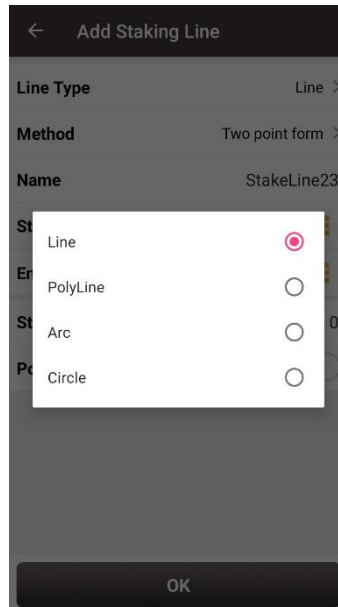

Figure 2.78 Four types of staking line

a. Line

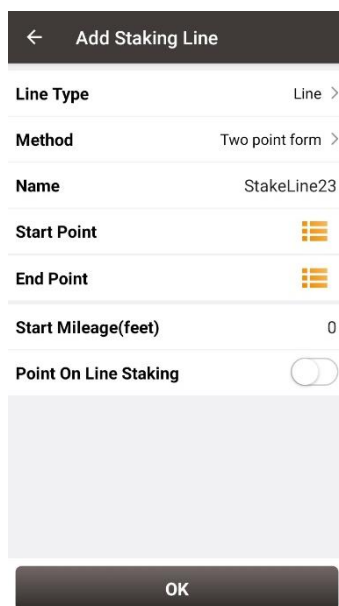

Figure 2.79 Add line method 1

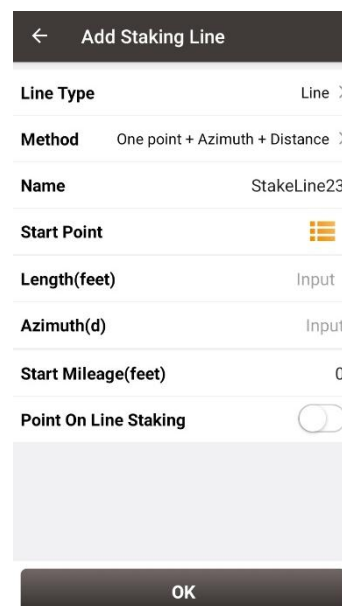



Figure 2.80 Add line method 2

- Two Points:

Input the name of the line, then click  to import the start point and end point.

- One point + Azimuth + Distance

Input the name of the line, then click  to import the start point from a point library.

Input the other information for the line.

Start Mileage: default is 0. The mileage of other points on the line will be obtained by adding the start mileage and the mileage from the starting point.

Point On Line Staking

- Turn on this function, you can set the pile interval and the stakeout will start from the starting point of the staking line to the end point at this interval.
- Turn off this function, the stakeout will be to the vertical cross point between the current position and the staking line (or the extension line).

b. Polyline

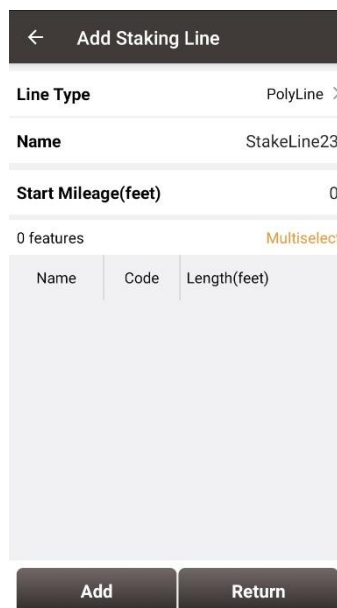

← Add Staking Line

Line Type PolyLine >

Name StakeLine23

Start Mileage(feet) 0

0 features Multiselect

Name	Code	Length(feet)

Add Return

Add the points that form the polyline one by one, and click Return to save the polyline as the staking line.

Start Mileage: default is 0. The mileage of other points on the line will be obtained by adding the start mileage and the mileage from the starting point.

c. Arc

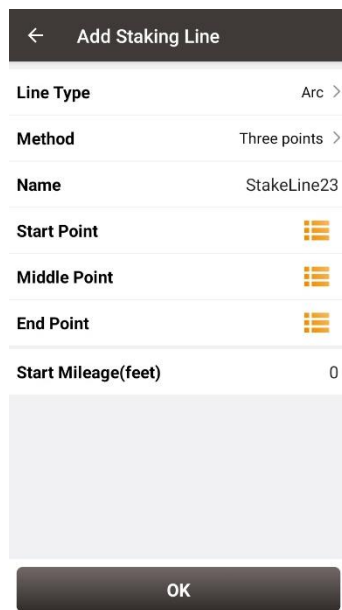

Figure 2.81 Add arc method 1

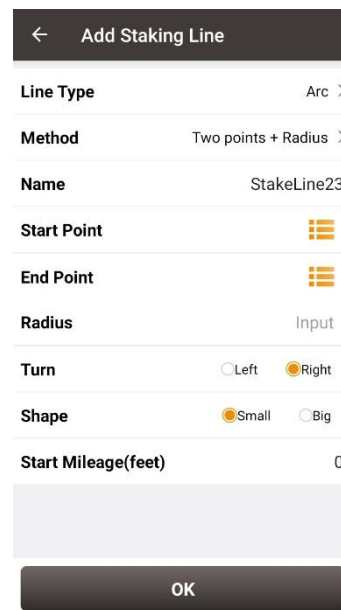

Figure 2.82 Add arc method 2

- Three points: Select the starting point, the middle point and the end point to form the arc.
- Two points + Radius: Select the starting point and end point, enter the radius, select the turning direction and shape of the arc from the starting point to the end point, the software can automatically calculate the center coordinates of the circle to form the arc.

Start Mileage: default is 0. The mileage of other points on the line will be obtained by adding the start mileage and the mileage from the starting point.

d. Circle

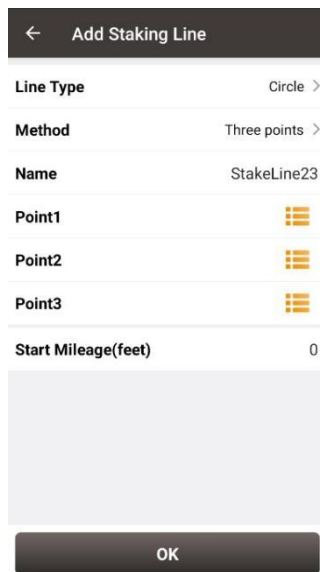

Figure 2.83 Add circle method 1

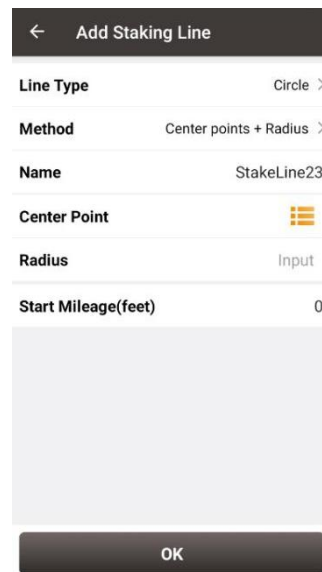

Figure 2.84 Add circle method 2

- Three points: Select three points on the circle to form a circle.
- Center point + Radius: Select the center of the circle and enter the radius to form the circle.

Start Mileage: default is 0. The mileage of other points on the line will be obtained by adding the start mileage and the mileage from the starting point.

2) View and edit staking line

In staking line interface, select a staking line, click [Detail] to enter the edit page and edit the line parameters shown as below.

3) Query staking line

Query of a staking line is the same with query of a survey line, enter the line query interface, input the search items and tick the item, click [OK] to search the staking line.

4) Delete staking line

Deleting a staking line is the same with deleting a survey line, in the staking line interface, click [Multiselect] and tick the staking line to be deleted, click [OK] to

complete the deletion.

2.6 Road

Road management is used to create or edit road data.

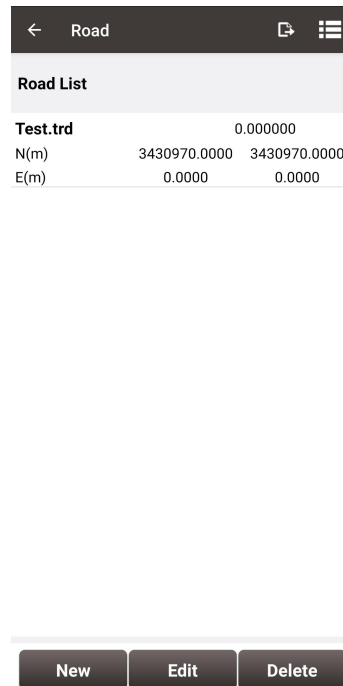

Road List		
Test.trd		0.000000
N(m)	3430970.0000	3430970.0000
E(m)	0.0000	0.0000

Figure 2.85 Road interface

2.6.1 Add new road

The road contains a variety of feature factors. The current software supports the use of intersection method or element method to edit the road's alignment, station equation, vertical profile, cross section, super elevation, and widening.

Alignment

The horizontal alignment is a curve that describes the turning and trend of the road curve in the horizontal plane. It generally consists of straight lines, arcs, and transition curves. The transition curve used in the calculation of the software is the clothoid (also known as Cornu spiral or Euler spiral) commonly used in road design.

Click [Road] -> [New] to enter the Add Road interface shown as below.

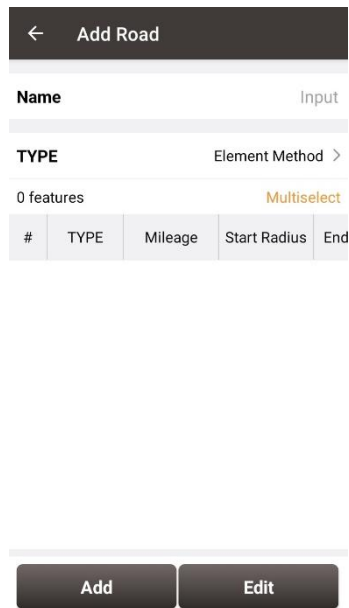

Figure 2.86 Add Road interface

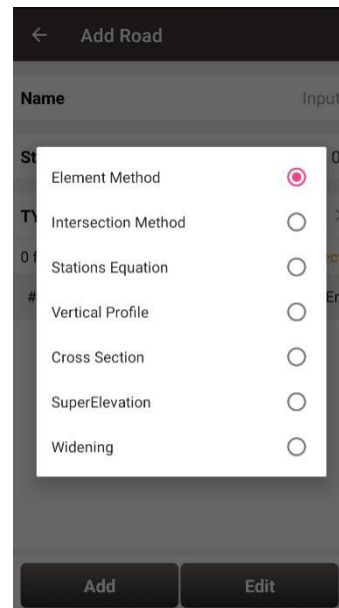

Figure 2.87 Road feature factor options

Intersection method

The intersection method is based on the intersection point in the alignment, and the coordinates are obtained through the intersection point and the route. The general intersection point method to construct an alignment consists of a starting polyline point, N intersection points and an ending polyline point. Enter the coordinates of the designed road at the starting and ending polyline points; the intersection needs to enter the coordinates of the designed intersection point, the length of the entry transition curve, the radius and the length of the exit transition curve. The software will automatically calculate the elements contained under the intersection and draw the road alignment.

The current software supports the conversion calculation from the intersection method to the element method; supports the input of the intersection method of the complete symmetric transition curve and the complete asymmetric transition curve; supports the intersection method input when the transition curve length is 0 or the arc length is 0; it does not support the input of incomplete transition curve; it does not support the intersection method input of special curve such as a turning curve.

Element method

The element method is a method to calculate the alignment coordinates from the node elements such as the starting point coordinates, azimuth angle, starting point stake

number and ending point stake number of the road. Select the corresponding elements when entering the element method, including straight lines, left-turning arcs, right-turning arcs, left-turning transition curves, right-turning transition curves, and then input the corresponding feature parameters of the elements, such as the length, start radius and end radius of the transition curve. The software will draw a road alignment according to the input line elements.

Station equation

A station equation refers to the phenomenon that the stake number is not continued due to stationing changes or section measurement.

Vertical profile

A vertical profile refers to the curve that connects two adjacent wavebands on the vertical section of the line with the slope point as the intersection point. The vertical profile describes the change of the elevation coordinate of the middle stake point. The vertical profile in the software is calculated using a parabola.

Cross section

The cross section refers to the section perpendicular to the center line of the road at the center pile. The main components include motor vehicle lanes, non-motor vehicle lanes, sidewalks, hard shoulders, soil shoulders, central separation belts, and side partitions. The super-elevation and widening properties in the software need to be established on the basis of the standard cross section.

Superelevation

When a vehicle is driving on a curve, it will slip due to lateral force or centrifugal force. In order to offset the centrifugal force generated by the vehicle driving on the curve and ensure that the vehicle passes the curve safely and stably, a unidirectional cross-slope that is higher on the outside than the inside will be set on the cross section of the curved road section, which is the super-elevation property of the road. The superelevation of the road in the software is based on the standard cross-section, which will be reflected in the changes in the slope of the plates composed of different cross-sections, and will ultimately affect the change of the elevation coordinates of the side piles.

Widening

When the vehicle is driving on a curve, the driving trajectory of each wheel is different. The radius of the driving trajectory of the rear wheel on the inner side of the curve is the smallest, and the radius of the driving trajectory of the front wheel near the outer side of the curve is the largest. This phenomenon is more prominent when the radius of the driving curve is small. In order to ensure that the car does not encroach on the adjacent lanes when turning, the curved road sections need to be widened. The widening of the road in the software will be based on the standard cross-section, which will be reflected in the changes in the width of the plates composed of different cross-sections, and will ultimately affect the change of the side pile coordinates.

2.6.2 Edit road

In the road interface, choose a road file and click [Edit] to make edition of the existing road.



Figure 2.88 Road interface

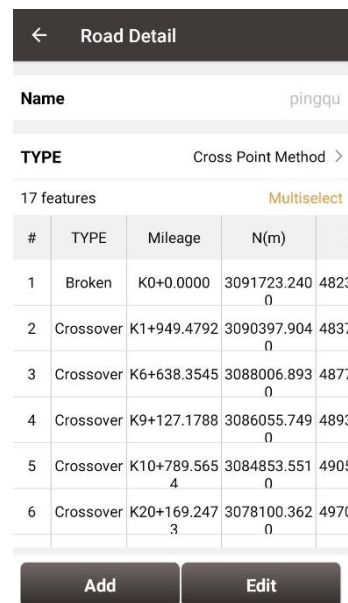

Figure 2.89 Edit an existing road

If the road alignment is created by the intersection method, then it is to edit using the intersection method by default; if the road alignment is created by the element method, then it is to edit using the element method by default. If the road is created by the intersection method, after using the software to switch to the element method, click [Edit], then the software will pop up a prompt asking whether to change from the intersection

method to the element method. This mode modification is irreversible.

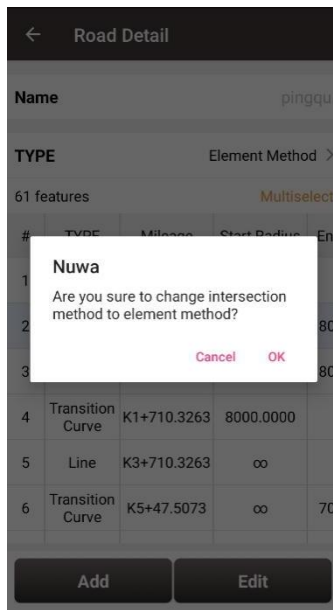



Figure 2.90 Change method when editing road

2.6.3 Delete road

Choose a road file in the road interface, click [Delete] to delete this existing road.

2.6.4 Import/Export road

Tersus road files are in .trd format and stored in the TersusSurvey\Road folder. If a road is created on the Nuwa software of another controller, you can copy the .trd file to this path and open the Nuwa software to load the road.

In the Road interface, select the road, click the icon  , set the storage path to export the cross-section survey data to the designated folder.

In the Road interface, select the road, click the icon  , set the interval to check the road, and set the storage path, and click [Export] to export the road data list to the designated folder.

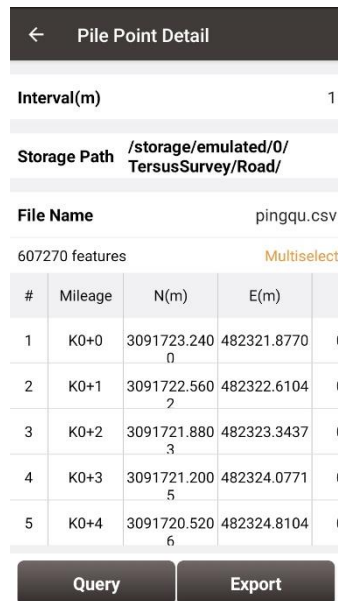

Figure 2.91 Export road file

2.7 Import

There are two types of import: Coordinate Import and Other Import. Coordinate import is to import files with .csv and .dat format. Other Import is to import files with .dxf, .shp and .sima format.

2.7.1 Coordinate Import

Under the Coordinate Import interface, select Type, Target Point library to be added, Data Format, File Format and the file path where the file is located, click [Import] to complete the import.

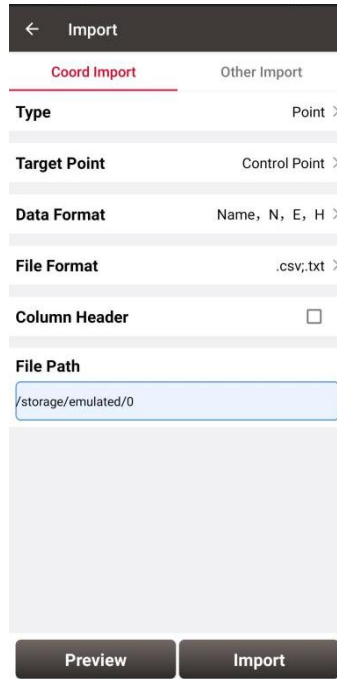

Figure 2.92 Import interface

The figure above shows the parameters that should be selected or filled for coordinate import.

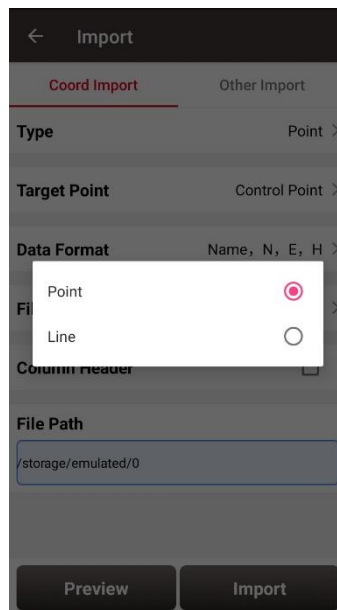

Figure 2.93 Import Type

For point import, select [Point] for Type as shown above.

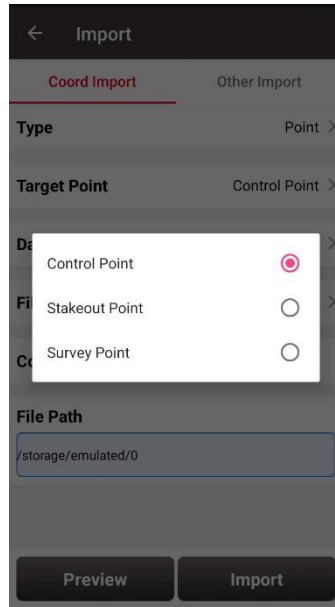

Figure 2.94 Target Point Library

The target point library has three options: control point, stakeout point and survey point as shown above.

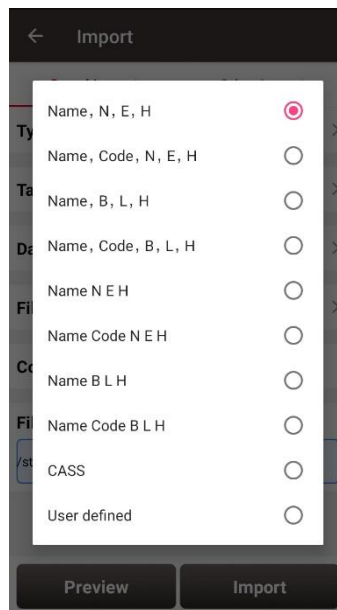

Figure 2.95 Data Format options

The data format options for data import are listed in the figure above.

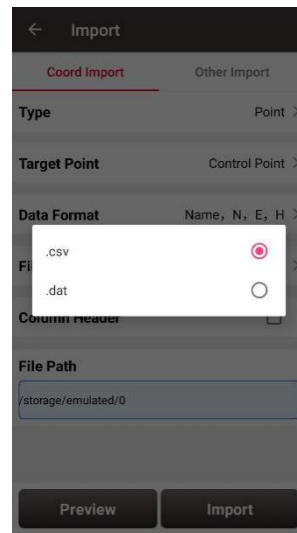

Figure 2.96 File Format options

There are two options for file format of imported points: .csv and .dat files.

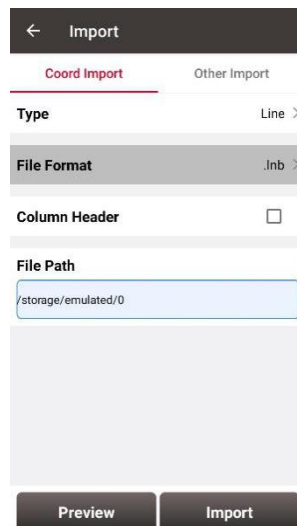

Figure 2.97 Import Line interface

For line import, select [Line] for Type in Figure 2.90 and it goes to the import line interface as shown in Figure 2.94 above. The file format for line is .lnb file.

The line file is a text file with the .lnb extension in nature. The detailed content in the text file is shown as below. The information from left to right is: starting point name, starting point N, starting point E, starting point h, 0, ending point name, ending point N, ending point E, ending point h, 0, 0.

```

5K+250-1,3453407.198,496492.9505,0,0,5K+250-2,3453312.565,496460.4625,0,0,0
5K+300-1,3453388.743,496542.6277,0,0,5K+300-2,3453300.967,496507.4977,0,0,0
5K+350-1,3453368.497,496589.9064,0,0,5K+350-2,3453277.249,496550.8326,0,0,0
    
```

Figure 2.98 Example content in the .Inb file

2.7.2 Other Import

Under the Other Import interface, select the file format, target point and the file path, click [Import] to import the file.

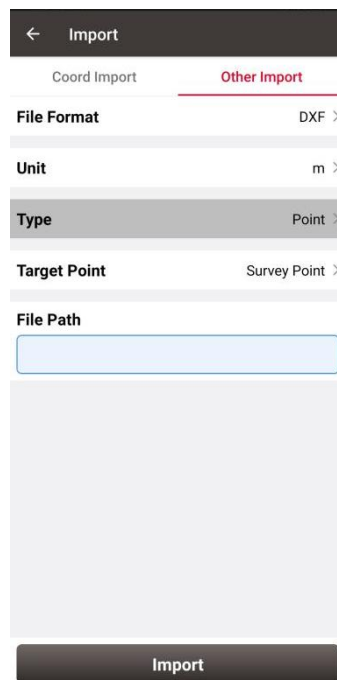

Figure 2.99 Other Import interface

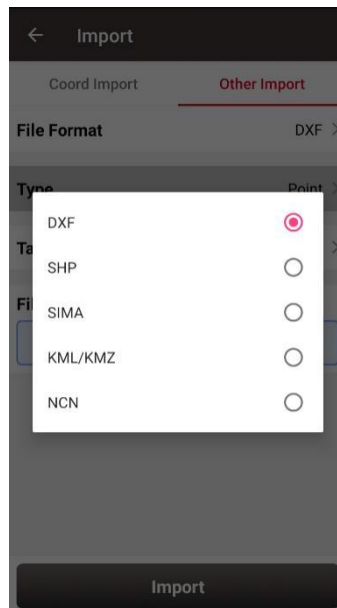

Figure 2.100 File format for other import

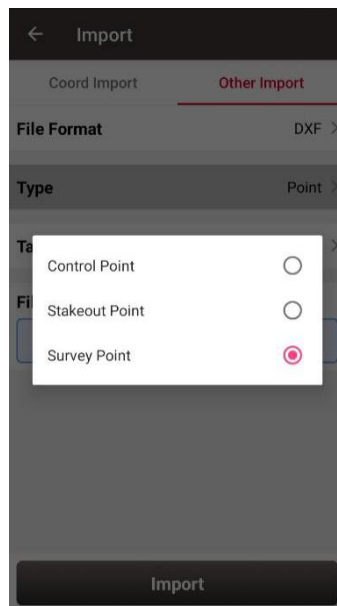

Figure 2.101 Target point options

2.8 Export

Correspondingly there are two types of export: Coordinate Export and Other Export. Coordinate Export is to export .csv files whose file name extension can be modified as .dat; Other Export is to export files with .kml, .shp, .dxf, .html, .xml and .sima format.

2.8.1 Coordinate Export

Under the Coordinate Export interface, select Point Type, Date range and Data Format, ensure the File Name and Storage Path is correct.

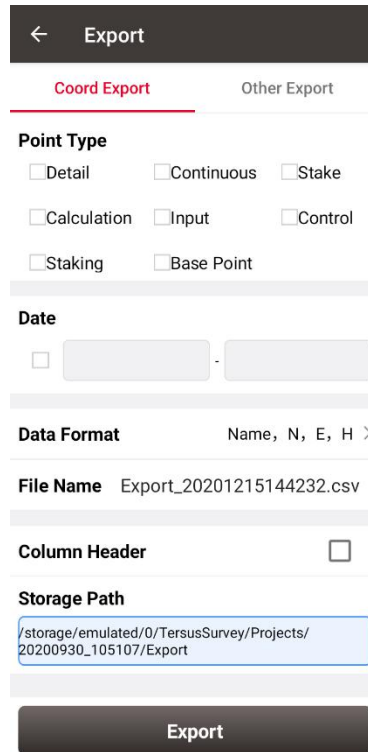

Figure 2.102 Export Interface

Thereafter click [Export] to complete the export.

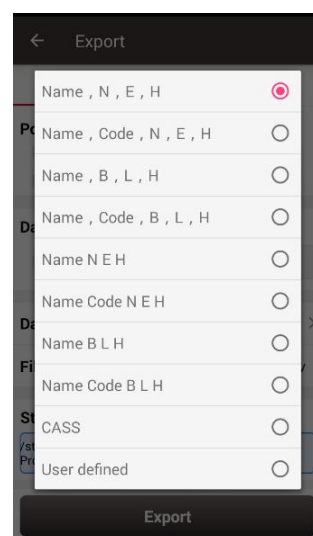

Figure 2.103 Data Format options

For Data Format, the user-defined format can be created or managed. Click [User defined]

and it prompts out an option for data format: create data format and manage data format which are shown as below.

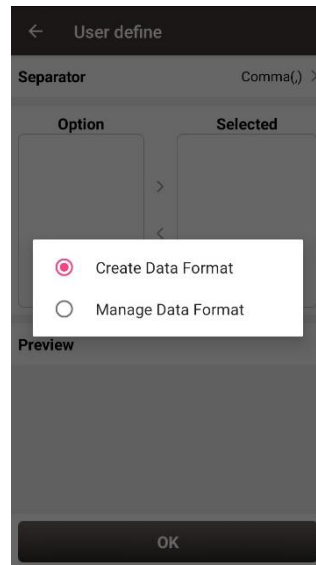

Figure 2.104 User defined data

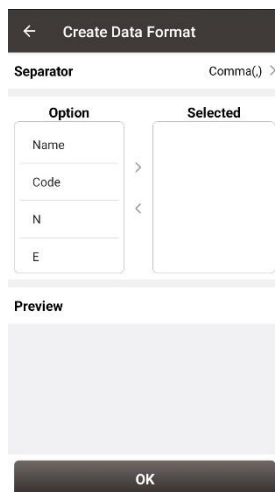

Figure 2.105 Create data format

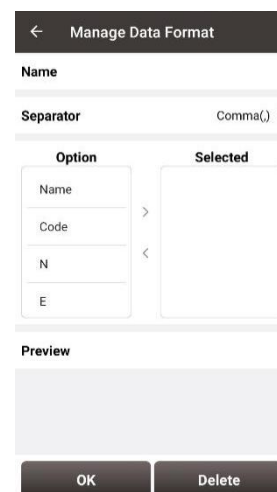

Figure 2.106 Manage data format

2.8.2 Other Export

Under the Other Export interface, file format can be KML, SHP, DXF, HTML, XML, SIMA, KMZ or NCN. Type in the export file name and click [Export] to complete the file export. Please be noted that KML file is the BLH coordinate under the WGS84 coordinate system, SHP / DXF file is the NEH format coordinate under the local coordinate system, HTML file

contains task information, coordinate reference system and survey points, XML file supports EZSurv import.

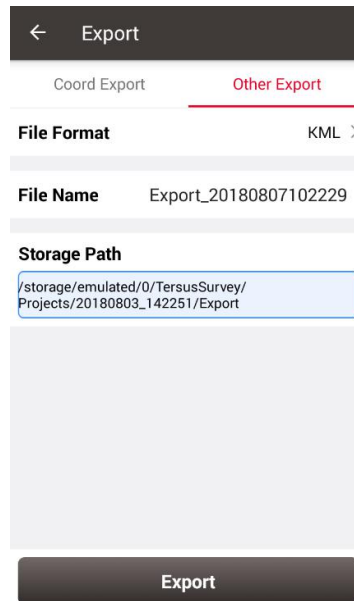

Figure 2.107 Other Export interface

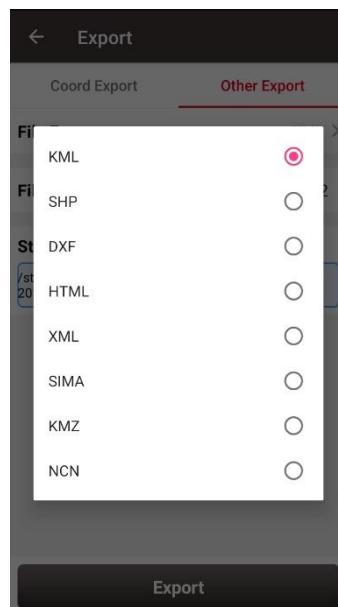

Figure 2.108 File Format for other export

If selecting XML for the file format, select start date and stop date of the Stop&Go survey to ensure the XML file recorded the correct stop points during the Stop&Go survey work.

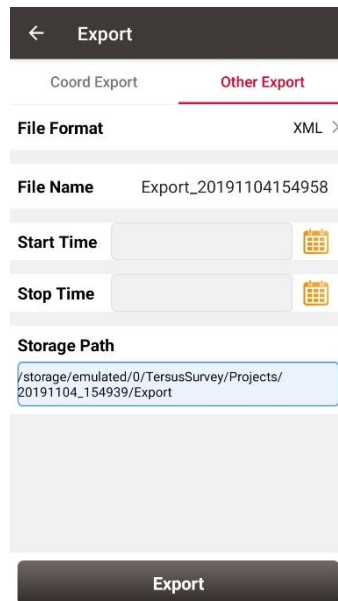

Figure 2.109 Export XML file

Copy the XML file to a computer and open this XML file using a text reader software. Change the rover observation file name on the fifth row to the rover Rinex file name which is shown as below.

```

<?xml version="1.0" encoding="UTF-8"?>
- <GNSSProject xmlns:xsd="http://www.w3.org/2001/XMLSchema"
  xmlns:xsi="http://www.w3.org/2001/XMLSchema-instance">
  <Collector Version="" Name="TERSUS"/>
  <Rovers>
  - <Rover ObsFile="xxx.190">
    <Antenna Model="" Height="1.8180"/>
    <RefTime GPSSecond="443435" GPSWeek="2074"/>
    <Points/>
  - <Sites>
    - <Site Reference="" OnPozId="138" Code="Line10" Id="PT174">
      <Position Height="34.8386" Longitude="121.59318585" Latitude="31.19041192"/>
      <TimeCoverage>
        <StartTime GPSSecond="443435" GPSWeek="2074"/>
        <EndTime GPSSecond="443435" GPSWeek="2074"/>
      </TimeCoverage>
      <StandardDeviation Height="0.0000" Longitude="0.0000" Latitude="0.0000"/>
    </Site>
    - <Site Reference="" OnPozId="138" Code="Line10" Id="PT175">
      <Position Height="34.8386" Longitude="121.59318585" Latitude="31.19041192"/>
      <TimeCoverage>
        <StartTime GPSSecond="443436" GPSWeek="2074"/>
        <EndTime GPSSecond="443436" GPSWeek="2074"/>
      </TimeCoverage>
      <StandardDeviation Height="0.0000" Longitude="0.0000" Latitude="0.0000"/>
    </Site>
    - <Site Reference="" OnPozId="138" Code="Line10" Id="PT176">
      <Position Height="34.8386" Longitude="121.59318585" Latitude="31.19041192"/>
      <TimeCoverage>
        <StartTime GPSSecond="443438" GPSWeek="2074"/>
    
```

change "XXX" to the rover rinex file name

Figure 2.110 Preview of the XML file in text mode

Import the base observation file, rover observation file and the edited XML file to EZSurv application, and EZSurv will identify these files successfully.

2.9 Settings

Settings interface is shown as below, the function descriptions is as follows.

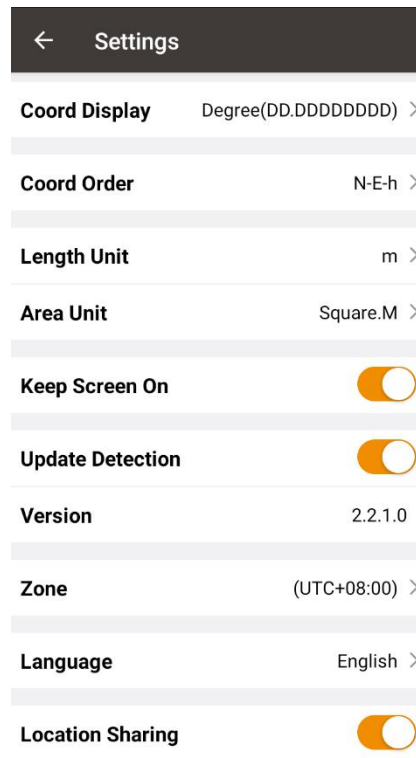

Figure 2.111 Settings interface

[Coord Display]: can be selected from degree (DD.DDDDDDDDD), DM (DD:MM.MMMM) or DMS (DD:MM:SS.SS).

[Coord Order]: the coordinate display order can be NEh or ENh. The display order of north and east coordinates will be displayed in the software according to the selected coordinate type format.

[Length Unit]: can be selected from Km, meter, Inch, Feet or US feet.

[Area Unit]: can be selected from Mu, Square Km, Square Meter, Hectare and Acre.

[Normally On]: the screen would be always on if it is enabled.

[Update Detection]: Auto update detection is on if it is enabled.

[Version]: the current version of the Nuwa app.

[Zone]: select the time zone according to the current position.

[Language]: support Auto, Chinese, English, French, Spanish, German, Portuguese, Italian, Russian, Japanese, Korean, Malay, Arabic, Thai, Turkish, Greek, Bulgarian, and Traditional Chinese.

[Location Sharing]: if it is enabled, it will automatically jump to the android system setting interface. Select Nuwa for the mock location app, the location would be shared with other apps.

When Nuwa app is connected with Oscar GNSS Receiver, you can choose whether to shut down Oscar if you try to exit Nuwa app.

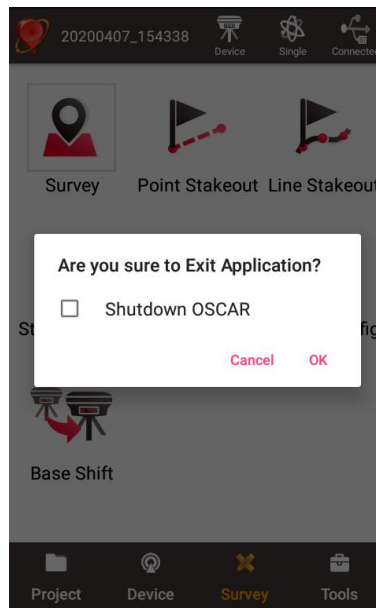

Figure 2.112 Check if shut down Oscar

3. Device

- Connect
- Data Terminal
- Base
- Rover
- NMEA Output
- Device

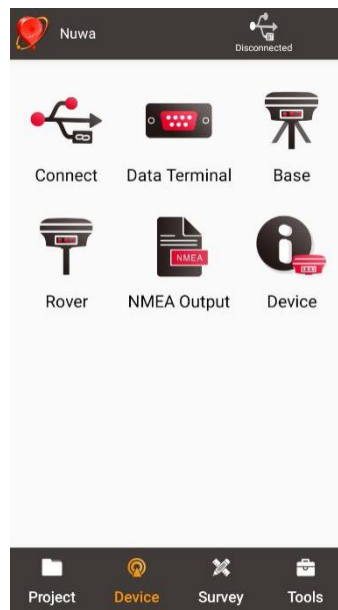



Figure 3.1 Functions under Device

3.1 Connect

There are two ways to enter the Connect interface: Click [Device] -> [Connect] or click  on the up right corner in the status bar. Screenshots and descriptions are as follows.

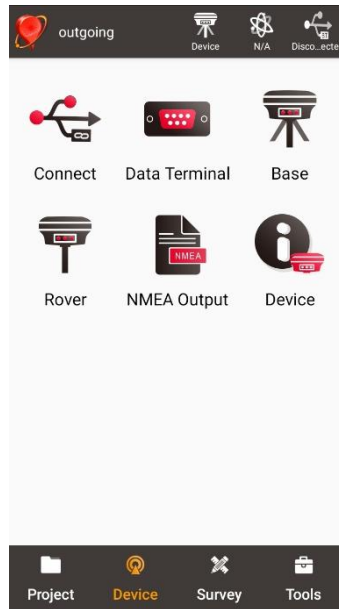

Figure 3.2 Device functional group

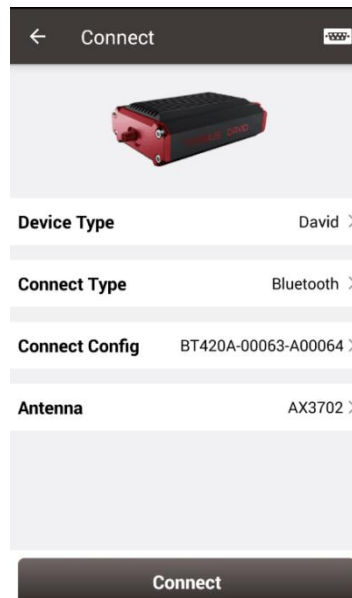

Figure 3.3 Connect interface – David

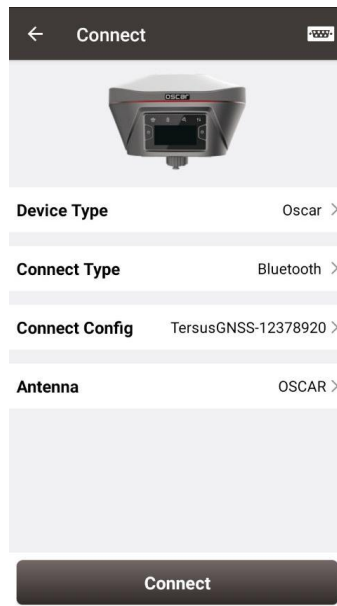

Figure 3.4 Connect interface – Oscar

[Device Type]: can be selected from David, Oscar, NMEA¹ devices, or Simulation.

[Connect Type]: can be selected from USB or Bluetooth.

[Connect Config]: shows the device name to be connected

[Antenna]: can be selected from the antenna list. An antenna with user-defined parameters can be added and selected.

¹Note: NMEA devices should be able to output one of following data: GGA / GSA / GSV / GST / RMC/ RANGEB.

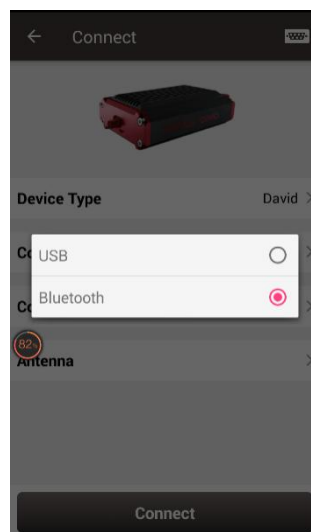

Figure 3.5 Two connection types for David

- USB connection: David can be connected to an android device using a ‘USB Type A Female to USB (Micro+Type C) OTG cable’ in the package. The detailed connection refers to *User Manual for David GNSS Receiver*.
- Bluetooth connection: David can be connected to an android device via wireless method – Bluetooth using ‘COMM1-Bluetooth module’ in the package.
 - 1) Add Bluetooth to the list: select Bluetooth for the [Connect Type], click [Connect Config] and [Search], choose the Bluetooth module to be paired.



Figure 3.6 Bluetooth searching

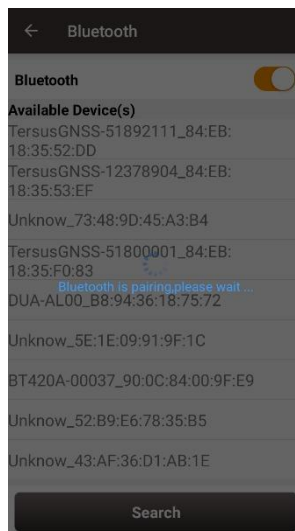

Figure 3.7 Bluetooth is pairing



Figure 3.8 Bluetooth paired

- 2) Remove paired Bluetooth: long press the paired Bluetooth name in the Bluetooth list to remove this paired Bluetooth device in the list.

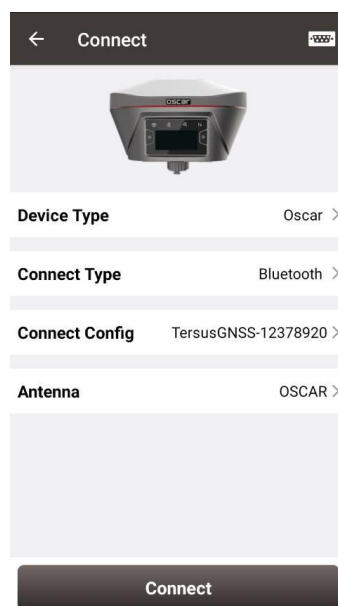

Figure 3.9 Connect interface – Oscar

Currently the connection type for Oscar is Bluetooth only, the other connection types are under development. Stay tuned for the updates. The Bluetooth connection of Oscar is the same with that of David. OSCAR is selected as default antenna for Oscar GNSS Receiver.

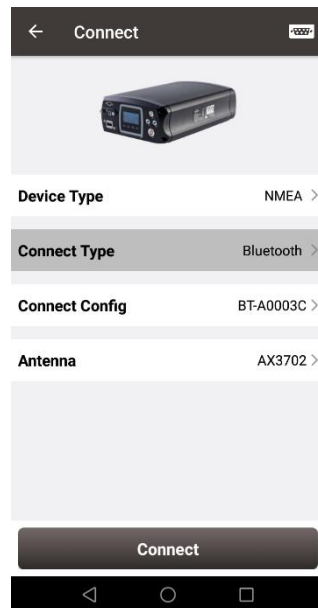
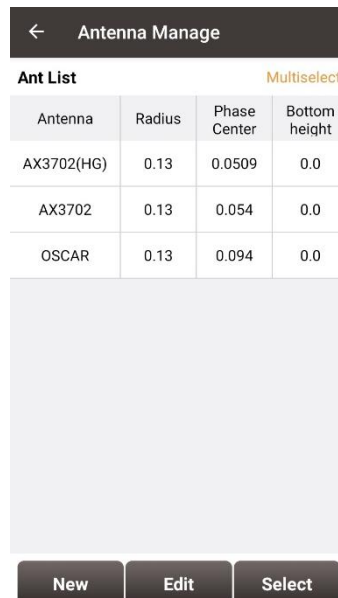

Figure 3.10 Connect interface – NMEA

Currently this connect interface is showing MatrixRTK as an example. In fact, other NMEA devices which support NMEA0183 can also be connected. For NMEA devices, only Bluetooth is used for connect type.

Click [Antenna] to enter the Antenna Manage interface which is shown as below.



Antenna	Radius	Phase Center	Bottom height
AX3702(HG)	0.13	0.0509	0.0
AX3702	0.13	0.054	0.0
OSCAR	0.13	0.094	0.0

Figure 3.11 Antenna Manage interface

Click [New] in the left bottom corner to add new antenna parameters which is shown as below.

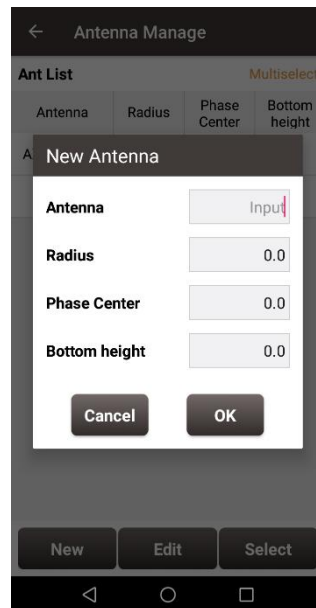

Figure 3.12 Parameters for New Antenna

[Antenna]: input the antenna name for the new antenna.

[Radius]: input the radius of the new antenna when measuring the slant height. Input 0.13 when using the height measure accessory provided by Tersus.

[Phase Center]: input the height from the antenna phase center to the antenna bottom.

[Bottom height]: input the height from the antenna circumference to the antenna bottom.

Note: the unit for the above three parameters is meter (m).

The following figure explains the above three parameters taking AX3702 antenna for example. R: Radius; P: Phase center; B: Bottom height.

Antenna Phase Center

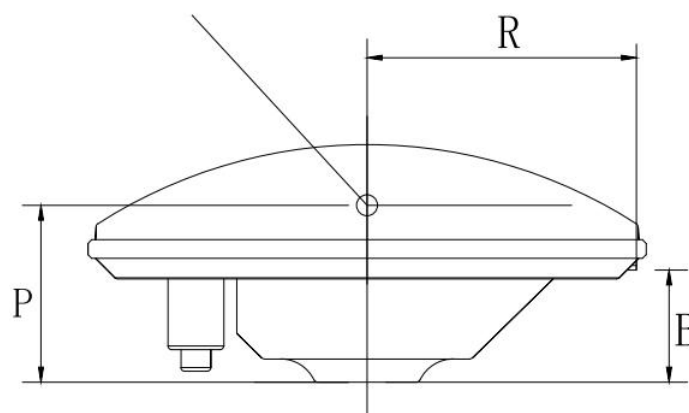

Figure 3.13 Antenna parameters explanation

When selecting Simulation for the device type, the interface is as below.

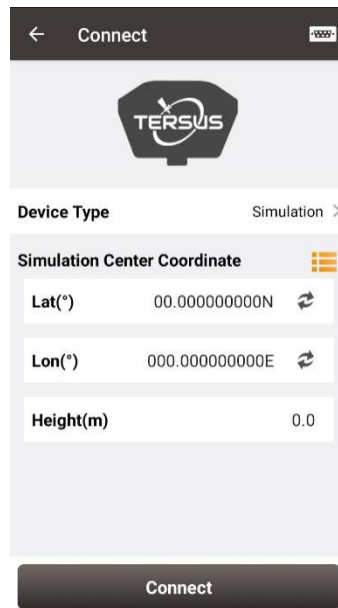

Figure 3.14 Simulation connection interface

The simulation connection be simulated at the place around the coordinates according to the input coordinates or the coordinates selected from the library. The simulation connection can be used for demonstration of survey, stakeout, and etc. However, some functions such as working mode configuration will be restricted.

3.2 Data Terminal

In the data terminal interface, the output loggings can be monitored as shown below. It is outputting ASCII data when David is connected with AX3702 GNSS antenna and it is working normally.

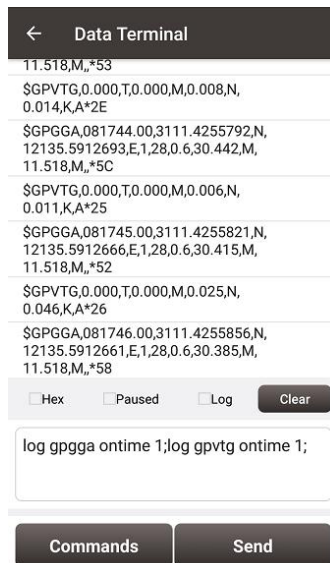

Figure 3.15 Data Terminal interface

Check the box on the left of [Hex] to enable the above window output hex data which is shown below.



Figure 3.16 Data Terminal outputs hex data

Check the box on the left of [Paused] to pause the output logging.

Check the box on the left of [Log] to start recording log data. The log data is saved in a .txt file. Create file name in the pop-up window as shown below.

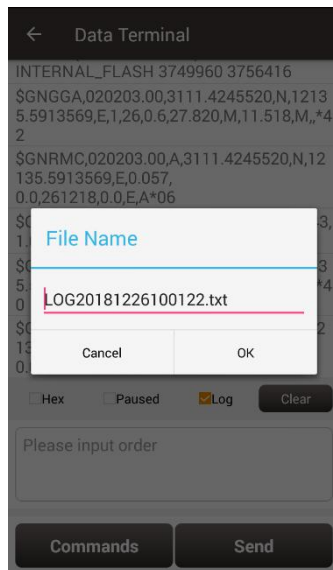

Figure 3.17 Create File Name

Click [OK] to confirm the file name, it automatically starts recording log data and stores the data in the default folder /storage/emulated/0/TersusSurvey/GpsLogger/xxxxxx.txt.

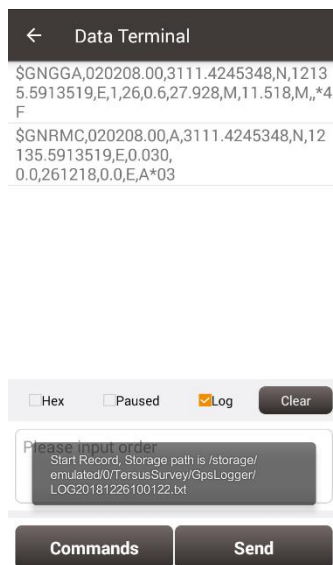

Figure 3.18 Start recording log data

Uncheck the box on the left of [Log] is to stop recording log data.

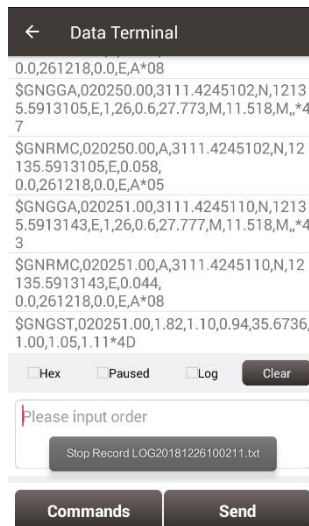

Figure 3.19 Stop recording log data

Click [Clear] to clear the screen.

Click [Commands] to output common NMEA loggings (not available for connecting Oscar).

Check the commands and click [OK], it will return to the command window with the typed commands which is shown in Figure 3.14. Then click [Send] to send the commands to communicate with Tersus receivers.

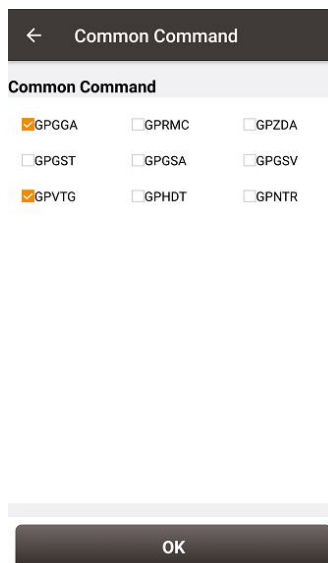

Figure 3.20 Common Command

The detailed description of log and command refers to *Log & Command Reference for Tersus BX GNSS OEM boards* which can be downloaded on Tersus website.

Note: [Commands] and [Send] are not available when Nuwa is connected with Oscar.

3.3 Base

Some default base configurations are provided for David and Oscar. Select a configuration file in the Work Mode List and click [Detail] to edit the base configuration. Click [Start] to complete the base configuration.

[Startup]: auto start or manual start

- Auto start: the position of the base is achieved automatically.
- Manual start: base coordinate is achieved by averaging collection, loaded from a point library or input manually.

[Data Link]: radio or network for **David**.

- Radio: the corrections are output to an external radio, serial baud rate should be selected accordingly.
- Network: the corrections are uploaded to a Ntrip server or TCP host. The IP address, port, password and mount point of the Ntrip server should be input manually; The IP address and port of the TCP host should be input.

Four options for data link of **Oscar**.

- External Radio: the corrections are transmitted via 25W radio for Oscar.
- Internal Radio: the corrections are transmitted via internal 2W radio of Oscar. Oscar internal radio currently supports three transmit powers of 0.5W, 1W, and 2W, and supports five protocols, TransEOT, TT450, SOUTH, SATEL, and TRIMMK3, and two corresponding air baud rates 9600bps and 19200bps. Each protocol supports ten channels and customized frequency. Select 0~9 channel on Nuwa will automatically read the corresponding frequency to the channel.
- Receiver Network: the corrections are uploaded to Ntrip server or TCP host, or Tersus Caster Service (TCS) using Oscar network. The IP address, port, password and mount point of the host should be input manually.

- PDA Network: the corrections are uploaded to Ntrip or TCP host, or Tersus Caster Service (TCS) using a PDA device. The IP address, port, password and mount point of the host should be input manually.

[Baud Rate]: the serial baud rate can be selected from 9600 to 921600, the default is 38400bps for David and 115200bps for Oscar. The air baud rate for Oscar internal radio can be selected from 9600 and 19200.

[Differential Format]: CMR, CMR+, RTCM2.3, RTCM3.0 and RTCM3.2 are supported for David; RTCM2.3, RTCM3.0 and RTCM3.2 are supported for Oscar.

3.3.1. Set David as a Base

The detailed description for each configuration of **David** as a base is shown in below screenshots.

Click [New] to create a new base configuration. In the figure below, for auto start in radio mode, baud rate is 38400 by default and can be selected in the pop-up list below. The differential format is RTCM3.2 by default.

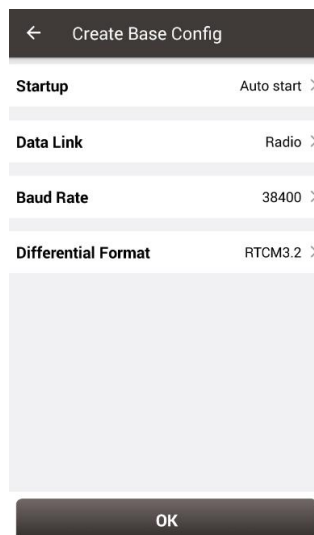

Figure 3.21 David base auto start – Radio

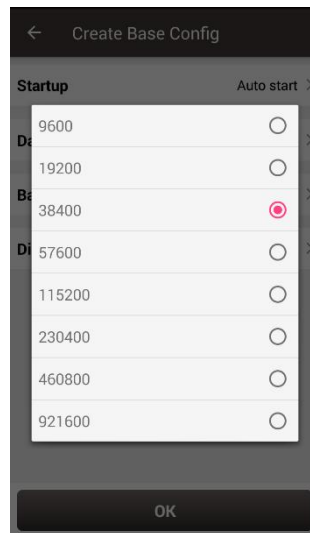

Figure 3.22 Baud rate options

The detailed information of how to use radio refers to *User Manual for David GNSS Receiver*.

In the figure below, for auto start in network mode, the host IP can be manually typed or selected by clicking the icon **IP** on the right of row Host. It shows two Ntrip servers built by Tersus GNSS Inc. and can be selected depending on different area. Please contact Tersus technical support for the two Ntrip servers. The site list can be added, edited and deleted. For Ntrip network, host IP, port, password and mount point should be input. The mount point can be customized, and it is generally recommended to enter **the last four digits of the device's SN** as the mount point to distinguish. For TCP network, host IP and port should be input. TCS is a unique protocol from Tersus, the software automatically obtains the SN of current device as base ID. Contact Tersus technical support for password and mount point information if you bought products from Tersus.

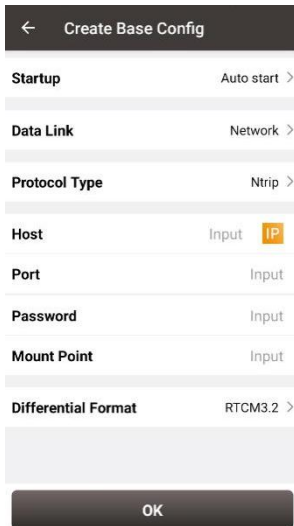

Figure 3.23 David base auto start – Ntrip

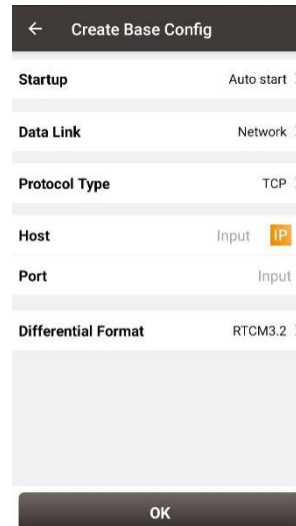

Figure 3.24 David base auto start – TCP

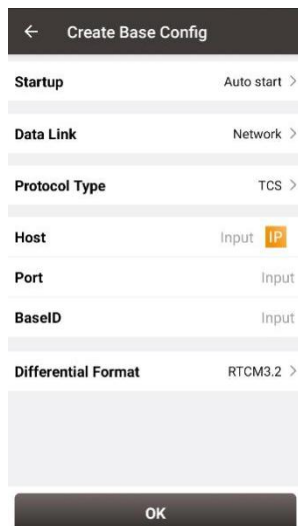

Figure 3.25 David base auto start – TCS



Figure 3.26 Ntrip Site Manager

Ntrip status viewing method when the base station is connected to Ntrip server:

Take asiacaster for example, open any browser on the computer (accessible to internet) and enter the following URL in the address bar:

<http://asiacaster1.tersus-gnss.com:2201/Ntrip.html?usr=username&pwd=password>

in which, the **username** and **password** should be obtained from Tersus GNSS Inc.

In the figure above, for manual start in radio mode, the base coordinate should be typed

manually or obtained by clicking  the location icon or imported from the survey point

library by clicking  the list icon. The other parameters setting is the same with that in auto start radio mode.

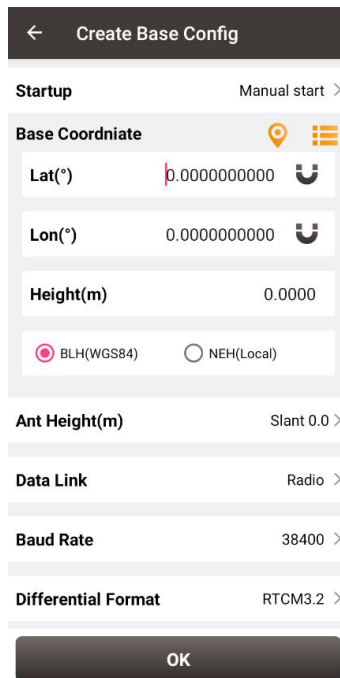

Figure 3.27 David base manual start – Radio

In the figure below, for manual start in network mode, the base coordinate setting is the same with the method mentioned above, the network host setting is the same with the method described for auto start in network mode.

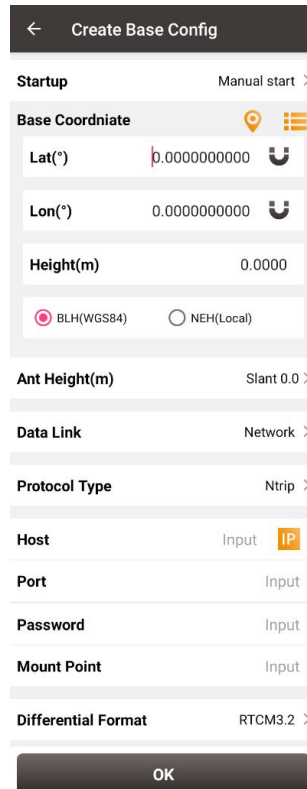

Figure 3.28 David base manual Start – Network

3.3.2. Set Oscar as a Base

The detailed description for each configuration of **Oscar** as a base is shown in below screenshots.

Click [New] to create a new base configuration.

When the startup mode is *Auto start*, the "Keep coordinates after reboot" checkbox appears. If it is checked, Oscar will keep the base station mode after reboot and the base station coordinates will be the same as before reboot. If it is unchecked, Oscar will keep the base station mode, but the base station coordinates will be regenerated by single positioning.

When the startup mode is *Manual start*, the "Keep mode after reboot" checkbox appears. If it is checked, Oscar will keep the base station mode and keep the base station coordinates. If it is unchecked, Oscar will be in single mode after reboot.

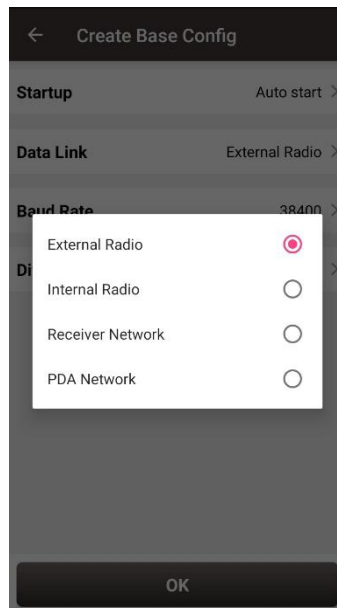
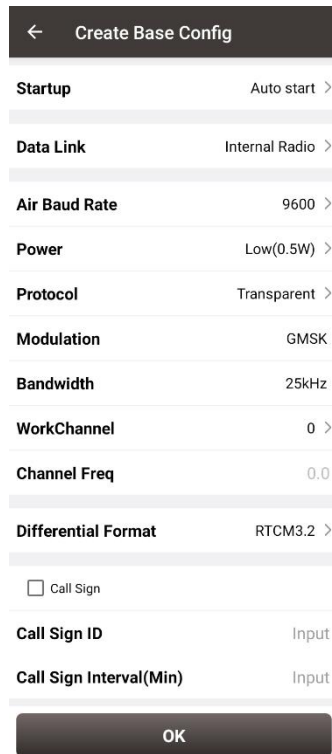

Figure 3.29 Oscar base auto start – 4 data link options

- External Radio: the configuration method of Oscar base with external radio is similar with that of David base with radio stated above. The difference is that the default serial baud rate of Oscar 25W radio is 115200bps.
- Internal Radio: if choosing to use the internal radio of Oscar, user needs to select proper air baud rate, transmitting power, protocol, channel and frequency. It also displays the modulation type and bandwidth. The call sign parameters can be configured for the internal radio. The customers in some countries or areas can configure call sign function according to requirement.



← Create Base Config	
Startup	Auto start >
Data Link	Internal Radio >
Air Baud Rate	9600 >
Power	Low(0.5W) >
Protocol	Transparent >
Modulation	GMSK
Bandwidth	25kHz
WorkChannel	0 >
Channel Freq	0.0
Differential Format	RTCM3.2 >
<input type="checkbox"/> Call Sign	
Call Sign ID	Input
Call Sign Interval(Min)	Input
OK	

Figure 3.30 Oscar base auto start – internal radio

- **Receiver Network:** if choosing to use receiver network to transmit corrections, there are three protocol options to select: Ntrip, TCP and TCS (Tersus Caster Service). Fill in the corresponding IP address, port, password, mount point and base ID if necessary to connect to the receiver network.

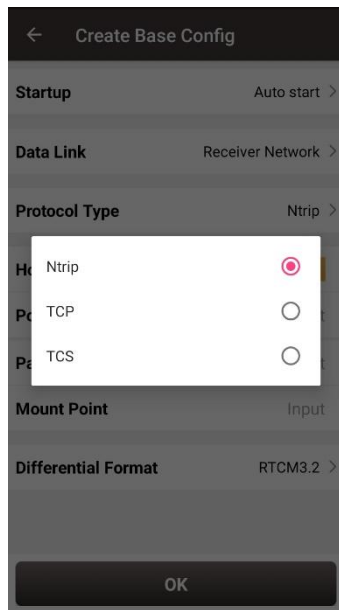

Figure 3.31 Oscar base auto start – receiver

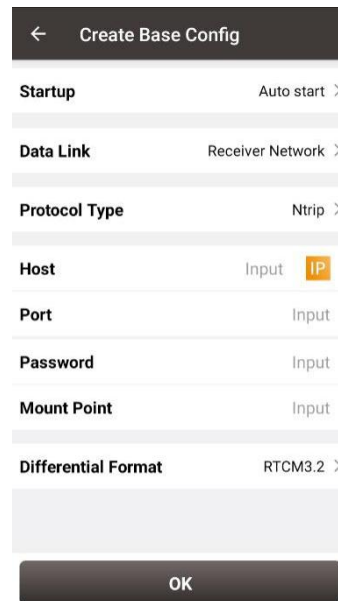

Figure 3.32 Oscar base auto start – Ntrip network

network options

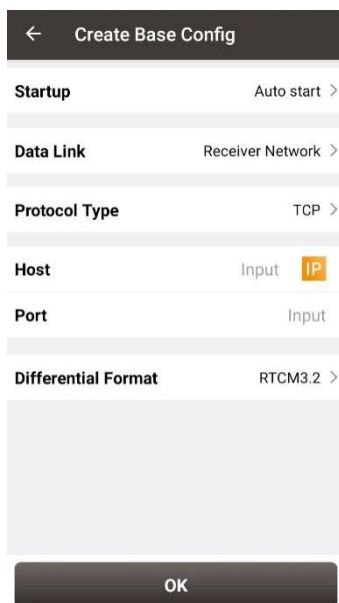

Figure 3.33 Oscar base auto start – TCP network

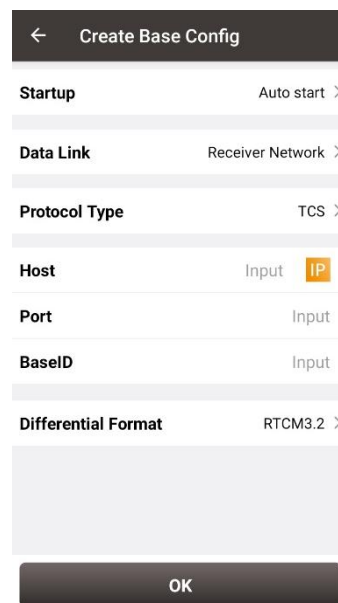

Figure 3.34 Oscar base auto start – TCS network

- PDA Network: there are also three protocol options of PDA network to select: Ntrip, TCP and TCS (Tersus Caster Service). The required information to input for different protocol is different, refer to the screenshots above.

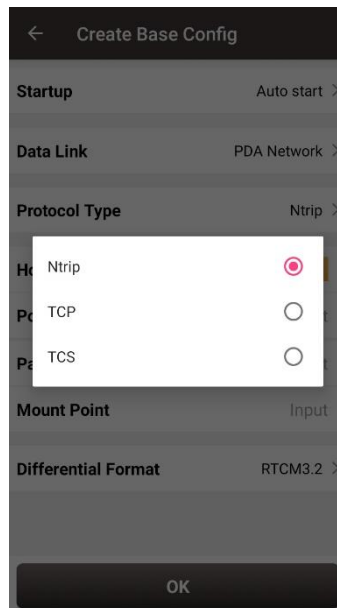



Figure 3.35 Oscar base auto start – PDA network options

For Oscar manual start in radio mode and network mode, the base coordinate should be typed manually or obtained by clicking  the location icon or imported from the survey point library by clicking  the list icon. The data link options configuration are the same with the method mentioned above in Oscar base auto start in radio and network modes.

3.4 Rover

Some default rover configurations are provided for David and Oscar. Select a configuration file in the Work Mode List and click [Detail] to edit the rover configuration. Click [Start] to complete the rover configuration.

3.4.1. Set David as a Rover

The detailed description for each configuration of **David** as a rover is shown in below screenshots.

Click [New] to create a new rover configuration. In Figure 3.35 below, for rover configuration in radio mode, the baud rate is 38400 by default and can be selected from 9600 to 921600 in the pop-up list as shown in Figure 3.21.

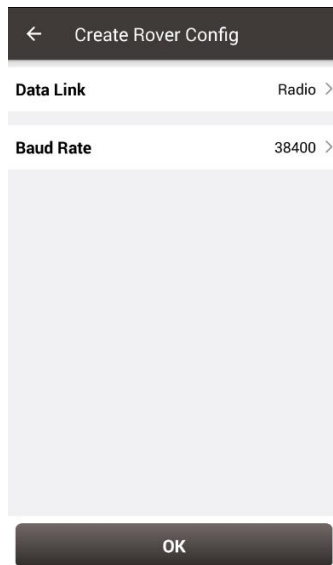

Figure 3.36 Create Rover Configuration for David – Radio

In Figure 3.36 below, for rover configuration in network mode, the protocol type can be selected from Ntrip, TCP and TCS.

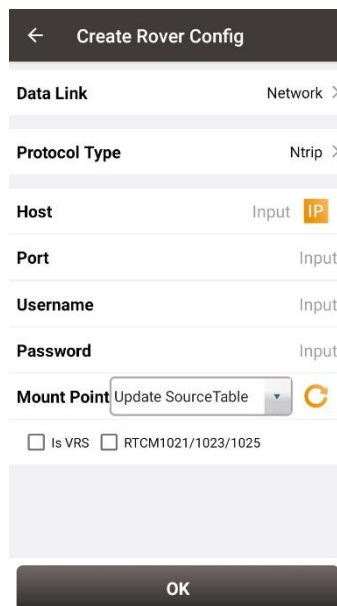

Figure 3.37 Create Rover Configuration for David – Ntrip Network

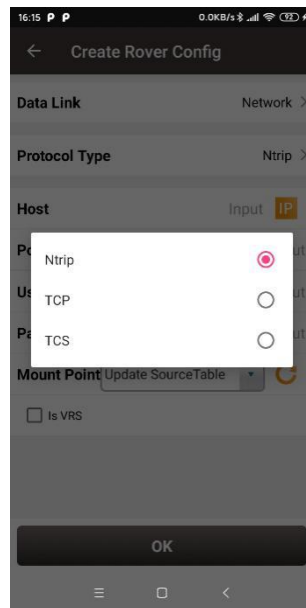

Figure 3.38 Protocol type options

When Ntrip network is selected, the host can be manually typed or selected by clicking the icon **IP** on the right of row Host as mentioned in Figure 3.25 above. The username and password should be obtained from Tersus technical support. The box on the right of Mount Point displays the mount point and differential format after clicking the refresh icon **🔄** to update the source table. The example is shown below. If the connected CORS broadcasts the RTCM1021/1023/1025 coordinate system data, after solving the data, Nuwa app will ask whether to replace the coordinate system parameter in the current project.

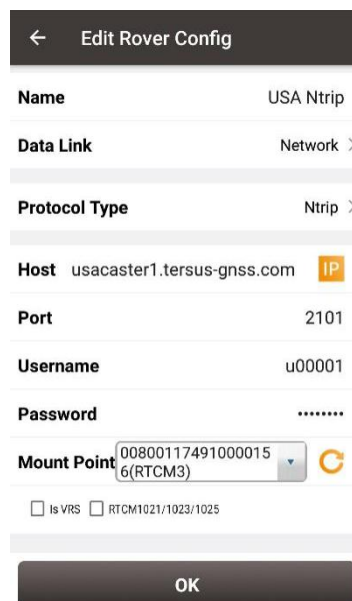

Figure 3.39 Edit Rover Configuration

When TCP is selected for protocol type, fill in the information of host and port according to customer requirements to complete the configuration.

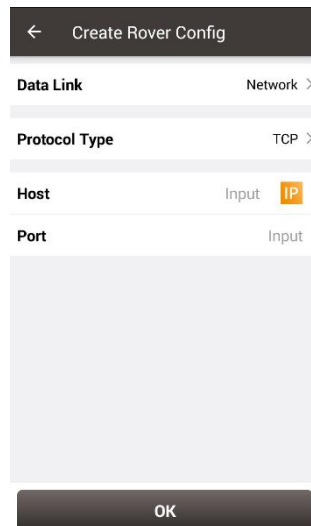

Figure 3.40 Create Rover configuration for David – TCP Network

When TCS is selected for protocol type, fill in the information of host, fill in the base ID and it will obtain differential correction data from designated base station.

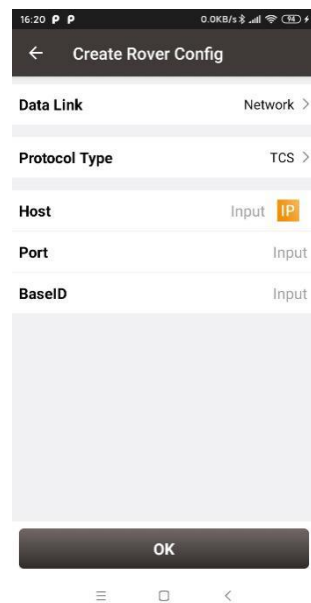

Figure 3.41 Create Rover configuration for David – TCS network

3.4.2. Set Oscar as a Rover

The detailed description for each configuration of **Oscar** as a rover is shown in below screenshots.

Click [New] to create a new rover configuration. It shows the rover configuration using the internal radio of Oscar as below. Choose appropriate baud rate, communication protocol,

work channel and channel frequency. Click [OK] and type the configuration name to complete creating a rover configuration of Oscar.

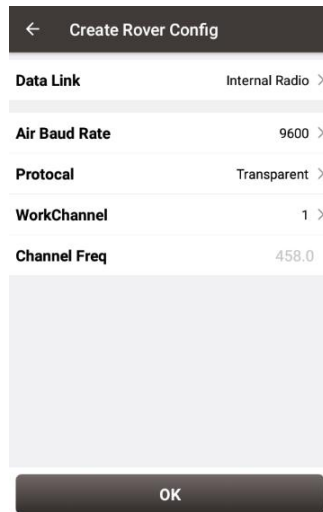

Figure 3.42 Create Rover Configuration for Oscar – Internal Radio

The data link can be selected from an option list: Internal Radio, Receiver Network and PDA Network shown as below.

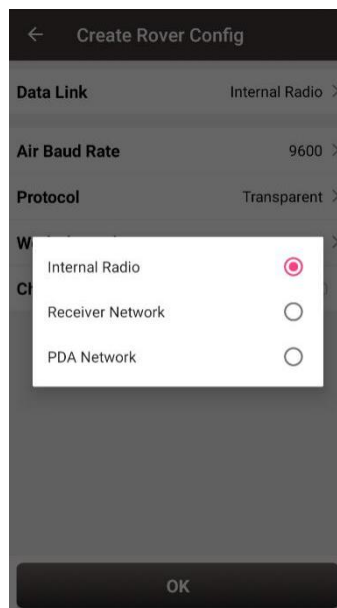

Figure 3.43 Oscar rover data link options

When Receiver Network is selected for Oscar rover communication, there are three protocol options to select: Ntrip, TCP and TCS (Tersus Caster Service). Fill in the corresponding host, port, password, mount point and base ID if necessary to connect to the receiver network.

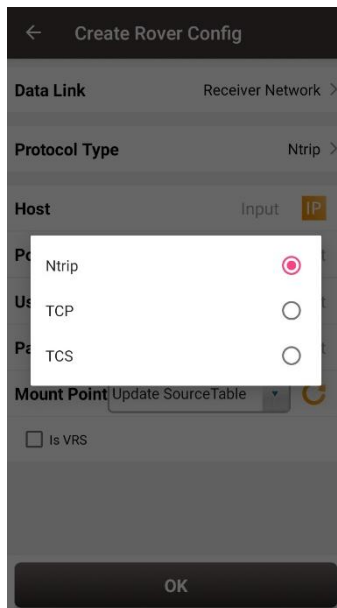

Figure 3.44 Oscar rover using receiver network – protocol options

When PDA Network is selected for Oscar rover communication, there are also three protocol options of PDA network to select: Ntrip, TCP and TCS (Tersus Caster Service).

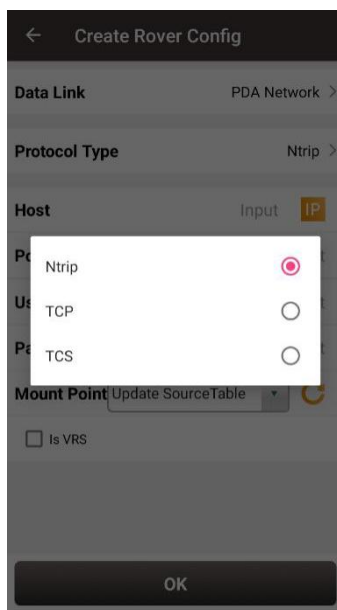

Figure 3.45 Oscar rover using PDA network – protocol options

3.5 NMEA Output

The NMEA output function is only available when Oscar receiver is connected. The serial config can be turned on or off. The baud rate can be selected in the pop-out list from 9600 to 921600 bps. The NMEA data which needs to be output via serial port can be checked.

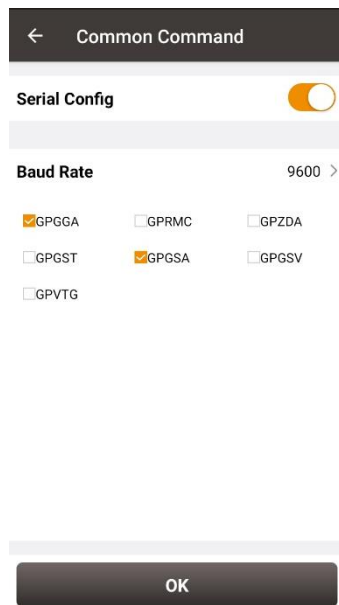

Figure 3.46 NMEA output configuration

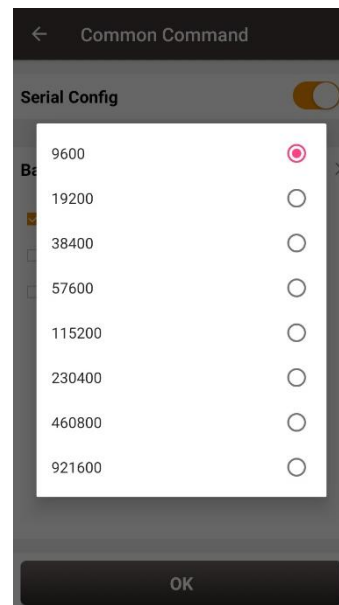

Figure 3.47 NMEA baud rate options

3.6 Device

3.6.1 David's device information

When Nuwa is connected with David GNSS Receiver, click [Device] -> [Device] to view the detailed information of David.

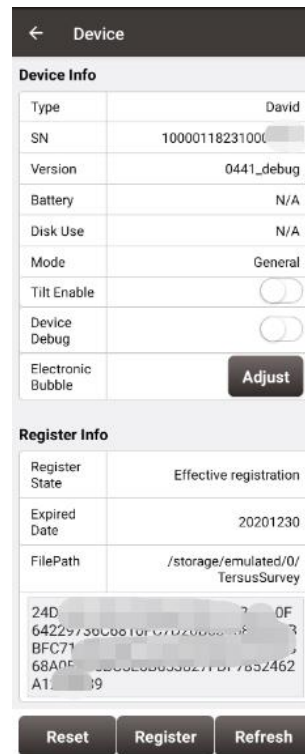

Figure 3.48 David's device info

In the figure above, the SN row displays complete serial number for David, the battery and disk use are not available. Mode indicates working mode which includes General, Base, and Rover. Tile Enable and Electronic Bubble are not available and cannot be turned on.

When the David receiver has an unknown error, turning on Device Debug to record Tersus specific data to troubleshoot receiver which can help us better improve receiver's function.

Note: This function and static survey cannot be turned on at the same time. Please manually turn off the static survey before using Device Debug.

Registration

When the registration is not effective, follow below steps to complete the registration.

- 1) Connect the TC20 controller to PC with a mini USB cable, and choose "Use USB for Transfer files" on the TC20 screen.
- 2) Click TC20 -> Internal storage -> TersusSurvey on the PC, then copy the license file (obtained from Tersus Technical Support) to the "TersusSurvey" folder.
- 3) Open Nuwa software, click [Register] in Device information interface. Click [Refresh] to update the registration status.

Note:

- a) The registration file is text format file saved as xxx.txt.
- b) David's registration file name is the same with the SN number. The example is as below.



Figure 3.49 Example of David's registration file

Clicking [Reset] resets the receiver into factory settings.

3.6.2 Oscar's device information

When Nuwa is connected with Oscar GNSS Receiver, click [Device] -> [Device] to view the detailed information of Oscar.

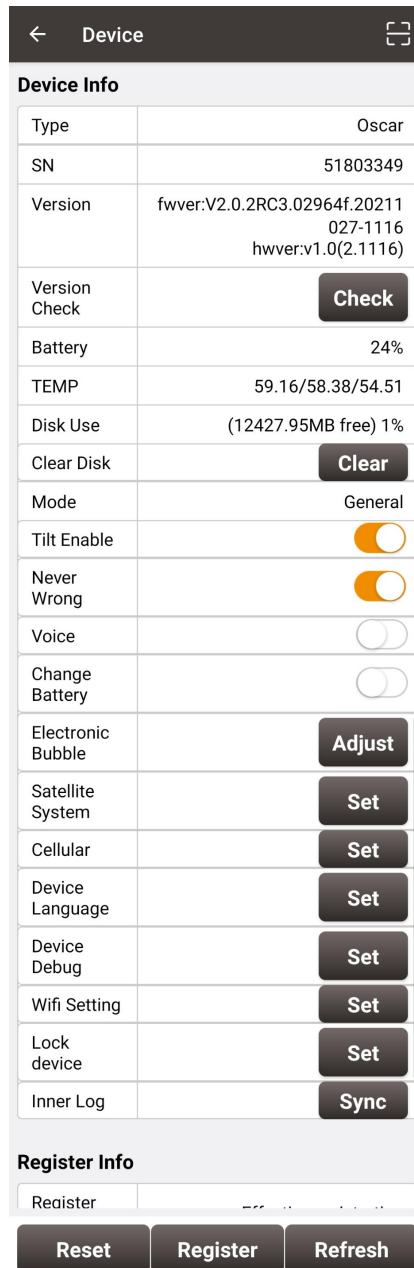

Figure 3.50 Oscar's device info

In the figure above, only displays 8 digits number for Oscar which is used for Bluetooth pairing, registration, TCS connection, and etc.

Click Version Check [Check], connecting to the server by PDA network or GSM module in Oscar, to check whether the firmware needs to be upgraded. If the firmware needs to be upgraded, the word "new" will be displayed, and click "new" to download the latest version of firmware through Oscar 4G network and upgrade the firmware.

The battery row displays remaining battery level for Oscar. The disk row shows Oscar disk usage and remaining space. The mode row displays current working mode, which includes General, Base and Rover.

Tilt Enable is the tilt compensation applicable for Oscar GNSS receiver Ultimate version working as a rover. The detailed usage of this function refers to 4.4 Tilt Survey and Stakeout.

When NeverWrong is turned on, the Oscar receiver is fixed with guaranteed accuracy; when this function is turned off, the Oscar receiver enters fixed priority mode to get a fixed solution faster.

When Voice feature is turned on, Oscar will voice over when the power is switched on and off, when Bluetooth is connected and disconnected, when the solution status is fixed and floating, and when the working mode changes.

When the battery change mode is turned on, turn off the receiver, replace the battery and restart the device, and it will maintain the working mode before shutting down; if the base station is in auto start mode before shutting down, the original auto-start base station coordinates will be maintained; if the base station is started at a known point before shutting down, it will keep the mode of starting at the known point; if it was at rover mode before shutting down, it will keep the rover mode after changing battery.

Electronic Bubble (eBubble)

This function is only available for Oscar GNSS Receiver. Make the body of Oscar stand on a leveled Tribrach before eBubble calibration.

Click  on the right of electronic bubble to adjust bubble. On the screenshot below, the eBubble is not in the black circle and its color is red for warning purpose.

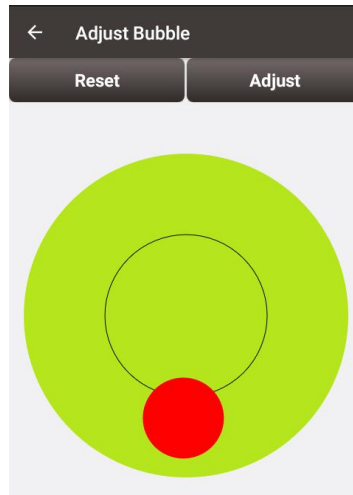

Figure 3.51 eBubble before adjusting

Click **Adjust** on the right, the eBubble is calibrated to the center inside the black circle and the bubble color turns blue.

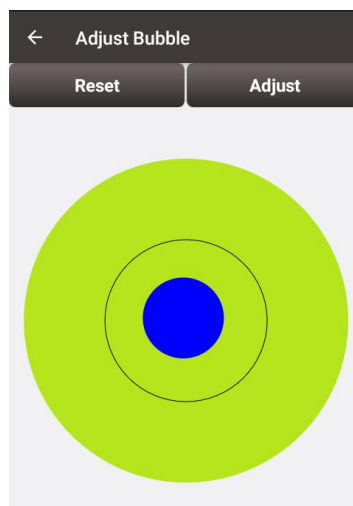

Figure 3.52 eBubble after adjusting

Click Satellite System [Set], to select the system of satellite tracking for the receiver.

Click Cellular [Set], to view the status and configure the APN of network module in Oscar antenna.

Click Device Language [Set], to configure Oscar panel display language and Oscar voice language.

Click Device Debug [Set], to determine whether each module inside Oscar needs to record the log information.

Click Wifi Setting [Set], to set Wifi module of Oscar to OFF, AP mode or STA mode.

Click Lock device [Set], to set the password of Oscar. After the password setting, a password should be entered for verification when connecting to the Oscar. Click Unlock to cancel the password setting.

Click the Inner Log [Sync], after connecting the USB flash drive to the Oscar receiver through the OTG cable, to copy the logs recorded in Oscar to the USB flash drive and then provide it to Tersus to verify and solve various problems that occurred in the field.

Registration

When the registration is not effective, there are two methods to complete the registration.

One is using USB cable and a computer.

- 1) Connect the TC20 controller to PC with a mini USB cable, and choose "Use USB for Transfer files" on the TC20 screen.
- 2) Click TC20 -> Internal storage -> TersusSurvey on the PC, then copy the license file (obtained from Tersus Technical Support) to the "TersusSurvey" folder.
- 3) Open Nuwa software, click [Register] in Device information interface. Click [Refresh] to update the registration status.

Note:

- c) The registration file is text format file saved as xxx.txt.
- d) The Oscar's registration file name consists of the first three digits and the last five digits of the SN number. The example is as below.

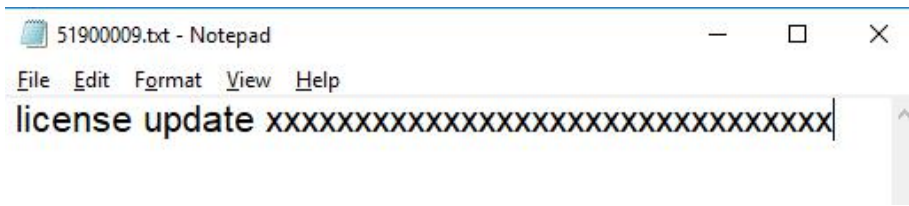

Figure 3.53 Example of Oscar's registration file

The other method is registering using QR code.

Click the scan button at the top right of the device information interface and directly scan the QR code provided by Tersus to complete the registration.

Clicking [Reset] resets the receiver into factory settings.

4. Survey

- Survey
- Point Stakeout
- Line Stakeout
- Static Survey
- Point Correction
- Survey Config
- Base Shift
- Road Stakeout

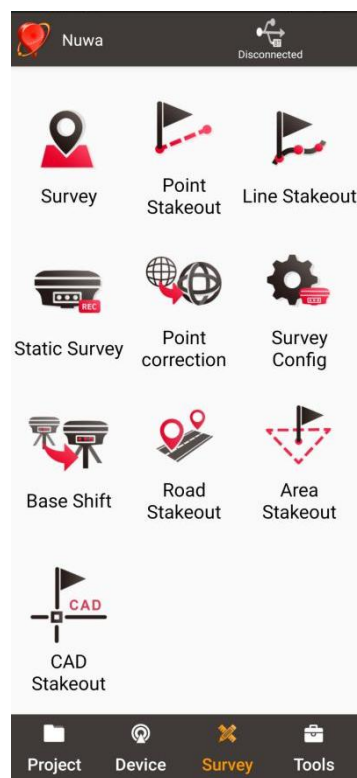

Figure 4.1 Functions under Survey

4.1 Survey

The Survey interface includes: status bar, background map, tools and information.

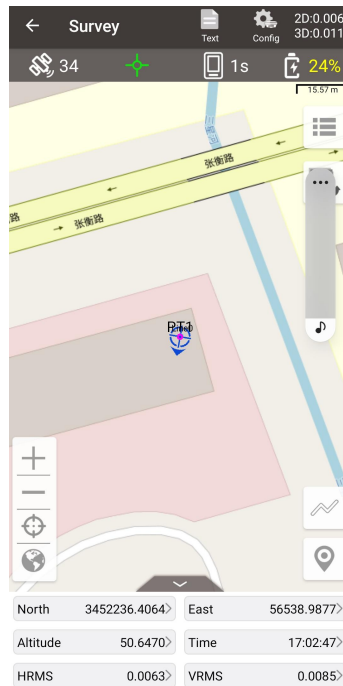

Figure 4.2 Survey – Drawing mode

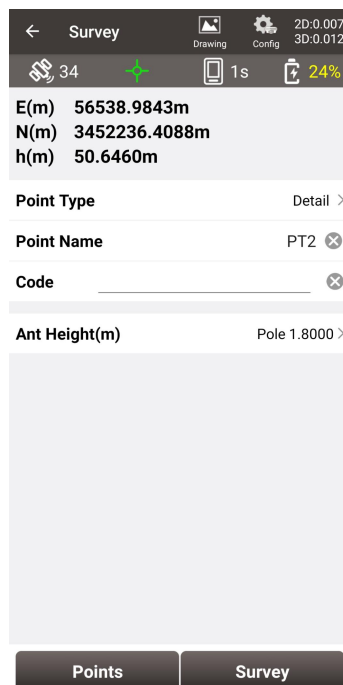

Figure 4.3 Survey – Text mode

➤ Status Bar



[Text]: the main interface is shown in text mode or drawing mode, click this icon to switch between the two modes.



[Config]: Survey Configuration, refer to section 4.6 for more details.



[Connected]: connection status with a Tersus GNSS receiver, refer to Connect for more details.







[Satellite icon]: satellite icon, with the number of satellites involved in solution on the right, e.g., 23 means 23 satellites are used.



[Solution status icon]: solution status, includes Single , Float , Fixed , None .



[Data link type icon]: data link type, includes Single mode , Base mode , Rover UHF

mode , Rover GSM mode , Rover PDA Network mode , with the number of Diff Age on the right. If the Diff Age is greater than the Diff Age Limit in survey config, the number is displayed in red.



[Tilt status icon]: tilt status, includes tilt enable  and tilt disable .



[Battery icon]: battery icon, with the number of the remaining battery power of Oscar GNSS receiver on the right. Currently it is not supported of displaying the battery of David as there is no embedded battery in David receiver.

➤ Background Map



[Survey point library icon]: view and edit the survey point library.



[Map selection icon]: click it to switch among none, OSM online map, Google online map, Google online map (China) and Google online aerial map.

If you put some base maps in .dxf format under the file path: internal storage\TersusSurvey\Maps, you can check the DXF map besides one online map. Then choose the .dxf map you want to display in the pop-out file list.

Note: before loading a DXF base map, ensure the coordinate system parameters in the current project are consistent with the coordinate system parameters in the DXF base map.

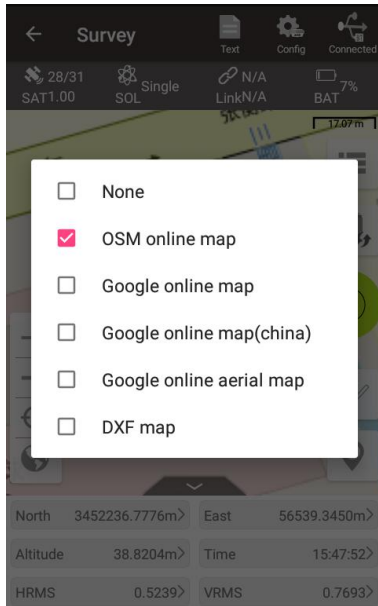

Figure 4.4 Map options

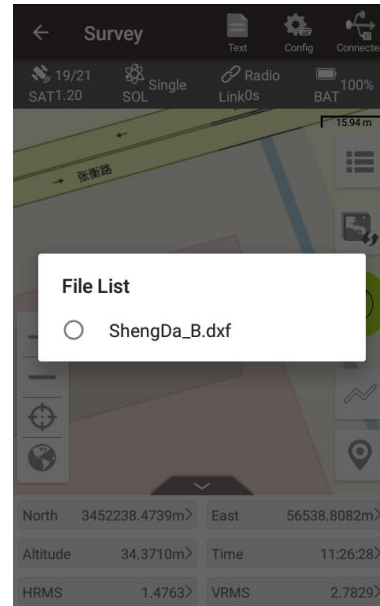

Figure 4.5 DXF file list

After the dxf map is selected, Nuwa app will load the map. Select one point on the DXF base map, it prompts whether to stakeout the selected point. If you click OK, it switches to the point stakeout interface to stakeout this point.

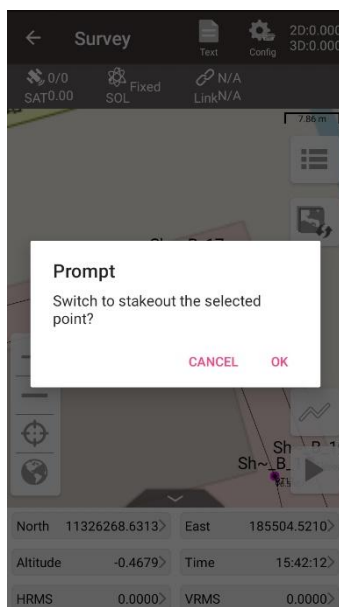

Figure 4.6 Prompt to stakeout the point



Figure 4.7 Switch to point stakeout

Select a line on the DXF base map, it prompts whether to stakeout this line. If you click OK, it switches to the line stakeout interface to stakeout this line.

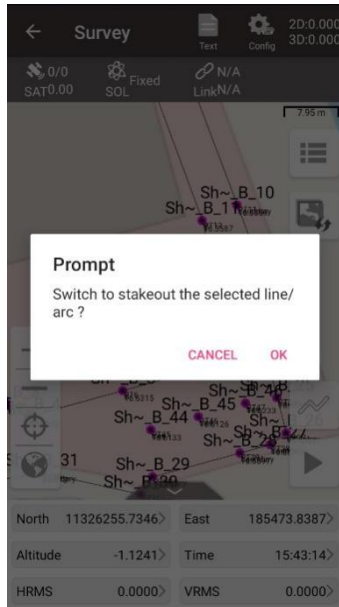

Figure 4.8 Prompt to stakeout the line

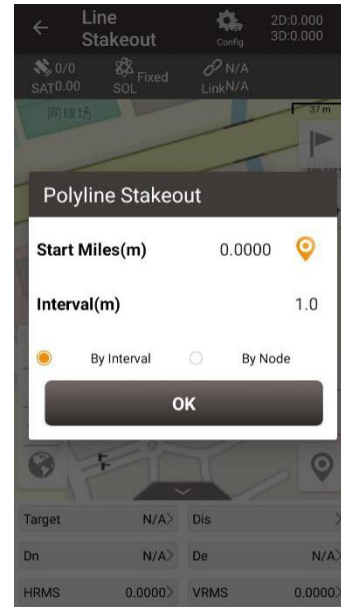

Figure 4.9 Switch to line stakeout

[+]: zoom in the map.

[-]: zoom out the map.

[📍]: zoom with the current location at the center.



[🌐]: place all the points in one view.

➤ Tools



[📍]: electronic bubble: indicates leveling bubble calibration status. The bubble is blue when it is calibrated to the center inside the black circle, and is red when it is not calibrated to the center circle.



[📐]: Linework function: After clicking this icon, enter the line name and other information. Click [OK] and the hollow line becomes a solid line in the icon. Then it starts collecting the survey points (including continuous points and smooth points) which will be connected into a line. The line is saved in the line list. When the acquisition is completed, click again this icon, choose to Close  or Non-close  the line. The icon changes back to the initial state and ends line acquisition. After this, the collecting survey points will not be connected to the line.

If entering the existing line name instead of a new one, it supports to continue the linework survey selecting from start or from end point.

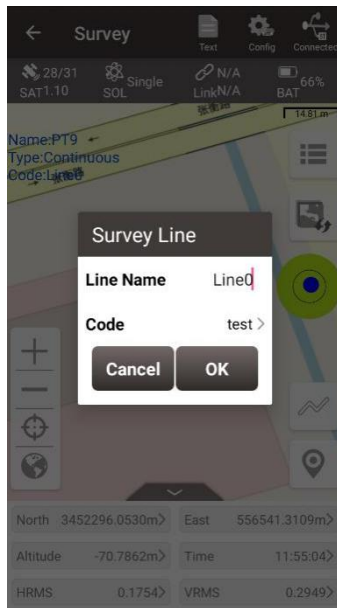

Figure 4.10 Enter an existing line name

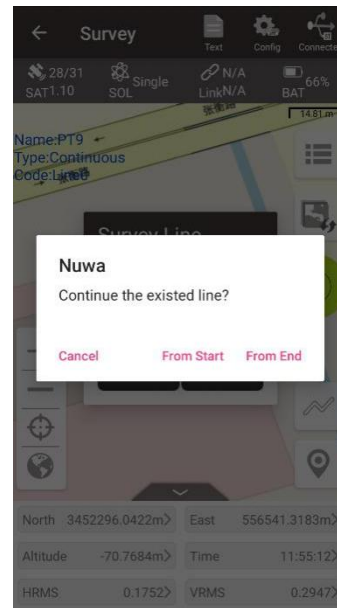

Figure 4.11 Continue the existing line options

After survey points are collected, information in blue color is displayed at the up left corner. There are two methods to collect survey points:

[▶]: Auto collect when selecting continuous for survey mode, refer to section 4.7.1 Common Config for more details.

[📍]: Manual collect, it will display this icon when selecting detail for survey mode.

➤ Information Bar

Six information items are displayed, each can be chosen from the 21 items in the following screenshots.

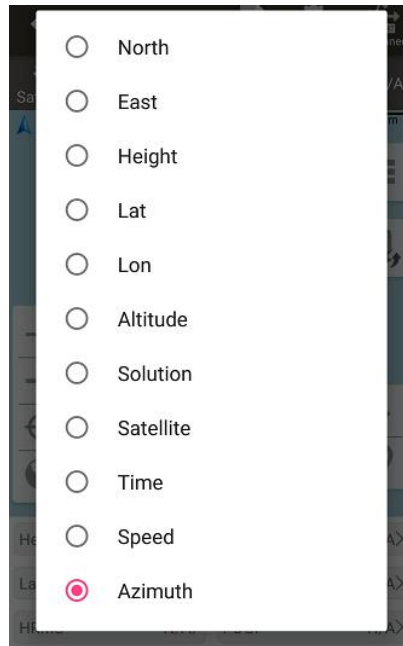

Figure 4.12 Information option list – part 1

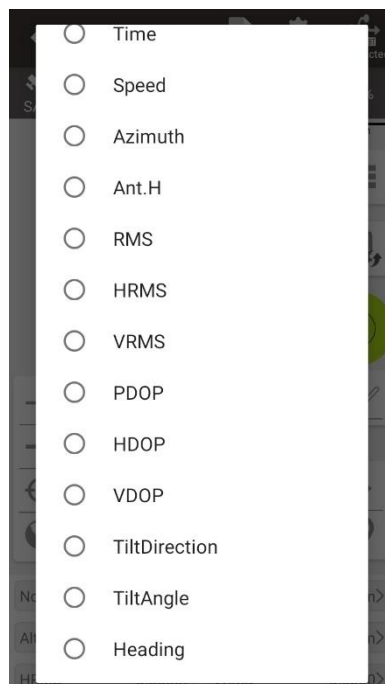

Figure 4.13 Information option list – part 2

4.2 Point Stakeout

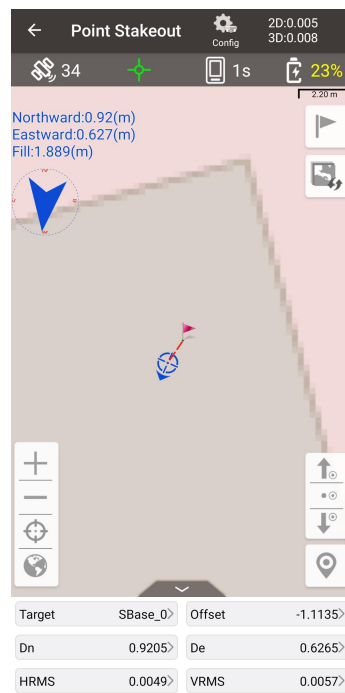



Figure 4.14 Point Stakeout interface

The above screenshot is the main interface of point stakeout, which is similar to that of point survey.



The main steps of point stakeout are as follows:

- Add stakeout point: click  to enter the stakeout point library which is shown in Figure 4.13 below, refer to section 0 for point library management.
- Select the point to be stakeout: select the point, then click [Select].

← Stakeout Point		
5 features		Multiselect
id	Name	N
L5	SPT1	3452290.9209
L2	SPT2	3452290.9220
L3	SPT3	3452290.9269
L4	SPT4	3452290.9225
L6	SPT9	3452248.6325

Add	Edit	Import	Select
-----	------	--------	--------

Figure 4.15 Add stakeout point

- The offset between the current point and the target point is displayed on the screen. The arrow icons  and  are used to switch the stakeout points in the library. The icon  is used to switch to the nearest stakeout points in the library.
- If the display all staking point and point name are checked in Survey Config - Display Config, directly clicking on the point to be stake on the map can also used to switch the staking points.

In the point stakeout interface,

- The red flag indicates the location of the stakeout point.
- The red dotted line is the connection between the current point and the point to be staked.
- The small blue arrow is the point to be staked.
- The small blue arrow pointing towards the surveyor heading.
- The big blue arrow prompts the surveyor that the point to be staked is in the front/rear/left/right position.
- The blue number shows the distance from the point to be staked in different directions.

4.3 Line Stakeout

There are four circumstances of line stakeout: straight line stakeout, polyline stakeout, arc stakeout, and circle stakeout.

(1) Straight line stakeout

Click  to enter stakeout line library, plot the staking line on the map, and the software will mark the target point and the direction of the staking line directly according to the staking properties of the staking line (stake to pile interval or stake to vertical point).

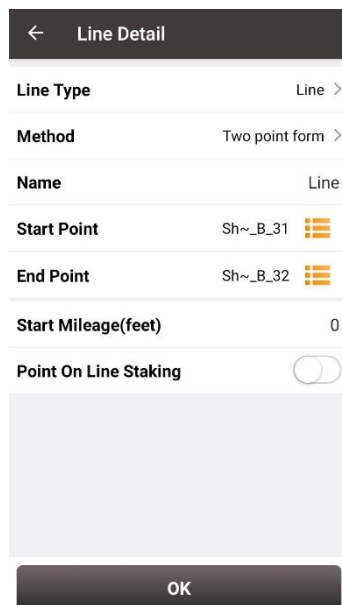

Figure 4.16 Configure straight line stakeout



Figure 4.17 Stakeout a straight line

(2) Polyline stakeout

Select to stake out to the pile point or to the node. Stake out to the pile point starts from the beginning of the polyline according to the pile interval, but stops at the node; stake out to the node will directly stake out the end points of each line segment of the polyline.

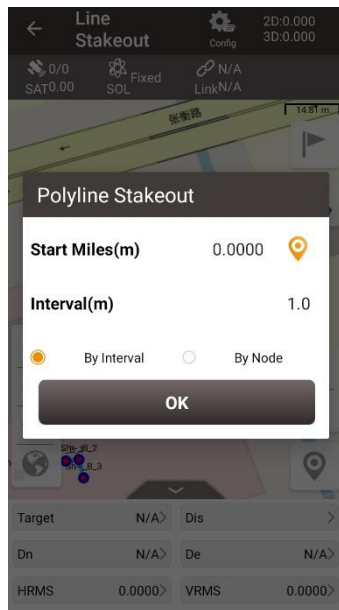

Figure 4.18 Configure polyline stakeout

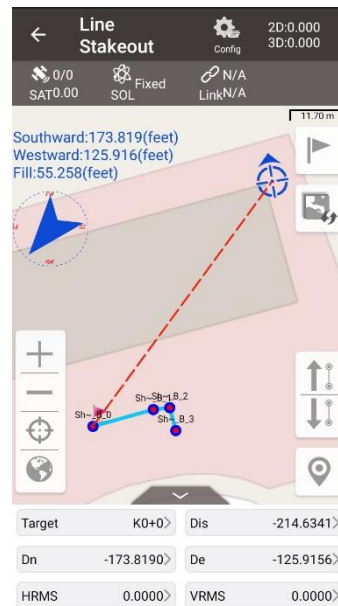

Figure 4.19 Stakeout a polyline

(3) Arc stakeout

Select to stake out to the pile point or to the center of a circle. Stake out to the pile point is to stake out sequentially from the starting point of the polyline according to the pile interval; stake out to the circle center is to stake out directly to the center of this arc.

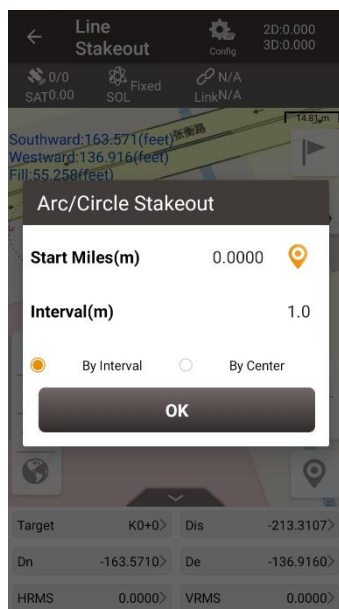

Figure 4.20 Configure arc stakeout



Figure 4.21 Stakeout an arc

(4) Circle stakeout

Select to stake out to the pile point or to the center of a circle. Stake out to the pile point is

to stake out clockwise from the northernmost point on the circle according to the pile interval; stake out to the circle center is to stake out directly to the center of this circle.

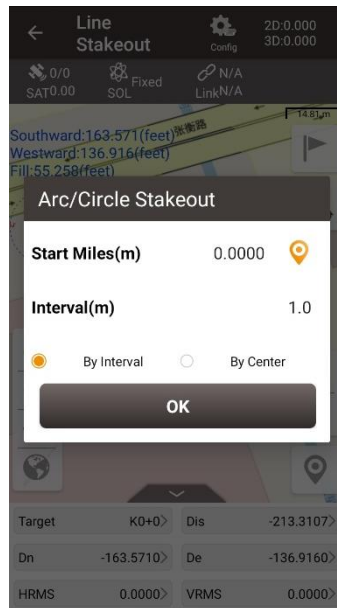

Figure 4.22 Configure arc stakeout

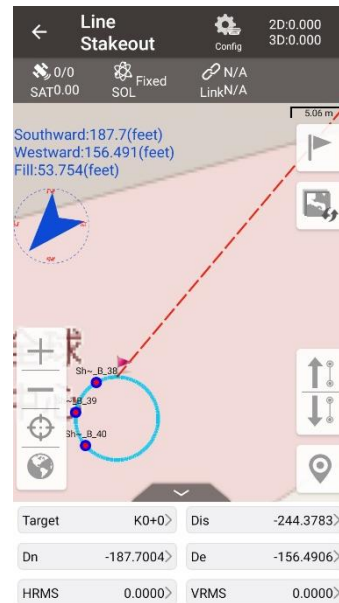

Figure 4.23 Stakeout a circle

In the above screenshot of line detail,

[Line Type]: line is the only line type currently.

[Method]: two methods to add a stakeout line, details refer to section 2.5.1.

[Name]: the line name can be modified manually.

[Start Mileage]: the mileage at the starting point, used to calculate mileage at subsequent points.

[Point On Line Staking]: when this button is turned on, stake out points on the line (or offset line) according to the entered Interval and Offset; when this button is turned off, stake out directly to the line, that is, stake out to the vertical cross point of the current position and the selected line.

[Stakeout Interval (m)]: the interval distance of the points on the stakeout line, which means stake out a point every certain distance.

[Offset (m)]: the offset when staking out the points on the stakeout line. When it is negative, it is to the left of the line forward direction. When it is positive, it is to the right of the line forward direction.

➤ Select the stakeout line, click [Select].

- Stake out from the starting point (+ offset), stake out the next point every interval distance. The distance from the current position to the target position will be displayed on the screen

4.4 Tilt Survey and Stakeout

Tilt function is only applicable for Oscar GNSS receiver Ultimate version under Rover mode.

4.4.1 Tilt Initialization

The tilt compensation of Oscar GNSS Receiver Ultimate version is free of calibration. The tilt compensation will be initialized when the surveyor walks forward naturally for several meters after the Oscar Ultimate gets RTK fixed solution status. You can start tilt survey right after you walk to the survey point.

There are two methods to turn on or off tilt compensation. One is turning on or off tilt compensation on Device Info on the OLED via buttons. Another method is through Nuwa app. After the Oscar GNSS receiver Ultimate version is connect in Nuwa app, and it is configured working as a Rover. Click the device icon  on the top or click [Device] under the device functional group to enter the device information interface. Turn on the [Tilt Enable] on the device interface, and then confirm the antenna height.

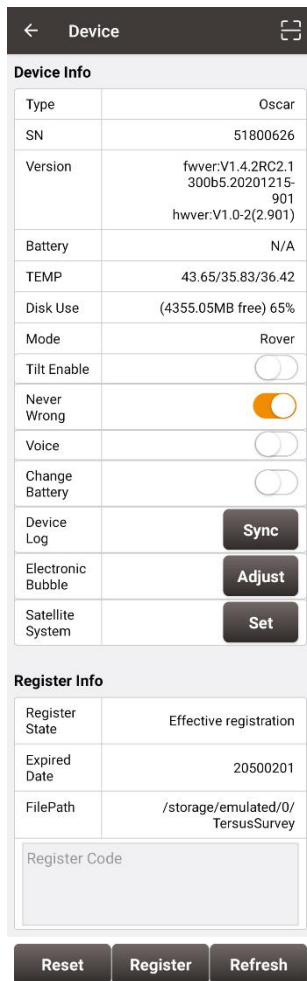

Figure 4.24 Enable Tilt in device info

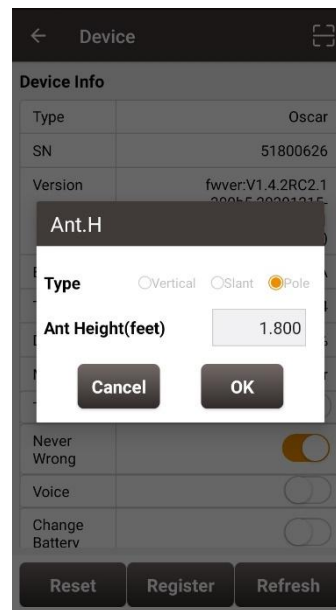

Figure 4.25 Setting antenna height when enabling tilt compensation

When tilt function is enabled, the tilt LED on the Oscar Ultimate OLED display lights on with steady red. When the solution status is single, it flashes red. When the solution status is RTK float, or the solution status is RTK fixed while tilt compensation is invalid, it changes to flashing green. When RTK solution status is fixed and the tilt compensation is available, the tilt LED turns steady green.

When the tilt compensation is valid, click the Satellite info icon to view the detailed information of tilt compensation including tilt status, tilt direction, tilt angle, heading and their quality index. Among them, the tilt direct indicates which direction is tilted, that is, the angle between the projection of the ranging pole on the ground and the north direction after tilting; the tilt angle indicates the degree of tilt, that is, the angle between the tilted pole and the vertical direction; Heading indicates the surveyor's orientation (the facing of

Oscar's back, we consider Oscar's panel is always facing the surveyor).

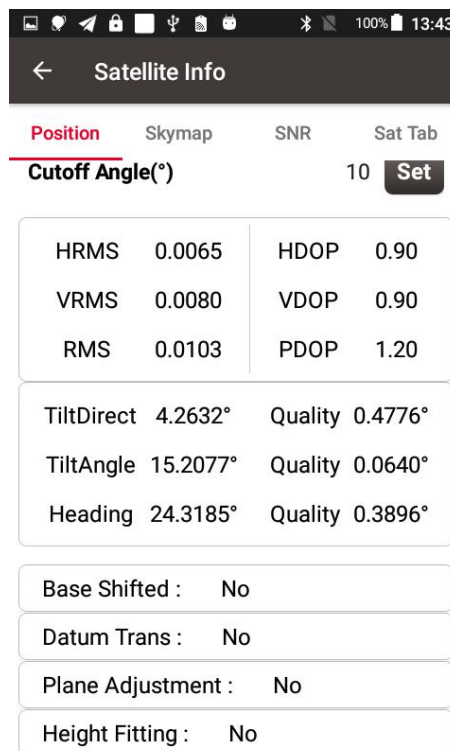

Figure 4.26 Detailed information of tilt compensation

4.4.2 Tilt Survey

After turning on [Tilt Enable] and tilt initialization is finished, enter Survey interface and start tilt survey.

The tilt status is displayed at the top of the survey interface. When the tilt status is ON, it is considered that the tilt compensation accuracy is high and it is in a usable state. You can start survey using the tilted ranging pole. Please ensure that the antenna height setting is correct which will affect the tilt measurement results.

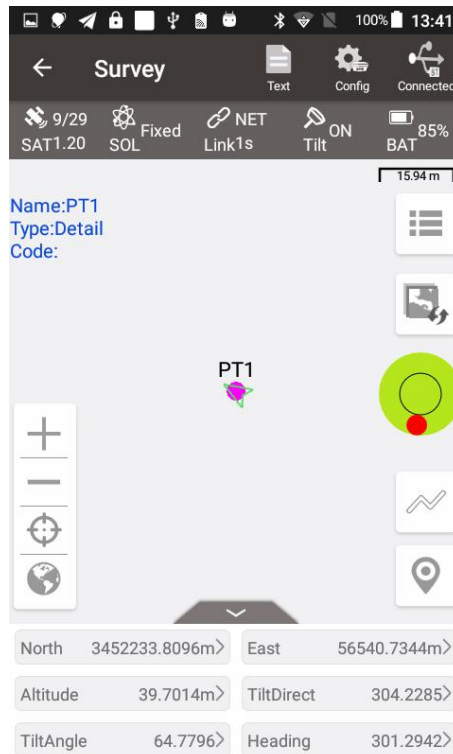

Figure 4.27 Tilt status is ON

When the status is displayed as N/A and blinking, it is considered that the accuracy of tilt compensation is reduced and it is in a state that is not recommended. At this time, the tilt indicator of the Oscar Ultimate OLED display turns flashing green. This may be caused by the surveyor standing for too long, rotating the ranging pole, or hitting the ranging pole to the ground. When the status is N/A, you need to redo the initialization. Generally, you do not need to stand still, just hold the ranging pole and walk forward to the next point, the initialization is complete automatically.

Note: during the tilt survey, please keep the Oscar OLED display facing the surveyor as much as possible. Please do not rotate the pole or hit the pole to the ground, which will invalidate the initialization or affect the accuracy of the tilt compensation. In addition, during the tilt point survey, if it does not continue at the third epoch reached when it is set smoothing 5 epochs for surveying points, please check whether the tilt compensation is invalid. It is not allowed to continue to complete the survey in the case where the tilt initialization accuracy is low.

4.4.3 Tilt Stakeout

After turning on [Tilt Enable] and tilt initialization is finished, enter the Point Stakeout or Line Stakeout interface can start tilt stakeout. The tilt state is also added at the top of the stakeout interface to indicate the current tilt available state.

During the tilt stakeout process, if you enter the threshold range of the stakeout setting, the software will display a virtual tilt ranging pole along with the beep sounds. It is drawn according to the tilt direction angle. When the pole is tilted in a certain direction among east, west, south and north, the virtual tilt ranging pole on the interface will also tilt in a certain direction.

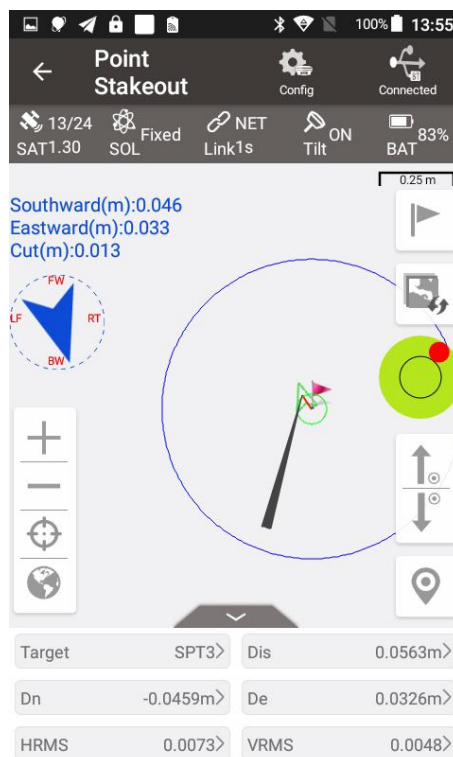
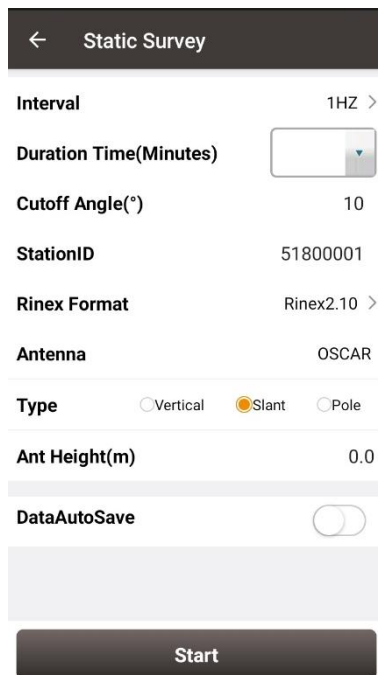

Figure 4.28 Point stakeout when tilt compensation is on

4.5 Static Survey



Static Survey

Interval 1HZ >

Duration Time(Minutes) [input field]

Cutoff Angle(°) 10

StationID 51800001

Rinex Format Rinex2.10 >

Antenna OSCAR

Type Vertical Slant Pole

Ant Height(m) 0.0

DataAutoSave

Start

Figure 4.29 Static Survey interface

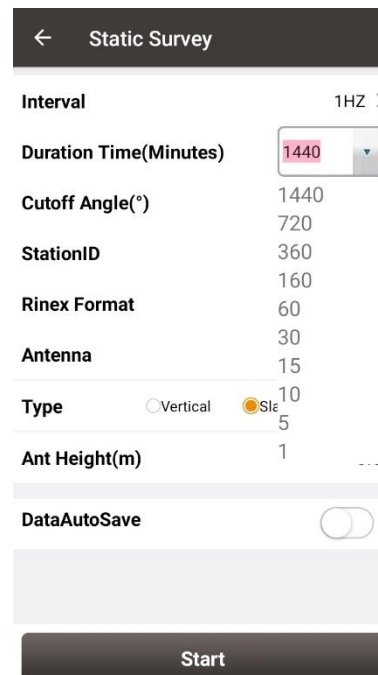

Static Survey

Interval 1HZ >

Duration Time(Minutes) 1440 [dropdown menu]

Cutoff Angle(°) 1440

StationID 720

Rinex Format 360

Antenna 160

Type Vertical Slant

Ant Height(m) 60

DataAutoSave

Start

Figure 4.30 Duration options

[Interval]: selected from 10HZ, 5HZ, 1HZ, 5S and 10S. The max rate is determined by the device connected.

[Duration Time (Minutes)]: static survey duration, the recording time can be selected in the drop down list or typed manually.

[Cutoff Angle]: the elevation mask angle, usually set to 15°.

[StationID]: the name of the surveying station.

[Rinex Format]: selected from Rinex2.10, Rinex3.02, and NONE. If configure using Nuwa, it will save trs file by default.

[Antenna]: the antenna type.

[Type]: selected from vertical, slant or pole.

[Ant Height]: the height of the antenna.

[DataAutoSave]: if this function is turned on, when the static recording time reaches the set duration, Oscar closes the current file record, reopens a file to continue recording, and this cycles; Oscar will also reopen a file to continue recording static when restart. If this

function is turned off, Oscar will stop static recording when the recording time reaches the set duration.

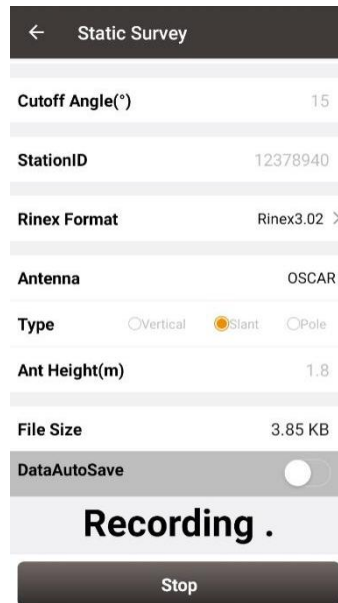

Figure 4.31 Static data recording

After all the parameters are confirmed, click [Start] to start data collection. The static data is recording as shown in the above figure.

Note: Static Survey and Device Debug cannot be used at the same time. Please turn off Device Debug as shown in Figure 3.49 manually before recording static data.

Static data download and post-processing

4.5.1 Static data download for David

Device preparation

- A David GNSS receiver
- A DC-2pin to USB power cable
- A COMM2-7pin to USB & DB9 cable
- A power bank
- A computer running TersusDownload tool



Figure 4.32 Preparation for Static Data Process

After the static survey in fields is completed, connect the David receiver to the computer according to the following figure and power on the David receiver. The USB port is mapped to a serial port (COM5 in the following example) in the computer, which can be checked in the Device Manager.



Figure 4.33 Connections of David, computer and power bank

It is recommended to type UNLOGALL in the command window of Tersus GNSS Center software before executing below steps. Open the TersusDownload on the computer, select the serial port to communicate with the David receiver.

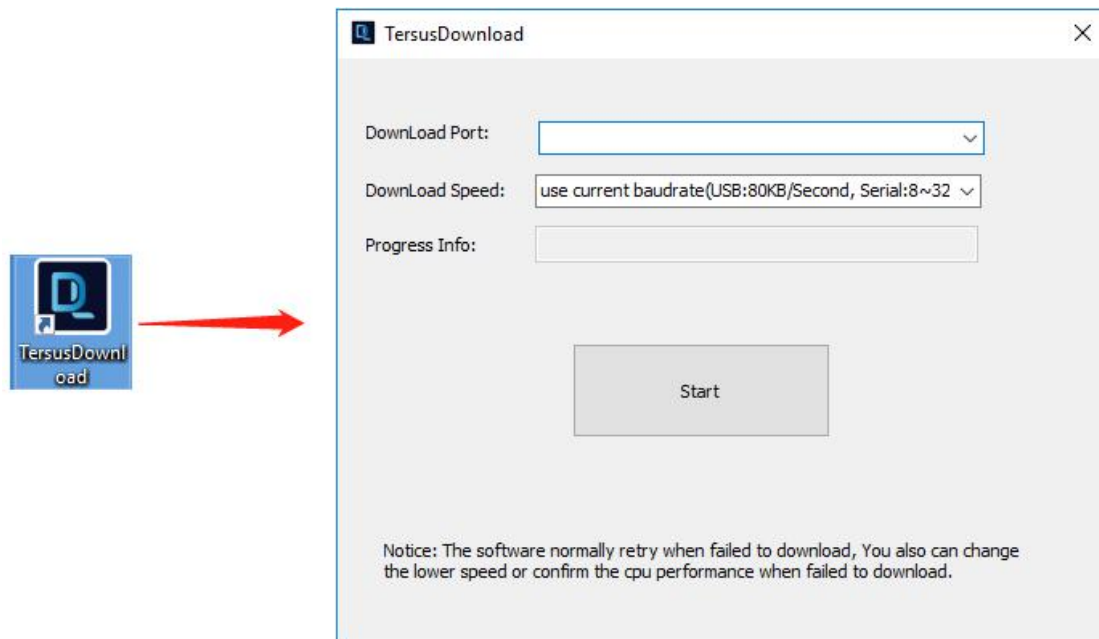

Figure 4.34 TersusDownload interface

Select the download speed. Select 'use current baudrate' when using USB port to download files as shown below. Select baud rate 460800bps if a serial port is used to download files.

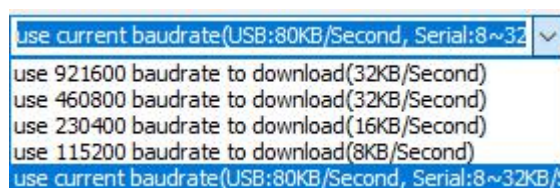

Figure 4.35 Download speed options

After completing the above steps, click [Start] and it pops out below window. Select the DownloadPath, select the files to be downloaded, click [Download] to start downloading:

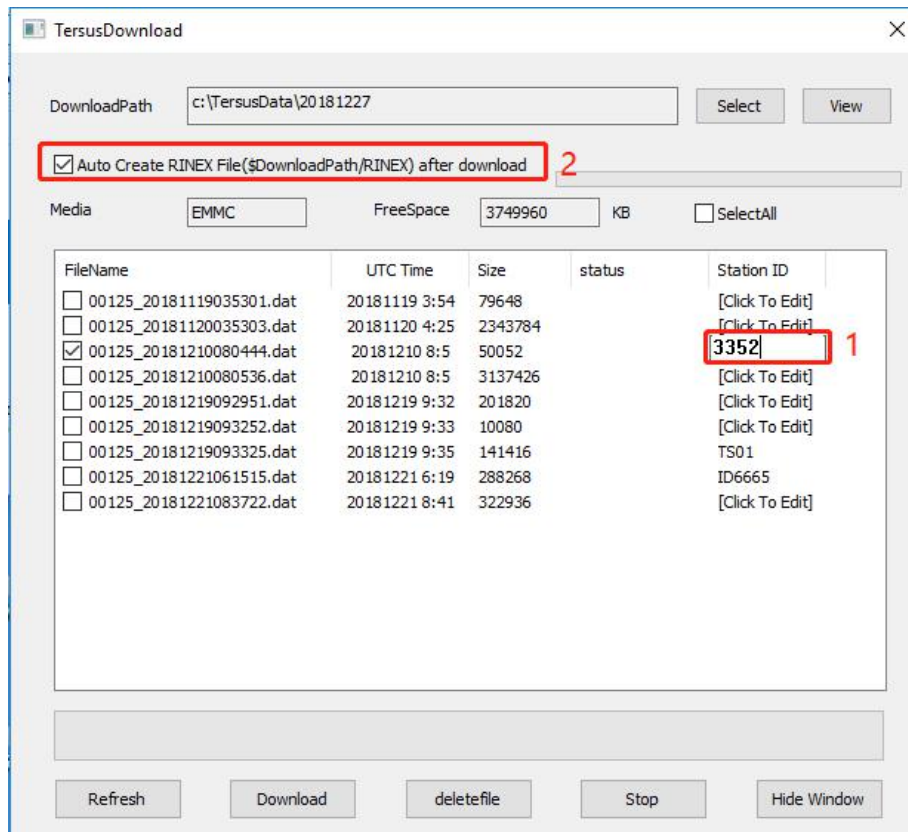

Figure 4.36 File selected for download

In this interface, click the number in red box 1 to edit Station ID if necessary, or it can be edited in Figure 4.20 in section 4.4 Static Survey. Check the box in the left of red box 2 to enable or disable auto create RINEX file after download.

!	The downloading rate is about 2MB/min, the downloading time can be estimated based on it.
!	It is recommended to ensure the computer has available CPU and memory when downloading files.

Open the RINEX file using notepad or other text viewing software, the antenna height is vertical height which is from the phase center of the antenna to the point on the ground. The value of the antenna height can be found as shown below.

```

3.02 OBSERVATION DATA M (MIXED) RINEX VERSION / TYPE
Tersus Tersus 2019-03-19 10:12 PGM / RUN BY / DATE
Test MARKER NAME
Tersus MARKER NUMBER
Tersus OBSERVER / AGENCY
TRSAX3702 NONE REC # / TYPE / VERS
-2860999.0400 4651726.0655 3283992.2949 ANT # / TYPE
1.0375 APPROX POSITION XYZ antenna height
1.000 ANTENNA: DELTA H/E/N
G 8 C1C L1C D1C S1C C2P L2P D2P S2P INTERVAL
C 8 C1I L1I D1I S1I C7I L7I D7I S7I SYS / # / OBS TYPES
R 8 C1C L1C D1C S1C C2P L2P D2P S2P SYS / # / OBS TYPES
2019 3 19 9 38 19.0000000 GPS TIME OF FIRST OBS
2019 3 19 10 12 3.0000000 GPS TIME OF LAST OBS
END OF HEADER
> 2019 03 19 09 38 19.0000000 0 24
G01 20477692.414 107611001.758 1744.113 46.000 20477694.438 83852737.918 1359.066 47.000
G07 20644342.445 108486749.574 -771.430 46.000 20644342.602 84535126.090 -601.168 44.000
G08 21771518.555 114410099.551 -1845.258 45.000 21771520.914 89150736.824 -1437.852 43.000
G11 20218292.344 106247839.395 437.070 44.000 20218290.375 82790516.031 340.543 39.000
G16 24614137.047 129348152.883 -2549.102 35.000 24614137.047 100790757.469 -1986.465 20.000
G18 20084844.078 105546570.480 -180.441 45.000 20084844.602 82244079.199 -140.668 39.000
G22 23999749.844 126119558.992 2465.613 38.000 23999748.195 98274979.070 1921.180 26.000
G27 24046037.734 126362774.551 -2662.340 38.000 24046039.195 98464502.613 -2074.566 39.000
G28 23831380.477 125234751.008 2417.512 40.000 23831378.719 97585516.570 1883.742 25.000
G30 21610795.938 113565496.465 1380.316 45.000 21610798.203 88492604.246 1075.527 43.000
C01 36967716.523 192500600.000 10.000 44.000 36967709.789 148853647.844 7.664 47.000
C02 38306562.961 199472321.852 20.707 39.000 38306558.727 154244635.484 16.035 44.000
C03 36909363.773 192196740.523 6.414 45.000 36909361.086 148618701.039 4.969 46.000
C04 38123486.313 198518996.797 15.398 42.000 38123483.750 153507470.684 11.938 45.000
C07 35729677.038 186053801.926 245.375 46.000 35729672.734 143868586.336 189.785 47.000
    
```

Figure 4.37 View antenna height in the RINEX file

4.5.2 Static data download for Oscar

Device preparation

- An Oscar GNSS receiver
- A mini USB cable
- A computer running RinexConverter tool

Before connecting Oscar to a computer, ensure Oscar is powered on. Use the Mini USB Cable in the package to connect Oscar to the USB port of a computer which is shown as below.



Figure 4.38 Connect Oscar to a computer

After completing the connection, the computer prompts a USB device, open it to view the files as below. Copy the folders and paste them to the computer.

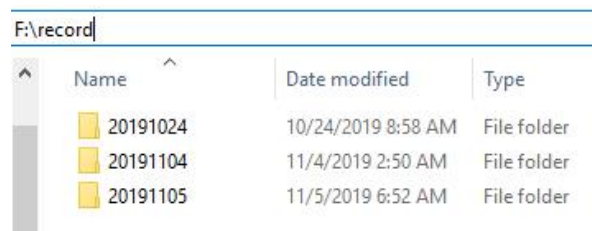

Figure 4.39 Static data recorded by Oscar

Note: When configuring static survey, if configure using buttons only, or configure using Nuwa with selecting None for Rinex format, Oscar only records trs format files. It is necessary to convert trs files to Rinex files before data post-processing.

Open Tersus Rinex Converter software, choose source file path, save path, source format, Rinex version, and click [Process] to complete the format conversion.

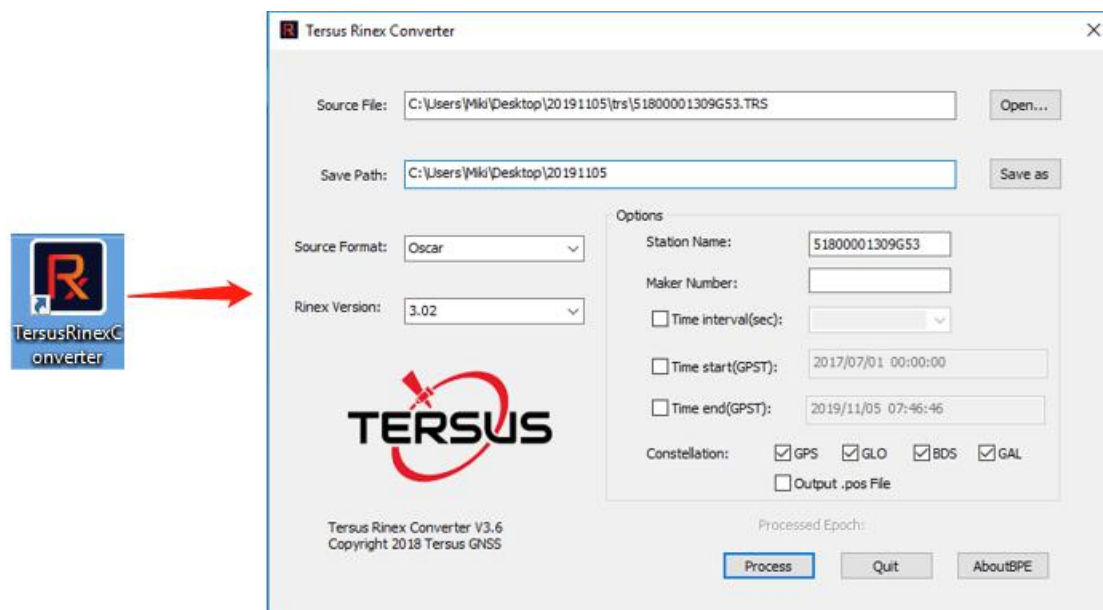

Figure 4.40 Tersus Rinex Converter interface

The Rinex files can be found in the save path as below.

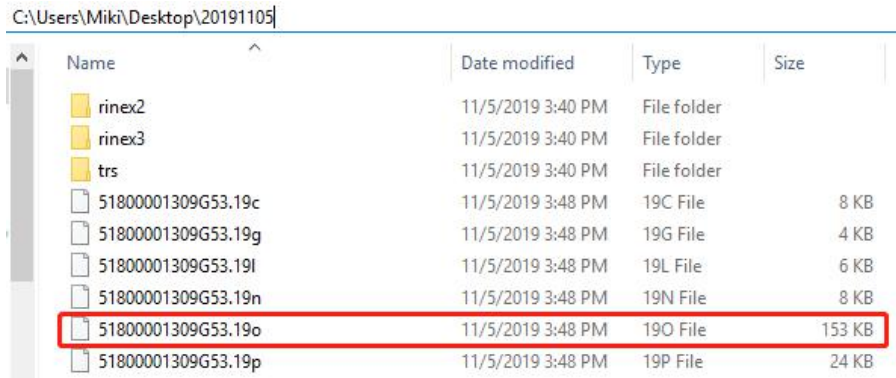

Figure 4.41 The Rinex files after conversion

4.5.3 Data post-processing

Open TERSUS Geo Office software:

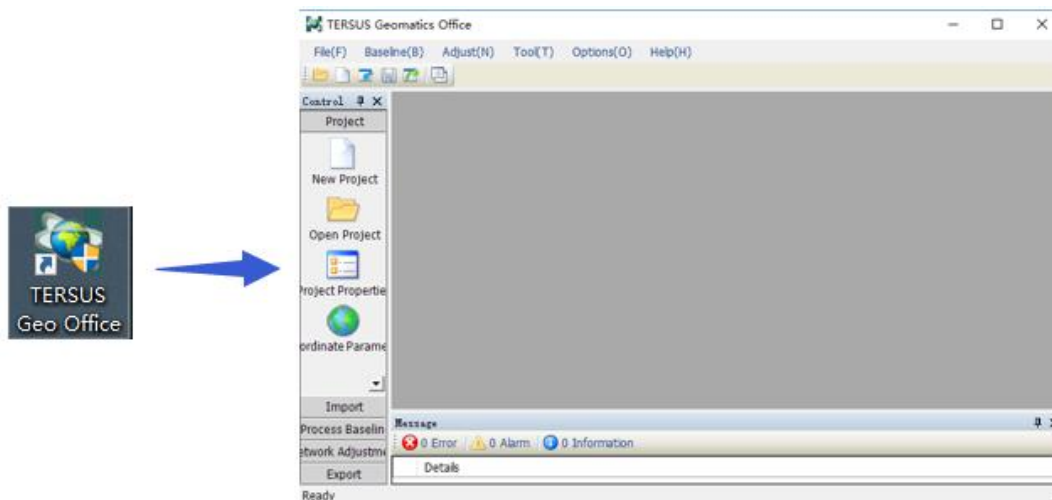

Figure 4.42 TERSUS Geomatics Office interface

After a project is created, click [Import] -> [Import Files]

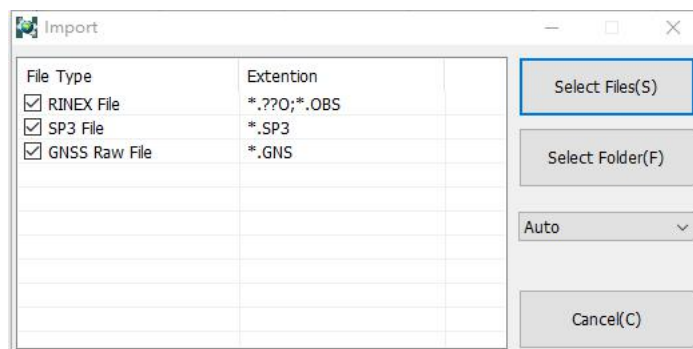
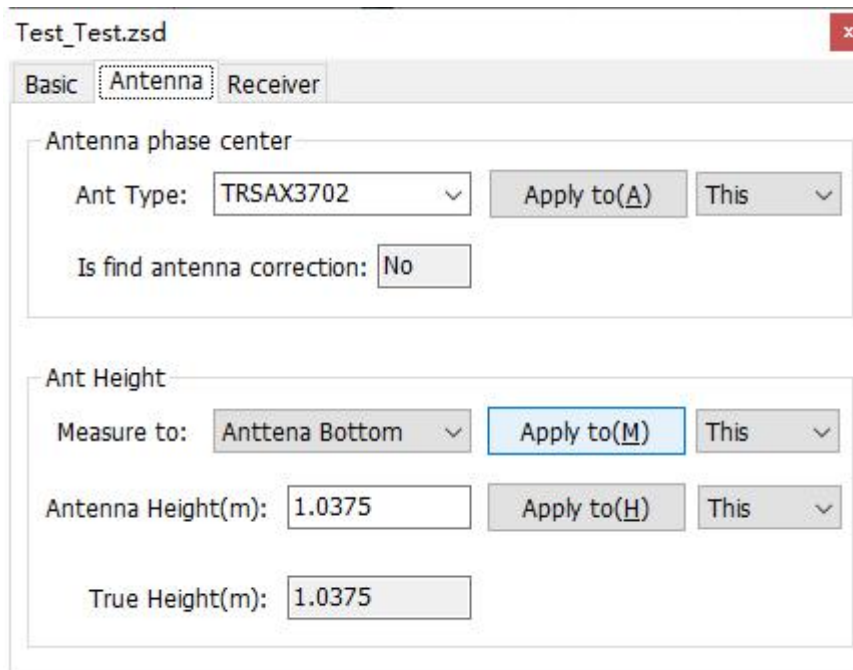

Figure 4.43 Import Files in TERSUS Geo Office

Click [Select Files] to load the Rinex files created in section 7.2.2.

After the above step of importing, the default configuration of the observation data is correct. There is no need to modify the configurations of antenna height, antenna type, and etc. The default configuration of the imported files is shown as follows.



The screenshot shows a software window titled "Test_Test.zsd" with three tabs: "Basic", "Antenna", and "Receiver". The "Antenna" tab is active. It contains two main sections: "Antenna phase center" and "Ant Height".

- Antenna phase center:**
 - Ant Type: TRSAX3702 (dropdown menu)
 - Apply to(A) button
 - This (dropdown menu)
 - Is find antenna correction: No (checkbox)
- Ant Height:**
 - Measure to: Antenna Bottom (dropdown menu)
 - Apply to(M) button (highlighted in blue)
 - This (dropdown menu)
 - Antenna Height(m): 1.0375 (text input)
 - Apply to(H) button
 - This (dropdown menu)
 - True Height(m): 1.0375 (text input)

Figure 4.44 Default configuration of the observation data

Refer to the user manual of Tersus Geo Office for more details on data post processing.

4.6 Point Correction

The point correction is to find the mathematical conversion relationship (transition parameter) between WGS84 and the local plane Cartesian coordinate system. There are three calculation types: four-parameter, height-fitting, and four-parameter + height-fitting.

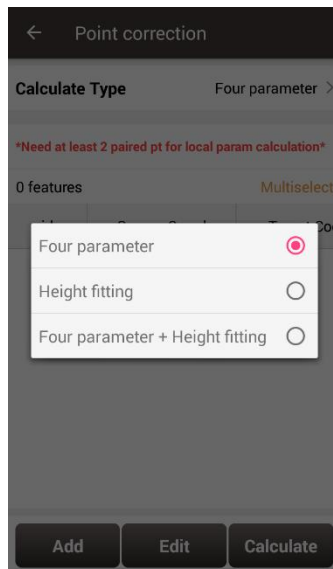

Figure 4.45 Calculation Type options

There are three methods for height-fitting: fixed difference correction, plane fitting and surface fitting.

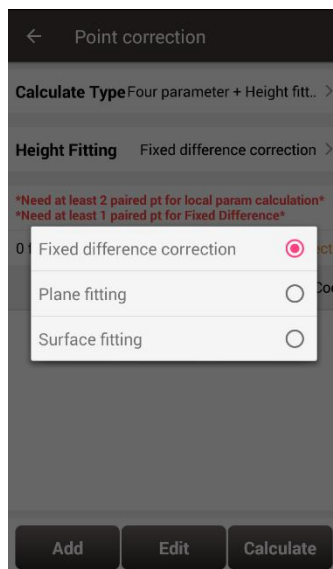

Figure 4.46 Height Fitting options

4.6.1 Four Parameter

At least two paired points are needed for Four Parameter type. Click [Add] to input the original coordinate values and the target coordinate values. Refer to section 0 about how to add points in the library.

4.6.2 Height Fitting

The number of points is different when different height fitting methods are used, the details are as follows:

Fixed Difference Correction: at least one paired point is needed.

Plane Fitting: at least three paired points are needed.

Surface Fitting: at least six paired points are needed.

Refer to section 0 about how to add points in the library.

4.6.3 Four Parameter + Height Fitting

The number of points is different when different height fitting methods are used, the details are as follows:

Fixed Difference Correction: at least two paired points for local parameter calculation and one paired point for fixed difference are needed.

Plane Fitting: at least two paired points for local parameter calculation and three paired points for plane fitting are needed.

Surface Fitting: at least two paired points for local parameter calculation and six paired points for surface fitting are needed.

Refer to section 0 about how to add points in the library.

4.6.4 Application Example

This section introduces an example of a calculation when Four Parameter + Height Fitting is selected for Calculate Type and Fixed Difference Correction is selected for Height

Fitting.

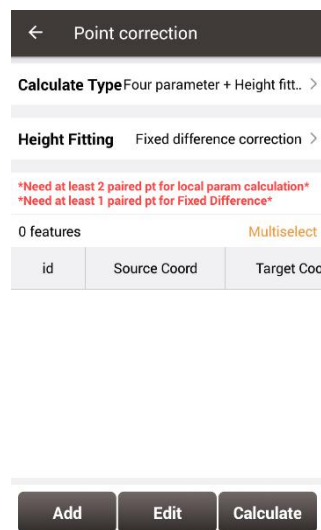

Figure 4.47 Application example for point correction

Click [Add] to add point for source coordinate and target coordinate.

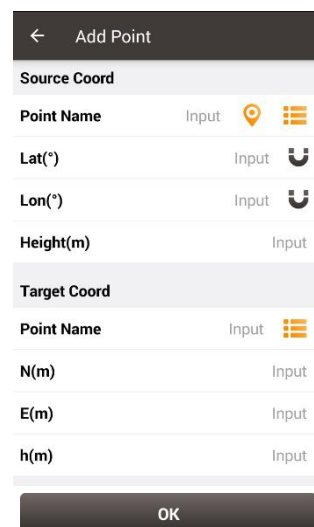





Figure 4.48 Add point for point correction

The source coordinate can be typed manually or obtained by clicking  the location icon or imported from the survey point library by clicking  the list icon.

The target coordinate can be typed manually or imported from the control point library by clicking  the list icon.

In this example, two pairs of points are type manually for calculation, which are shown below.

Figure 4.49 The 1st pair of points for calculation

 Figure 4.50 The 2nd pair of points for calculation

Click [OK] and two pairs of points are shown below.

Calculate Type Four parameter + Height fit. >

Height Fitting Fixed difference correction >

Need at least 2 paired pt for local param calculation
Need at least 1 paired pt for Fixed Difference

2 features Multiselect

id	Source Coord	Target Coord
1	B:31.198891390 L:120.716348150 H:3.9140	N:3453071.6760 E:496716.0530 H:1.9740
2	B:31.202320840 L:120.729190000 H:4.0250	N:3453451.6210 E:497939.9990 H:2.0540

Add Edit Calculate

Figure 4.51 Two pairs of points for calculation

Click [Calculate] and the data is calculated with the result shown below.



← Result:

Local Para Result:

dDX(m) : 89.3786 dDY(m) : -7.7020

Rotation Angle : 3.1718797057

Scale : 0.9999680227

Height Fitting Result:

A0: 106.76839 A1: 0.00000

A2: 0.00000 A3: 0.00000

A4: 0.00000 A5: 0.00000

Max.HRMS 0.0000 NO.: 1

Max.VRMS 0.0154 NO.: 1

Cancel Apply

Figure 4.52 Calculation Result

Click [Apply] to apply the point correction result to the current project coordinate system, and it prompts that 'Apply result successfully!'.

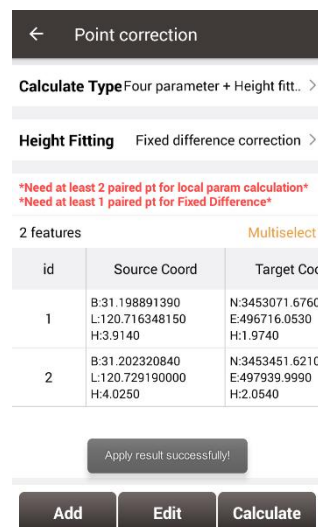

← Point correction

Calculate Type Four parameter + Height fitt. >

Height Fitting Fixed difference correction >

Need at least 2 paired pt for local param calculation

Need at least 1 paired pt for Fixed Difference

2 features Multiselect

id	Source Coord	Target Coord
1	B:31.198891390 L:120.716348150 H:3.9140	N:3453071.6760 E:496716.0530 H:1.9740
2	B:31.202320840 L:120.729190000 H:4.0250	N:3453451.6210 E:497939.9990 H:2.0540

Apply result successfully!

Add Edit Calculate

Figure 4.53 Point correction results applied to current project

Slide left of the title bar to view the values of Residual results as shown below.

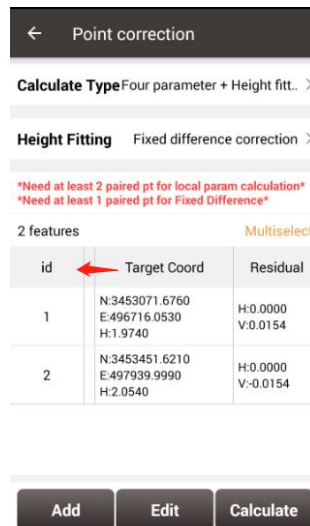

Figure 4.54 Slide left to view residual results

The results applied to the current project coordinate system can be checked in Project Property interface below.

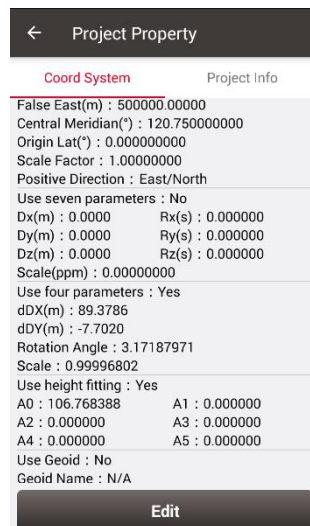

Figure 4.55 Updated project property after point correction

4.7 Survey Config

During data collection, restrictions are given to solution type and HRMS limits, hence only the data meeting the restrictions can be saved. More details are as follows:

4.7.1 Common Config

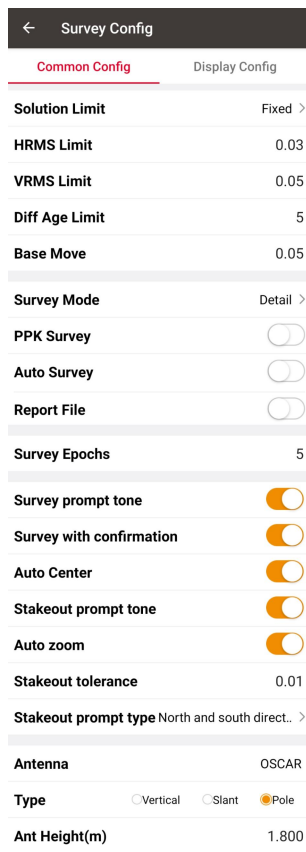

Figure 4.56 Survey Config - Detail

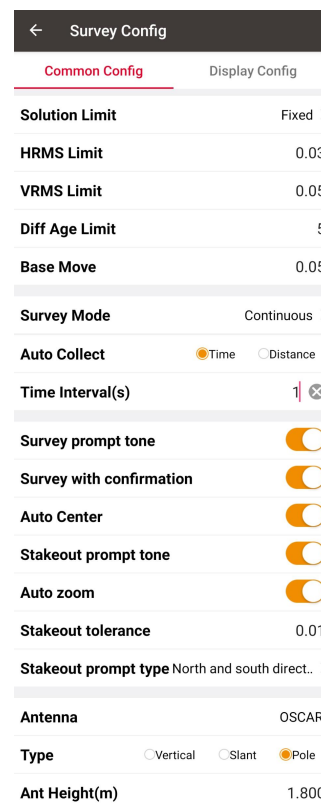

Figure 4.57 Survey Config – Continuous

[Solution Limited]: includes Single, DGPS, SBAS, Float and Fixed. The solution accuracy (from high to low) is: Fixed > Float > SBAS > DGPS > Single. Select different solution limits, the default HRMS, VRMS limit will change accordingly.

[HRMS Limited]: horizontal RMS limit. Data would not be collected if its HRMS is greater than this limit.

[VRMS Limited]: vertical RMS limit. Data would not be collected if its VRMS is greater than this limit.

[Diff Age Limited]: when the solution status is not single, no data will be collected if the current differential delay exceeds this threshold.

[Base Move]: If the base moves over this limit, there will be a new base point and the rover coordinates will be recalculated according to the new base.

[Survey Mode]: can be selected from detail, continuous and control.

1. Detail Point

[PPK Survey]: as known as Stop and Go survey mode, the high-precision position of the rover is obtained by post-processing. The steps are as follows.

- a. Start recording Rinex files for base, as the static data of the base for post-processing.
- b. Start recording Rinex files for Rover, as the kinematic data of the rover for post-processing. Otherwise, in the subsequent steps, Nuwa will prompt to start the Rinex file recording and jump to the relevant page.
- c. Enter the survey configuration interface, open the PPK survey, and set the survey epochs appropriately.
- d. Enter the survey interface, start to move the antenna. When reaching the point of interest, stop the antenna, then click the survey button. Enter the name of the point of interest and confirm the antenna value, and click OK to wait for the survey to be completed. Then continue to move the antenna to the next point of interest.
- e. When all Stop and Go measurements are completed, stop the Rinex file recording. Copy the two Rinex files to the Windows desktop and import them to the TGO post-processing software.
- f. The TGO software will automatically distinguish the static file of the base and the kinematic file of the rover, as well as the points of interest, and form a baseline. Click to process the baseline to calculate the points of interest and generate the PPK processing report.

[Auto Survey]: the auto survey can be turned on when PPK survey is on. The survey will be started automatically when reaching the point of interest and centering the bubble.

[Report File]: the report file function can be turned on, the coordinate of the survey epoch will be saved as a .txt file under project folder.

[Survey Epochs]: the survey epoch can be modified. The survey epoch can be positive integer such as 2, 3, 5 or 10. Normally set to 5s.

2. Continuous Point

[Auto Collect]: the data can be collected according to Time or Distance.

If Time is selected, ensure to input the time interval.

If Distance is selected, ensure to input the distance interval.

3. Control Point

There are three modes in control point survey, the horizontal and vertical control point, the horizontal control point and the vertical control point.

[Reset Count]: can be modified, and can be any positive integer. The default setting is 2, which means once RTK reset will be performed after starting to collect control points. If the setting is 3, twice RTK reset will be performed after starting.

[Repeat Count]: can be modified, and can be any positive integer. The default setting is 2, which means 2 measurements will be performed after each RTK reset and re-fixed.

[Survey Epochs]: can be modified, and can be any positive integer. The default value is 10, which means that 10 epochs will be observed for each measurement.

[H Diff Limit]: can be modified, as the maximum difference in plane coordinates of the measurements. During the procedure, if the difference exceeds, the procedure will be aborted.

[V Diff Limit]: can be modified, as the maximum difference in elevation coordinates of the measurements. During the procedure, if the difference exceeds, the procedure will be aborted.

[H Diff Check]: can be modified, as the maximum horizontal difference between check point and the selected control point. During the check point survey procedure, if the difference exceeds, the procedure will be aborted.

[V Diff Check]: can be modified, as the maximum vertical difference between check point and the selected control point. During the check point survey procedure, if the difference exceeds, the procedure will be aborted.

[Report File]: the report file function can be turned on, the difference between each epoch and final average result will be saved as a HTML report under project folder.

[Survey Prompt Tone]: can be enable or disabled.

[Survey with confirmation]: When it is turned on, the confirmation dialog box will pop up when a detail point is collected, check or modify the point name, code and antenna information; if it is turned off, the collected point is saved directly to the point library.

[Auto Center]: When it is turned on, the survey graphic interface will be centered to the current position every 5 seconds.

[Stakeout Prompt Tone]: can be enable or disabled.

[Auto Zoom]: When it is turned on, the stakeout graphic interface will be zoomed to the target point and the current position every 3 seconds.

[Stakeout tolerance]: the distance threshold of the stakeout tone. For example, set 0.05 means the stakeout tone beeps every 1 seconds if distance is less than 0.05m.

[Stakeout Prompt Type]: can be North and South direction or Forward and Backward.

[Antenna]: Antenna name.

[Type]: height type, can be vertical, slant or pole.

[Ant Height (m)]: value of the antenna height according the specified measuring type.

4.7.2 Display Config

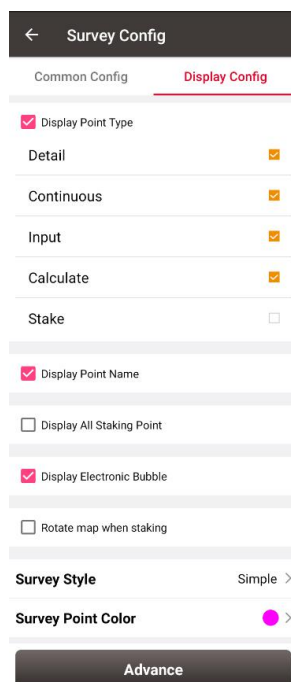

Figure 4.58 Survey Config – Display Config

Select the Display Point Type, Display Point Name, Display all staking point, Display Electronic Bubble or Rotate map when staking according to the application requirement.

Select Survey Style: Simple or Detailed.



Figure 4.59 Survey Point Color

Click [Survey Point Colour] to select a colour on the outer ring for the survey points and click the inner pie to confirm the colour.

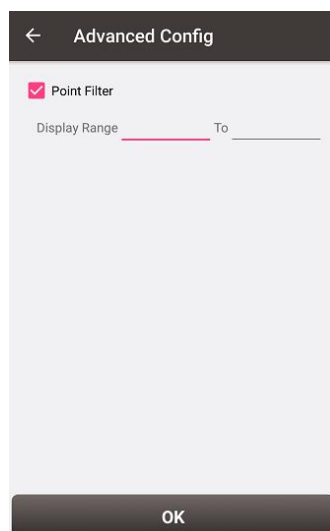

Figure 4.60 Advanced Config for Display Config

Click [Advance] to filter the displayed points.

4.8 Base Shift

In 'Auto Start' mode for base station, if the base is moved, re-erected or restarted at an unknown point, base shift should be performed to ensure the points collected by the current base station is consistent with that before the base is moved or powered off.

Briefly, find a known point, measure the coordinates of this point, then use this point to

calculate the offset of the base shift, apply the base shift to all the survey points under the current base coordinates to make the reference coordinate system of the base remains the same as the previous base station.

The detailed steps are as follows:

Click [Base Shift] to enter the following interface, Figure 4.52 shows the calculation result for the base shift; Figure 4.53 shows the source of the base shift calculation. Click the list icon on the right of GNSS Point to select a survey point which is measured at the known point and click the list icon on the right of Known Point to select a known point in the control point library (details of control point refers to section 2.4 Point). Click [Calculate] and the base shift is calculated automatically. Click [Apply] to apply the base shift to all the points surveyed and to be surveyed under the current base station.

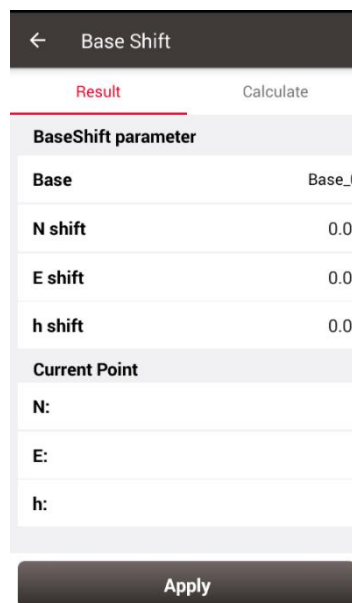

Figure 4.61 Base Shift interface – 1

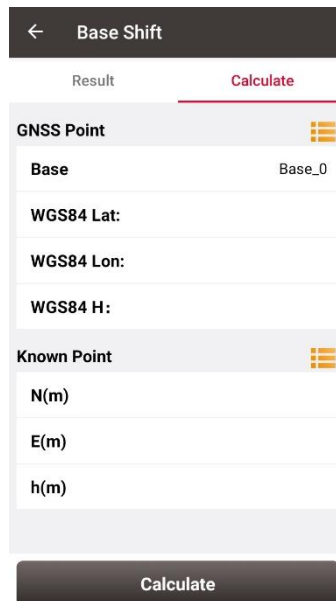



Figure 4.62 Base Shift interface – 2

At this time, select the base point in the survey point library to view the details. It can be found that the current NEh shift amount is recorded in the base point information, and the NEh coordinates of all the survey points under this base station change accordingly.

If you need to reset (cancel) the base shift, just enter [base shift], and manually modify the three parameters of north shift, east shift and height shift to 0. At this time, return to the survey point library to view the details of the base point. The NEh shift amount in the base point information is automatically changed to 0, and all survey points NEh coordinates under the base station are restored to the coordinates before the base shift.

4.9 Road Stakeout

According to the digital designed road created in the road management module, after the software is connected to the high-precision positioning GNSS receiver, enter the road stakeout interface to stake out the designed road stake points and other feature points.

Click [Survey] -> [Road Stakeout], click the  icon to select a road file, the road is drew on the map after the road file is loaded, and then you can start the stakeout. It may take

some time for the software to load the newly-built road or modified road for the first time. Once the loading is completed, this road is selected again for stakeout without waiting.

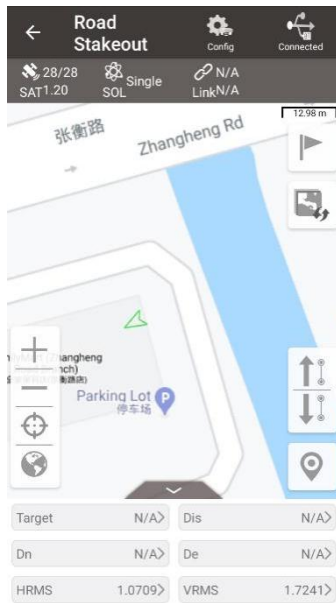

Figure 4.63 Road stakeout interface

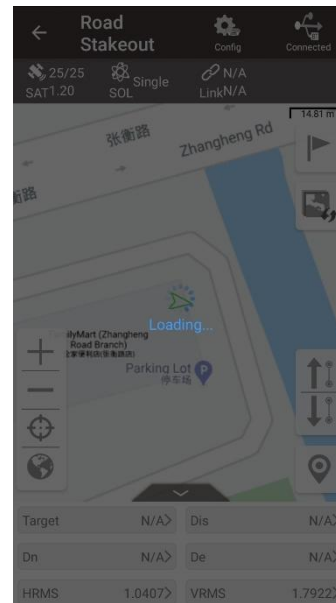

Figure 4.64 Road data is loading

Alignment Stakeout

After the loading is completed, select the type as Interval. It is divided into the options of by interval and by nearby. By interval means starting from the starting mileage point, stake out step by interval according to the set interval. The mileage value of the nearest point on the road to the current position will be obtained after clicking the position icon, so that it is convenient to start the road stakeout from that point immediately. Stakeout by nearby will calculate the nearest point on the road to the current position as the target point at any time, and with the current position moving, the mileage and offset of the corresponding point on the road will change. Staking to the middle pile, left pile and right pile are allowed in alignment stakeout. The coordinates of the middle pile are calculated according to the alignment and vertical profile, when cross section, super elevation and widening are added to the calculation of the coordinates of the left or right pile. Then follow the software instructions to move the high-precision GNSS receiver to the design point to complete the stakeout.

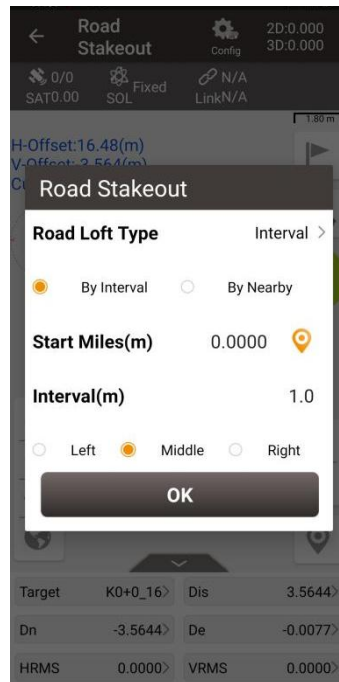

Figure 4.65 Road stakeout setting

Cross-section Point Survey

After the loading is completed, select the type as Cross. The cross-section point survey will start from the cross-section at the starting mileage. When the current mileage cross section point survey is completed, click on the previous or next to jump to another mileage according to the set interval. The mileage value of the nearest point on the road to the current position will be obtained after clicking the position icon, so that it is convenient to start cross-section point survey from the mileage at that point immediately. In the process of cross-section point survey, the software draws the cross-section at the current mileage and, as the current position moves, the software shows the H-offset, V-offset and Cut or Fill values according to the cross-section.

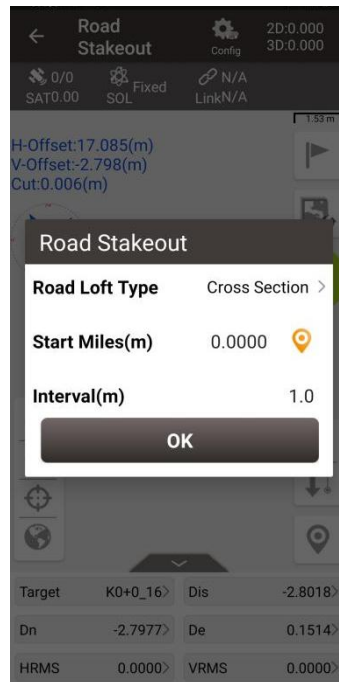

Figure 4.66 Road stakeout setting

4.10 Area Stakeout

According to the 3dface data in the DXF file, after the software is connected to the high-precision positioning GNSS receiver and enters within the 3D surface area, the software interpolates the design height of the current plane position based on the 3dface data, and indicates the fill or cut value.

Click [Survey] -> [Area Stakeout], then select a DXF file containing 3dface data. Click and load the DXF file, as shown in the figure below.

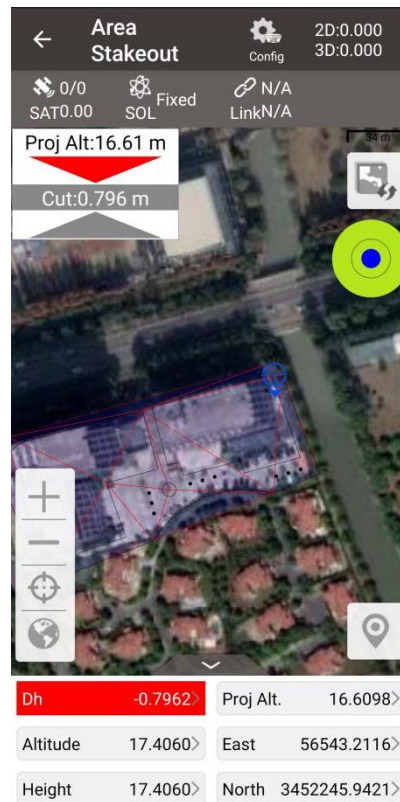



Figure 4.67 Area stakeout

When the position is within the 3D surface area, the software automatically interpolates the design height value based on the 3dsurface data, and calculates the cut / fill value by subtracting the current height from the design height. When the design height is smaller than the current height, the height deviation is negative and it needs to be cut, the indication is red. When the design height is larger than the current height, the height deviation is positive and it needs to be filled, the indication is blue.

If you need to change the DXF file for area stakeout, click the  button and select another DXF file in /TersusSurvey/Maps.

4.11 CAD Stakeout



CAD stakeout module is used to import CAD files in DXF or DWG format and directly select points and lines on CAD drawings for stakeout.

Click [Survey] -> [CAD Stakeout], select a CAD file in DXF format or DWG format, as shown in the figure below. If there is a recently opened CAD file, it will be displayed in Recent files and can be opened directly by clicking on it.



Figure 4.68 Select CAD file

After opening the CAD file, it jumps to the main CAD stakeout interface, the CAD drawing is loaded and displayed, as shown below. Use the point selection tool  to select the point on the drawing to stake the point. Click point or line on the drawing directly and then

click  or  to stake the point or the line.

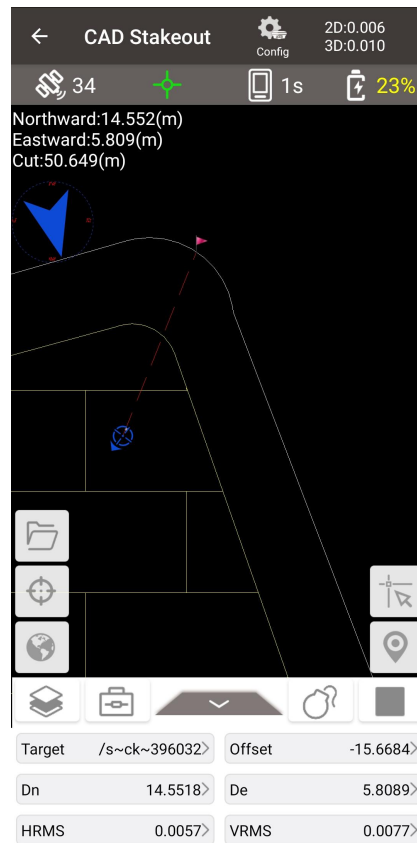





Figure 4.69 CAD stakeout

[]: Zoom by current position.

[]: Zoom all.

[]: Point selection, click on it and the point selection tool will appear on the main screen, press the tool and move to capture the POI, then the point stakeout starts.

[]: Stake point collect, stake the POI and the stakeout ends.

[]: Layer management, control the display, locking and freezing of different layers.

[]: Tool set.

[]: Distance measurement, select two points on the drawing and calculate the distance.

[]: Area measurement, select points on the drawing and calculate the area and perimeter.

[]: Find, enter text to search and locate the text.

[]: Switch the background color, which is currently allowed to be black or white.

[]: Explode, select a block or polyline and explode it.

[]: Default state, waiting for the point or line to be selected.

[]: Point stakeout, click the button to start staking the selected point.

[]: Line stakeout, click the button to start staking the selected line.

[]: Stakeout stop, click it to return to the default state.

In the point stakeout interface,

- The red flag indicates the location of the stakeout point.
- The red dotted line is the connection between the current point and the point to be staked.
- The small blue arrow is the point to be staked.
- The small blue arrow pointing towards the surveyor heading.
- The big blue arrow prompts the surveyor that the point to be staked is in the front/rear/left/right position.
- The blue number shows the distance from the point to be staked in different directions.

5. Tools

- Area Perimeter
- Azimuth Distance
- Offset Point
- Rotation Point
- Two Points Intersection
- Four Points Intersection
- Intersection Angle
- Earthwork
- Angular Bisector

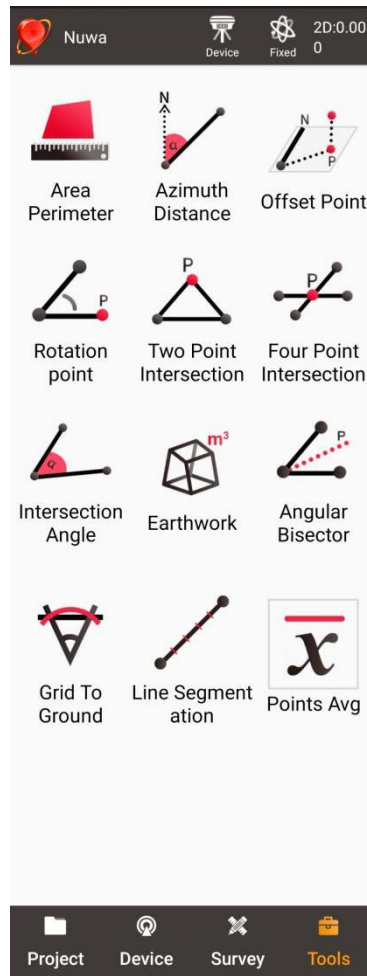

Figure 5.1 Functions under Tools

5.1 Area Perimeter

This tool is used to calculate area and perimeter. The points can be imported from the point library by clicking the list icon on the upper right corner. The unit is meter for perimeter and square meter for area.

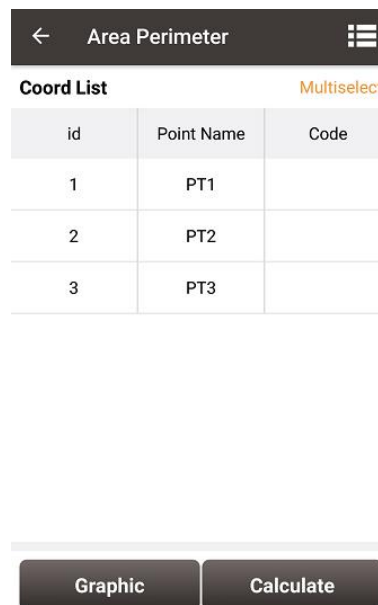

Figure 5.2 Area Perimeter interface

[Graphic]: shows the closed polygon formed by the points.

[Calculate]: calculates the area and perimeter of the closed polygon.

[Multiselect]: enters point edit interface to inverse or delete.

Note: The calculation results are all plane results (point elevation does not participate in the calculation). It is suitable for all sections in this chapter except section 5.3 Offset Point.

5.2 Azimuth Distance

There are two kinds of azimuth distance calculation: point to point, and point to line. The points can be imported from the point library.

5.2.1 Point to Point Distance

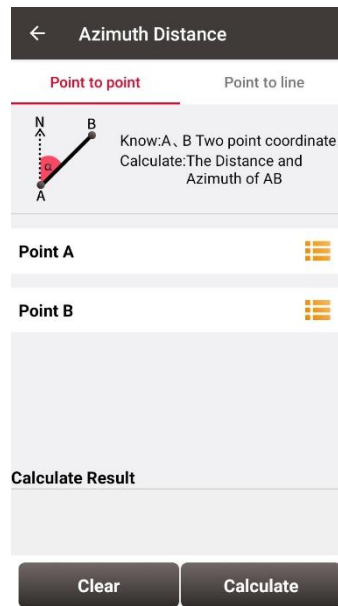

Figure 5.3 Azimuth Distance – Point to Point

Import point A and point B from the point library.

[Calculate]: calculate the distance between the two points and the azimuth.

[Clear]: clear the result.

5.2.2 Point to Line Distance

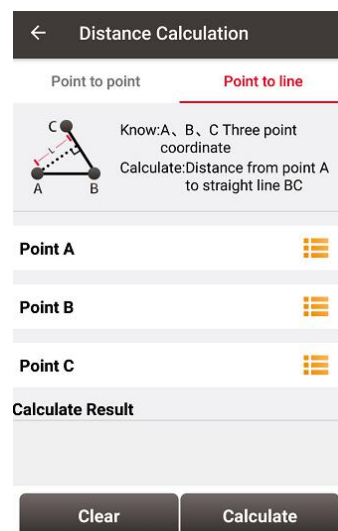

Figure 5.4 Azimuth Distance – Point to Line

Import points from the library to calculate the distance from point A to line BC.

[Calculate]: calculate the distance.

[Clear]: clear the result.

5.3 Offset Point

5.3.1 Offset point

Given the azimuth of point A & P, AP's horizontal length L and height H, calculate the coordinate of P. The steps are as follows:

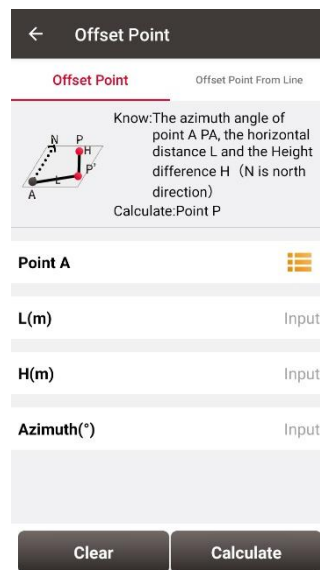

Figure 5.5 Offset Point interface

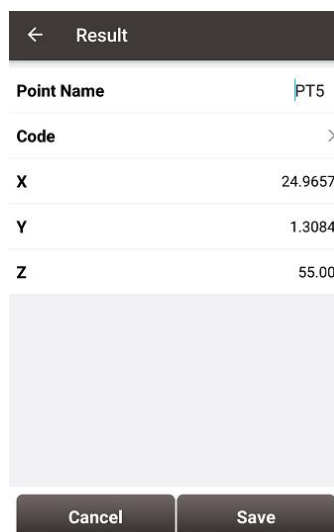

Figure 5.6 Offset Point calculation result

[Calculate]: calculate the coordinate of point P.

[Clear]: clear the current result.

5.3.2 Offset point from line

Given the coordinates of point A and B, the distance L from B to C, the offset D from AB line and the height difference H, calculate the coordinate of point P.

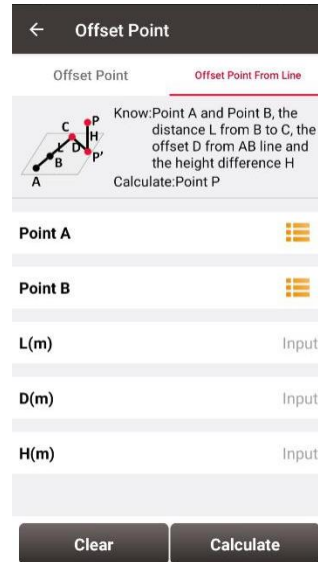

← Offset Point

Offset Point Offset Point From Line

Know: Point A and Point B, the distance L from B to C, the offset D from AB line and the height difference H
Calculate: Point P

Point A ☰

Point B ☰

L(m) Input

D(m) Input

H(m) Input

Clear Calculate

Figure 5.7 Offset point from line

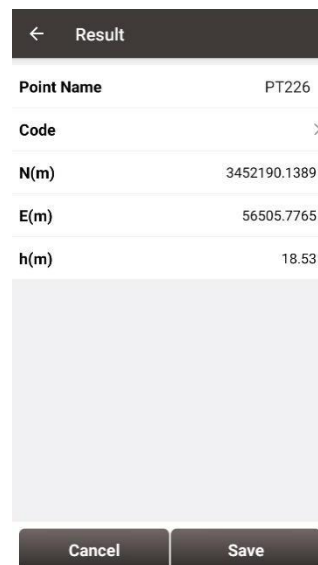

← Result

Point Name PT226

Code >

N(m) 3452190.1389

E(m) 56505.7765

h(m) 18.53

Cancel Save

Figure 5.8 Offset point from line calculation result

[Calculate]: calculate the coordinate of point P.

[Clear]: clear the current result.

5.4 Rotation Point

Given the coordinates of point A, B and the rotation angle (clockwise), calculate the coordinate of point B after rotation.

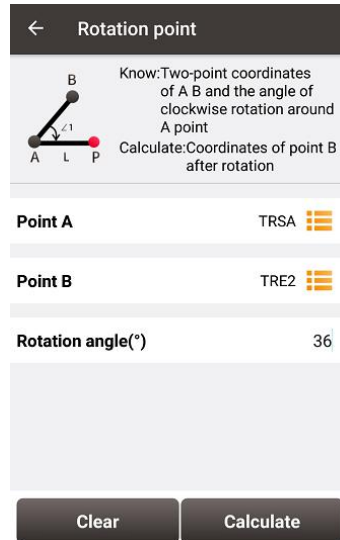

Figure 5.9 Rotation Point interface

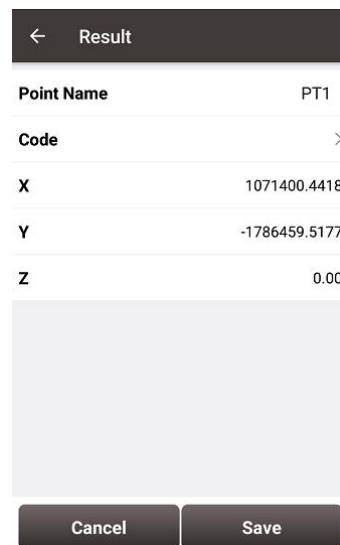

Figure 5.10 Rotation Point Calculation result

[Calculate]: calculate the coordinate of point B after rotation.

[Clear]: clear the result.

5.5 Two Points Intersection

There are two types of models listed below:

- Model 1: Given the coordinates of point A and B, the angle α between line AB and AP, the angle β between line AB and PB, calculate the coordinate of point P.
- Model 2: Given the coordinates of point A and B, the length of line AP and BP, calculate the coordinate of point P.

Figure 5.11 Two Point Intersection – Angle

Figure 5.12 Two Point Intersection – Distance

[Calculate]: calculate the coordinate of the intersection P.

[Clear]: clear the result.

5.6 Four Points Intersection

Given the coordinates of point A, B, C and D, calculate the coordinate of the intersection point P between line AB and line CD.

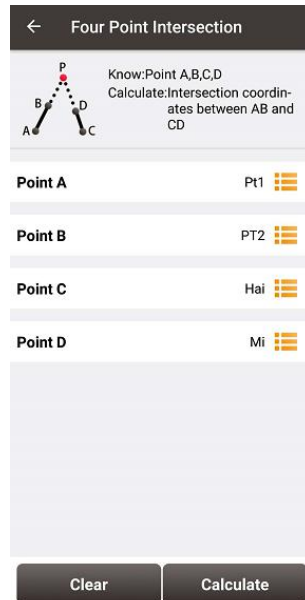

Figure 5.13 Four Point Intersection interface

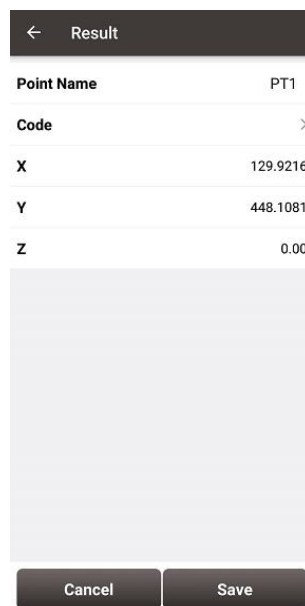

Figure 5.14 Four Point Intersection result

[Calculate]: calculate the coordinate of the intersection P.

[Clear]: clear the result.

5.7 Intersection Angle

Given the coordinates of point A, B and C, calculate the angle $\angle ABC$



Figure 5.15 Intersection Angle calculation

[Calculate]: calculate the angle $\angle ABC$.

[Clear]: clear the result.

5.8 Earthwork

The detailed earthwork process is as below.

- (1) Select all surface points to be calculated for earthwork from the point library, and add them to the list of All Points.

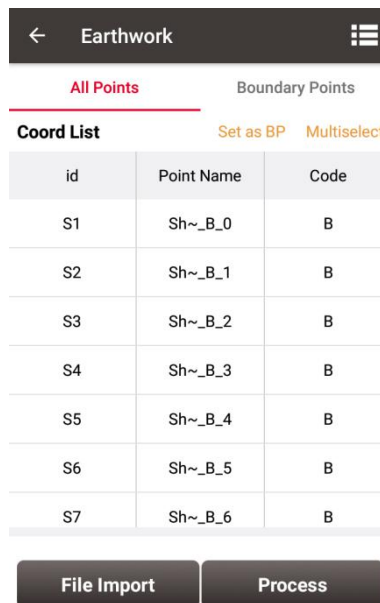

Figure 5.16 Select all surface points to be calculated

- (2) Select the boundary points from the list of All Points, and set them as BP to add them to the list of Boundary Points. Sort the boundary points in order by moving up and down.

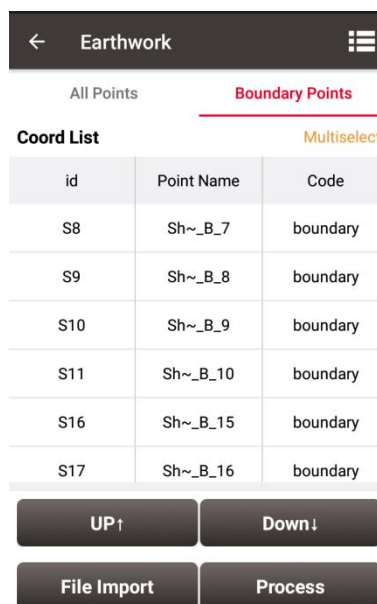

Figure 5.17 Select the boundary points

- (3) Click [Process], the software will first ask the path to save the surface file to be generated.

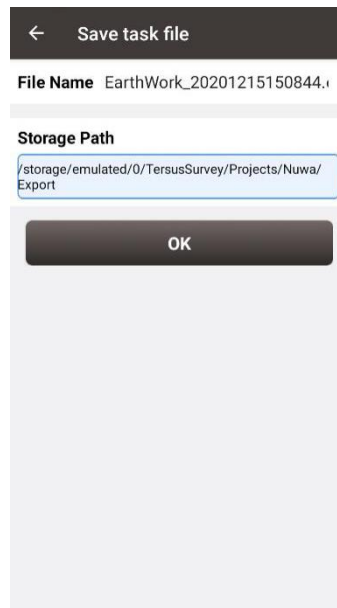

Figure 5.18 File name and storage path for the earthwork

- (4) The software will generate a triangulation network from the selected surface points through specific rules.
- (5) Input the reference height, the software will calculate the volume formed between each triangulation network and the reference height, and calculate the fill and excavation amount in total.



Figure 5.19 Earthwork calculation result

5.9 Angular Bisector

Given the coordinates of point A, B and C, and the length of BP in which P is a point on the angular bisector of the angle $\angle ABC$, calculate the coordinate of point P.

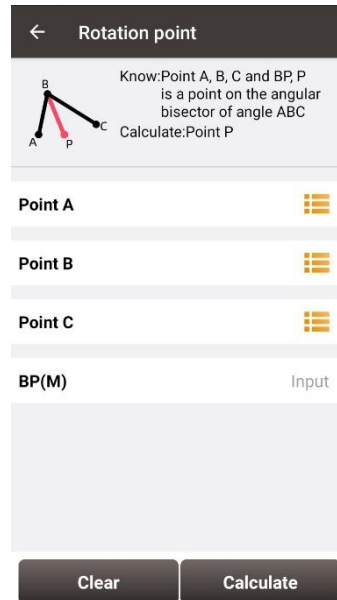

The screenshot shows a mobile application interface titled "Rotation point". At the top left is a back arrow. The main content area contains a diagram of a triangle with vertices A, B, and C. Point P is located on the angle bisector of angle B. Text next to the diagram reads: "Know: Point A, B, C and BP, P is a point on the angular bisector of angle ABC Calculate: Point P". Below the diagram are four input fields: "Point A", "Point B", "Point C", and "BP(M)". Each of the first three fields has a menu icon to its right. The "BP(M)" field has an "Input" label to its right. At the bottom of the screen are two buttons: "Clear" and "Calculate".

Figure 5.20 Intersection Angle calculation

[Calculate]: calculate the coordinate of point P.

[Clear]: clear the result.

5.10 Grid to Ground

Since the GNSS measurement gets the plane grid coordinates by projection, there are deformation caused by the projection and the deformation caused by the curvature of the earth. If the length between points A and B measured by GNSS receiver will be different from the length between points A and B measured by optical instruments such as total station, so when the measurement area is large, it is necessary to consider this tool to realize the correction of grid coordinates to ground coordinates.

By selecting a point as the datum and clicking Calculate, the software will calculate the correction factor based on the location of the datum, and then click Apply to apply the correction factor to the project. If you find that the software calculates the scale factor incorrectly, or if you learn the correct scale factor in some other form, you can modify it

manually.

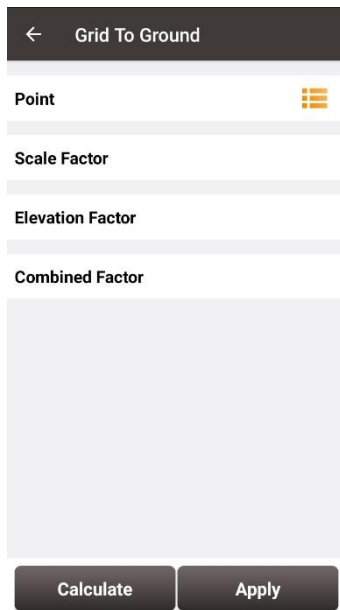

Figure 5.21 Grid to Ground interface

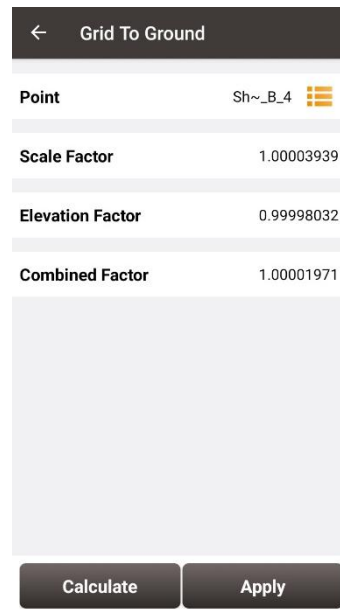

Figure 5.22 Calculate the correction factors

After clicking Apply, return to the point library to see, the point details of the measured points in the point library add the display of ground N, E and h coordinates, and the distance between these points and the datum under the ground coordinates are worth to reformat.

← Detail	
Name	Sh--B_4 Code B
N(feet)	11326083.4886
E(feet)	185454.8659
h(feet)	54.4495
Combined Factor	1.00001971
Ground N	11326083.4886
Ground E	185454.8659
Ground h	54.4495
Lat	31.189458683N
Lon	122.593036298E
Height(feet)	411.1535
ECEF-X(feet)	-9651583.7983
ECEF-Y(feet)	15095802.9184
ECEF-Z(feet)	10774100.1364
Lat(LOCAL)	31.189437106N
Lon(LOCAL)	122.593036298E
H(LOCAL)(feet)	54.4494
Base	
Base Lat84	0.000000000N
Base Lon84	0.000000000E
Base Alt84(feet)	0.0000
Base Ant.Height	0.0000
Solution States	None >
Collection End	2020-12-15 15:08:28
Coord Type	NEH >
DOP(P/H/V)	0.0/0.0/0.0
RMS(HRMS/VRMS)	0.0000/0.0000
Std(Lat/Lon)	0.0000/0.0000
Ant Height(feet)	0.0000
Photo	
OK	

Figure 5.23 Point detail after applying the calculation

5.11 Line Segmentation

Given AB line, calculate the equivalent points or equidistant points on line AB.



Figure 5.24 Line Segmentation

[Segment method]: By number of segments or by interval length

[Code]: Calculation points code

[First Point Name]: Calculation points name and naming rule

[Calculate]: Calculate points

[Save]: Save the calculation points to the point library

5.12 Points Avg

This tool is used to calculate the average points. Points can be imported from the point library by clicking the list icon on the upper right corner or by clicking the Add button. Click the Calculate button to calculate the average result for all selected points and display the difference between the selected points and the average result.

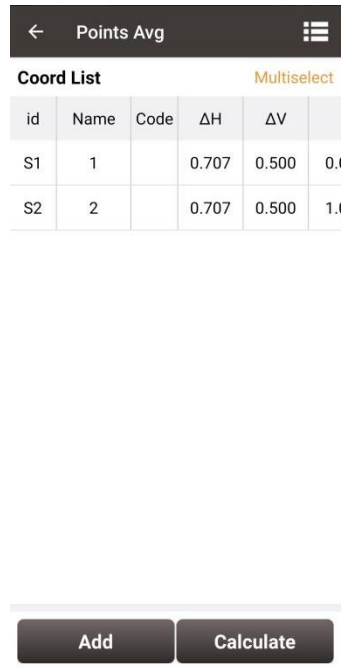

Figure 5.25 Points Avg

6. TC20 Controller and application

6.1 Overview of TC20 Controller

The Tersus TC20 Controller is a rugged smart phone with design of 4.3" touch screen and an alphanumerical keypad. Equipped with powerful processor, it is perfect to adapt with Tersus Survey software. With professional IP67 rating, it is robust and reliable for harsh operating conditions.

Features:

- Rugged smart phone 4.3" display
- 4G GSM unlocked Android 6.0
- Quad-Core 1.3GHz CPU
- 2GB RAM + 16GB ROM
- 8 MP Auto Focus camera
- IP67 certified grade, water/shock/dust proof
- 6500 mAh battery
- A-GPS supported
- Wi-Fi, Bluetooth, NFC
- Two color options: red and yellow

Note: Although the TC20 controller uses chemical and impact resistant materials, precision instruments require careful use and maintenance and should be kept as dry as possible. In order to improve the stability and life cycle of the TC20 controller, avoid exposing the TC20 controller to extreme environments such as moisture, high temperatures, low temperatures, corrosive liquids or gases.



TC20 must be in the specified temperature range $-20^{\circ}\text{C} \sim 55^{\circ}\text{C}$ when used and stored.

6.2 Outlook of TC20 Controller

Power on: Press and hold the power button for 3 seconds

Power off: Press and hold the power button for 3 seconds, select 'power off' in the menu option.



Figure 6.1 Four sides of TC20 controller

Menu Key: Select to show the available menu in current screen.

Home Key: Return to home screen. To view recent application, press and hold the home key.

Back Key: Return to previous screen.

Volume Key: Adjust the volume of the ringtone.

Reset Key: Shut down the phone when the device is abnormal.

Camera key: Short press to enter camera in home screen. Long press it to open torch.

6.3 Accessories of TC20 Controller

TC20 Lithium Battery (3.7V/6500mAh)



Figure 6.2 TC20 Lithium battery

TC20 Charger Adapter (5V/1A) with one USB port



Figure 6.3 TC20 Charger Adapter



Figure 6.4 TC20 Charger Adapter Plugs

A: American, B: British, C: Chinese, E: European, N: Australian

Put the plug in in the back of the adapter to assemble the TC20 Charger.

The hand strap below is for easy handling of TC20 controller.



Figure 6.5 TC20 Controller hand strap

The stylus pen below is for easy touch of screen on TC20 controller.



Figure 6.6 Stylus Pen for TC20

The mini USB cable below is to charge TC20 controller or transfer files between TC20 controller and a computer.



Figure 6.7 Mini USB cable

6.4 General Operations

6.4.1 Insert SIM card and Micro SD card

1. **Remove the back cover:** Loosen the screws on the back side - to rotate the screws anti-clockwise until open the back cover as shown in Figure 6.8.



Figure 6.8 Remove the back cover

2. **Take off the back cover:** Remove the back cover by lifting it up from the bottom part as shown in Figure 6.9 and take out the battery.



Figure 6.9 Take off the back cover

3. **Put the SIM Card in the holder:** Put the SIM card into the slot touching the SIM contacts of the phone as shown in Figure 6.10.



Figure 6.10 Put the SIM card in the holder

4. **Insert Micro SD card:** Open Micro SD card holder and insert Micro SD card into the slot, then close Micro SD card holder as shown in Figure 6.11.



Figure 6.11 Insert Micro SD card

5. **Insert the back cover:** Insert the back cover and rotate screws clockwise to lock the back cover as shown in Figure 6.12.



Figure 6.12 Insert the back cover

Note: Please power off the phone before plug in or pull out the SIM card.

6.4.2 Micro SD card

1. Connect USB, turn on USB storage.

It automatically pops up USB connected interface after connecting USB, and then click [Transfer Files] to turn on USB storage to use the files in the Micro-SD card.

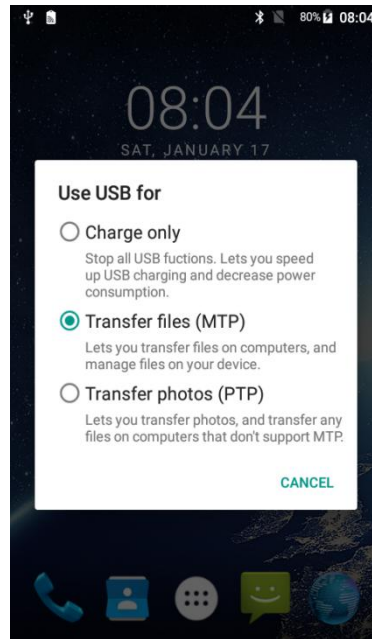

Figure 6.13 Select USB function

6.4.3 Using of Touch Screen

Single Click: To select an icon. For example, click dial to open the keypad which will be displayed on the screen.

Double Click: To zoom-in or zoom-out. For example, to zoom-in or out of a photo, click twice when viewing a photo or browsing on the internet.

Hold: Click and hold the screen, icon or input box to get more operation options.

- 1) Long-Time Click a picture in the gallery list interface, the status bar prompts to select a picture, you select to share or delete.
- 2) Long-Time Click the blanks of home screen to add home screen shortcut.
- 3) Long-Time Click the blanks of home screen wallpaper sources can be selected.

Drag the screen: You can drag the screen to view more applications which are not displayed in one screen.

Stylus Pen: you can use stylus pen for the touch screen after turning on the function via Settings -> Accessibility -> Handwriting Pen.

7. Technical Appendix

7.1 Quick Start

1. Create a new project

Go to [Project] -> [Project], click [New], input the project name, select a CRS or edit with a template CRS, click [OK] to create a project.

2. Connect a device

Go to [Device] -> [Connect], select the device type, connect type, connect config and antenna type, and click [Connect]. Click  in the status bar can also connect to the device.

3. Configure the base and the rover

A base transmits RTK corrections to a radio or to network. The position of the base must be input manually or auto start. Nuwa supports RTK uploading to a NTRIP host, which brings convenience for a number of applications.

A rover receives RTK corrections from a radio or from network. NTRIP, TCP and TCS protocols are supported if corrections are received from network.

All the configuration can be managed, such as created, edited and deleted in Nuwa App. A device can be configured to work as a base or as a rover.

4. Point Correction and Base Shift

The point correction is to find the mathematical conversion relationship (transition parameter) between WGS84 and the local plane Cartesian coordinate system. There are three calculation types: four-parameter, height-fitting, and four-parameter + height-fitting.

There are three methods for height fitting: Fixed Difference Correction, Plane Fitting and Surface Fitting.

In Auto Start mode, if a base is moved, re-installed or powered off, Base Shift is necessary to make the points have the same coordinates before and after the change. Main steps: Go to [Survey] -> [Base Shift], select GNSS points and known points, click [Calculate], the offsets parameters are calculated automatically. The user can apply the parameters on the points to be surveyed. Base Shift also influence coordinates value of other points with this base.

Steps 5 – 8 are action points in fields, select one or more in fields.

5. Survey

Go to [Survey] -> [Survey] to enter survey interface, which can be in text mode or drawing mode. The main difference between the two modes is whether the drawing is displayed.

The configuration refers to section 4.7.1 Common Config for more details.

Two collection modes: Auto Collect and Manual Collect, refer to section 4.1 Survey for details. All the detailed information about the survey points can be checked in the survey point library.

6. Point Stakeout

Go to [Survey] -> [Point Stakeout] to enter point stakeout interface. Stakeout points must be saved in the stakeout point library before. Select the points to be stakeout and find the target point according to the prompt information by Nuwa, refer to section 4.2 Point Stakeout for details.

7. Line Stakeout

Go to [Survey] -> [Line Stakeout] to enter line stakeout interface. Stakeout lines must be saved in the stakeout line library. Select the lines to be stakeout and find all the points on the target line according to the prompt information by Nuwa, refer to section 4.3 Line Stakeout for details.

8. Static Survey

Go to [Survey] -> [Static Survey] to enter static survey interface. Select the parameters, such as interval, cut off angle, antenna parameters and click [Start], refer to section 4.5 Static Survey for details.

9. Export

Go to [Project] -> [Export] to enter export interface. The supporting file formats include: csv, kml, shp, dxf, html and kml. The data to be exported can be filtered by point type and collection time. Click [Export] after all the options are filled.

10. Import

Go to [Project] -> [Import] to enter import interface, which can be divided into Coordinate Import and Other Import.

Coordinate import is to import points in a .csv file or .dat file, mainly to import points to a library.

Other import is to import the DXF or SHP files for the background. Click [File Path] to select the file directory.

7.2 Issues and Solutions

Issues about David GNSS Receiver

1. Bluetooth / USB cannot be connected with David.

Solutions:

- (1) Check if other devices have connected to Bluetooth (COMM1-Bluetooth module only supports Android phones);
- (2) Check if the Bluetooth model matches the David GNSS receiver, the David-R model matches the BT420R model of Bluetooth module, and the David model matches the BT420A model of Bluetooth module;
- (3) Check if the David GNSS receiver is powered on normally. If the receiver's LED is bright but cannot search for the Bluetooth name, please delete the matched Bluetooth in the phone and search again. If you still cannot find the Bluetooth device name, please contact the supplier for assistance;
- (4) Reconnect USB and allow USB device to connect when USB cannot be connected;
- (5) If the radio base station mode is used, check the power supply. At this time, only the 12V battery can be used for power supply. Do not use 5V power bank for power supply.

2. David GNSS receiver cannot be located.

Solutions:

- (1) Check if the GNSS antenna is properly connected;
- (2) Check if the GNSS antenna cable and connector are intact or damaged.
- (3) Ensure that the GNSS antenna is placed in an open outdoor environment;
- (4) Check if David's LED light is in normal startup state.

3. The rover with 2W radio kit cannot obtain a fixed solution.

Solutions:

- (1) Check if the radio 'T/R' LED is in the receiving state with blue light. If it is not in the receiving state, press and hold the 'CHAN' and 'PWR' buttons for about 1 second to switch to the receiving state.

(2) Check whether the number of channels and the transmission protocol of the rover are consistent with that of the base radio;

(3) Check whether the baud rate of the serial port of the 2W radio and the base radio is normal. The baud rate of the serial port of the 2W radio and the 30W radio is 38400bps, and the baud rate of the serial port of the 1W radio is 115200bps.

4. The rover network mode cannot obtain a fixed solution.

Solutions:

(1) Check if the network of the rover is normal, and whether the controller (an android device) can connect to the network normally;

(2) Check if the rover's user name and password are correct, pay attention to case sensitivity, and there is no '@' character at the beginning of the rover's password;

(3) Check if the rover's MountPoint is consistent with that of the base. It is recommended to use the default base serial number as MountPoint;

(4) Check if the base has sent corrections data normally.

5. The base radio constantly restarts.

Solutions:

(1) In the base radio mode, only 12V battery can be used for power supply, and 5V power bank cannot be used for power supply;

(2) Check if the battery is low power or insufficient voltage.

6. The local coordinate deviation of the rover is large.

Solutions:

(1) Check if the coordinate system of the project in Nuwa application is configured correctly;

(2) If point correction or parameter calculation is not performed, the base needs to be configured by manual start, and the known point coordinates of the base configuration should be consistent with the known point of the actual installation;

(3) If point correction or parameter calculation is performed, check whether the coordinate

of the control point is incorrectly entered, whether the coordinate deviation of the control point and the distribution of the control point is uniform, and whether the scale is close to 1 in the parameter calculation result.

7. It prompts that the coordinate deviation is large when configuring base.

Solutions:

- (1) If the input is WGS84 coordinates, check whether the input coordinates are the same point, and the coordinate difference cannot be greater than 30m;
- (2) If the input is local coordinates, check whether the configured coordinate system is consistent with the coordinates that need to be input.

8. The time for the rover to get a fixed solution is too long.

Solutions:

- (1) Check the number of satellites for the rover, the satellite distribution (whether the occlusion is serious), and the satellite signal-to-noise ratio (whether the maximum signal-to-noise ratio is greater than 50);
- (2) Check if the antenna connection is loose;
- (3) Check whether the correction data of the base is normal, and whether it includes correction data of GPS, GLONASS, and BeiDou systems.

Issues about Oscar GNSS Receiver

1. Oscar GNSS Receiver cannot search satellite signals.

Solutions:

- (1) Change test environment, restart the receiver in an open space;
- (2) Reset the GNSS module by holding the FN button and pressing the power button five times.

2. The internal radio cannot transmit data

Solutions:

- (1) Check whether the receiver can search satellite signals normally;
- (2) Check whether the whip antenna is properly installed;
- (3) Check whether the radio protocol and channel are configured correctly and are consistent with that of rover.

3. Cannot log in CORS

Solution:

Check whether the 4G SIM card is installed and used normally.

4. Nuwa cannot connect with Oscar

Solutions:

- (1) Check whether Oscar is powered on;
- (2) Re-search and pair Bluetooth;
- (3) Update Nuwa to the latest version.

5. There is no correction data when Oscar as a rover and using Ntrip network

Solutions:

- (1) Check whether IP address, port, user name and password are correct;
- (2) Check network connection, try to compare with PDA network and ensure SIM card contacts with card slot properly;
- (3) Obtain source table to check receiver network, make sure there is no abnormal of CORS service;
- (4) If there is an extra receiver, try logging into the same configurations and make comparisons;
- (5) If you still cannot log in, consult your CORS service provider.

6. How to export static observation data from Oscar?

Solutions:

- (1) Connect Oscar receiver with a computer through a mini USB cable.

- (2) The computer detects the Oscar receiver as an external disk.
- (3) Open the Record folder, find the trs file and Rinex file in its storage according to recording date.
- (4) Copy the static observation data and paste them to the designated folder in your computer.

7. How to calibrate the E-Bubble of Oscar receiver?

Solutions:

- (1) Firstly, install Oscar receiver on the tribrach of a tripod. Adjust the tribrach to enable the bubble to the center.
- (2) Next step, select <Adjust> in the Nuwa under Device Info -> E-Bubble to complete the calibration.

8. How to apply Geoid model file correctly?

Solutions:

- (1) Prepare the Geoid file at first and placed in the path of Internal storage\TersusSurvey\Geoid.
- (2) Next step, launch Nuwa and go to select Project - Current Project and edit Coordinate System. Find the Height Fitting-Adjust Method and select Geoid.
- (3) Last, select the file under Geoid List and apply it.

9. How to configure Oscar serial port output NMEA log?

Solutions:

There are two ways to realize the NMEA sentences output which you'd like to.

- (1) Nuwa can configure to output NMEA by the NMEA option. It can be specified the Baud Rate, the kind of sentence.
- (2) Variable bonus, it can be directly configured on the panel. NMEA can be turned on through Device Info -> Serial.

10. A base receiver is working well, the rover receiver cannot get correction data,

how to fix this?

Solutions:

- (1) Check whether the radio antenna connects well with receiver. Carefully check whether the interface is tightened.
- (2) Check whether the air baud rate, Protocol, Bandwidth, Frequency match right with that of the base receiver.
- (3) Switchover the radio frequency to avoid the possible interference from nearby devices.

11. The Oscar rover works at a short distance (not normal distance) at the radio mode?

Solutions:

- (1) Check whether the rover connects a radio antenna.
- (2) Adjust the radio of base at the high power gear.
- (3) Check the environment if there exists radio interference along the propagation line.

8. Terminology

Abbreviation	Definition
CNR	Carrier Noise Ratio
CRS	Coordinate System
GNSS	Global Navigation Satellite System
HDOP	Horizontal Dilution of Precision
HRMS	Horizontal Root Mean Square
OS	Operating System
PDA	Personal Digital Assistant
PDOP	Position Dilution of Precision
RINEX	Receiver Independent Exchange format
RMS	Root Mean Squares
RTCM	Radio Technical Commission for Maritime Services
RTK	Real-Time Kinematic
SNR	Signal Noise Ratio
UI	User Interface
UTC	Coordinated Universal Time
UTM Projection	Universal Transverse Mercator Projection
VDOP	Vertical Dilution of Precision
VRMS	Vertical Root Mean Square

9. File Format

[.apk]: android app installation file

[.csd]: coordinate system file

[.csv]: excel file

[.dat]: data file

[.dxf]: CAD data file developed by Autodesk

[.ggf]: Geoid file

[.kml]: landmark file developed by Google

[.lnb]: line file

[.shp]: shape file developed by ESRI

[.txt]: text file

Proprietary Notice

All Information in this document is subject to change without notice and does not reflect the commitment on Tersus GNSS Inc. No part of this manual may be reproduced or transmitted by all means without authorization of Tersus GNSS Inc. The software described in this document must be used in terms of the agreement. Any modification without permission from Tersus GNSS Inc. is not allowed.