

# Oscar GNSS Receiver

## User Manual



©2019-2021 Tersus GNSS Inc. All rights reserved.

**Sales Enquiry:** [sales@tersus-gnss.com](mailto:sales@tersus-gnss.com)

**Technical Support:** [support@tersus-gnss.com](mailto:support@tersus-gnss.com)

**More details, please visit** [www.tersus-gnss.com](http://www.tersus-gnss.com)

## Revision History

<b>Version</b>	<b>Revision Date</b>	<b>Change Summary</b>
1.0	20190731	Initial Release
1.1	20191122	Change Yellow&Blue LED to Green LED for Oscar Basic; Add eBubble in section 2.2.2; Update section 1.3.3; Update section 2.4.1; Update section 4.4.
1.2	20200410	Update section 2.4.1, add section 4.4 for tilt function, add table 3.4 for internal radio.
1.3	20200604	Add notice of WEEE; Add view description for LEMO connectors; Add registration steps in section 2.2.2; Update logo picture.
1.4	20200623	Add section 2.5 for web UI.
1.5	20201201	Update section 2.4.1 for firmware upgrade; Update table 3.4 for configuration of internal radio; Update section 4.4 for the LED status of tilt measurement; Update section 4.5 issues and solutions.
1.6	20210324	Update website links in table 0.1 and section 2.4.1; Add a note for firmware upgrade; Add pin definition of TNC connector and battery contacts; Update section 2.3 Data download; Update table 3.1.
1.7	20210610	Update section 2.4.1 for firmware upgrade, add 2.5 Web UI(User Interface).

## Notices

### **CE Marking**

Tersus GNSS Inc. declares that Oscar GNSS receiver is in compliance with the essential requirements (radio performance, electromagnetic compatibility and electrical safety) and other relevant provisions of Radio Equipment Directive 2014/53/EU, Electromagnetic Compatibility (EMC) Directive 2014/30/EU, and Low voltage (LVD) Directive 2014/35/EU. Therefore the equipment is labeled with the following CE-marking.



The Declaration of Conformity may be obtained from Tersus GNSS Inc.

### **RCM Marking**

Tersus GNSS Inc. declares that Oscar GNSS receiver is in compliance with the essential requirements (electrical safety, EMC, & telecommunications) from Australian & New Zealand RCM compliance requirements. Therefore the equipment is labeled with the following RCM-marking.



The Declaration of Conformity may be obtained from Tersus GNSS Inc.

## KC Marking

Tersus GNSS Inc. declares that Oscar GNSS receiver is in compliance with the essential requirements for safety certification of electrical products from Korea Agency for Technology and Standards (KATS). Therefore the equipment is labeled with the following KC-marking.



R-C-Tgn-51820301133

## Restriction of User of Certain Hazardous Substances (RoHS)

Tersus GNSS Inc. declares that Oscar GNSS receiver is in compliance with the restriction of the use of certain hazardous substances in electrical and electronic equipment (RoHS) RoHS Directive 2011/65/EU and its Amendment Directives (EU) 2015/863.

## Waste Electrical and Electronic Equipment (WEEE)



This product must not be disposed with household waste.

Dispose of the product appropriately in accordance with the national regulations in force in your country.

Always prevent access to the product by unauthorised personnel.



Product-specific treatment and waste management information can be received from your local Tersus distributor.

# Safety Information

Make sure that you have read and understood all safety requirements before you start using Tersus product.

## Conventions

The following conventions are used in this manual:

	Information that supplements or clarifies text.
---	---

	A caution that actions, operation or configuration may lead to incorrect or improper use of the hardware.
---	---

	A warning that actions, operation or configuration may result in regulatory noncompliance, safety issues or equipment damage.
---	---

The following notices apply to all three versions of Oscar GNSS receivers.

	Operating or storing the receiver outside the specified temperature range can damage it.
---	--

	Changes or modifications to this equipment not expressly approved by Tersus could void the user's authority to operate this equipment or even has risk to damage the receivers.
---	---

	DO NOT use the receiver in a thunderstorm as there is increasing risk of being struck by lightning.
---	---

	Install the radio antenna before switching the radio transceiver to
---	---

	transmit mode, or the radio transceiver may be damaged due to overheating. The energy to be transmitted cannot be emitted out without the antenna, which may cause the temperature rise and overheat of the radio module.
--	---

	<p><b>Safety: exposure to radio frequency (RF)</b></p> <p>Exposure to RF energy is an important safety consideration. Although our product is compliance with the safety standard released by various standard organizations, the following precautions are recommended to ensure low exposure to radio frequency radiation.</p> <ul style="list-style-type: none"><li>● DO NOT operate the transmitter when someone is within the following distances of the antenna:<ul style="list-style-type: none"><li>➤ Bluetooth, Wi-Fi, GSM/UTMS – less than 20cm</li><li>➤ 410-470MHz UHF radio – less than 47cm</li></ul></li><li>● DO NOT operate the transmitter unless all RF connectors are secured and any open connectors are properly terminated.</li><li>● DO NOT operate the equipment near electrical blasting caps or in an explosive atmosphere.</li><li>● All equipment must be properly grounded.</li><li>● All equipment should be serviced only by a qualified technician.</li></ul>
---	--

## Related Documentation

Table 0.1 Document and software used in this user manual

Name	Description	Link
Log & Command document	Document providing all the loggings output from BX series receivers and all the commands to the receivers.	<a href="https://www.teresus-gnss.com/document">https://www.teresus-gnss.com/document</a> under GNSS OEM Board / User Manual
Tersus Tool Suite	Tersus Tools including TersusDownload, TersusGeoPix, TersusGNSSCenter, TersusUpdate, TersusRinexConverter	<a href="https://www.teresus-gnss.com/software">https://www.teresus-gnss.com/software</a>
Nuwa	Survey application running in the Android platform, David, Oscar and other NMEA devices can be configured with Nuwa.	<a href="https://www.teresus-gnss.com/software/osc-ar-gnss-receiver">https://www.teresus-gnss.com/software/osc-ar-gnss-receiver</a>
Tersus Geomatics Office	Post processing tool for static data.	<a href="https://www.teresus-gnss.com/software/david-receiver">https://www.teresus-gnss.com/software/david-receiver</a>

## Support

If there is any problem and the information needed cannot be found in the product documentation, log a technical support ticket in our tracking system

<https://teresus.supportsystem.com/> , or mail to [support@teresus-gnss.com](mailto:support@teresus-gnss.com).

# Table of Content

Revision History.....	2
Notices.....	3
Safety Information.....	5
Table of Content.....	8
List of Figures.....	10
List of Tables.....	13
1. Introduction.....	15
1.1 Overview.....	15
1.2 Receiver features.....	16
1.3 Devices in the package.....	17
1.3.1 Oscar GNSS receiver.....	17
1.3.2 Battery and charger.....	24
1.3.3 TC20 controller.....	27
1.3.4 External radio for Oscar.....	30
1.3.5 Other accessories.....	32
2. General Operations.....	38
2.1 Setting up Oscar.....	38
2.1.1 Insert the battery.....	38
2.1.2 Insert the SIM card.....	40
2.1.3 Fix Oscar on a tripod or ranging pole.....	41
2.2 Oscar configuration.....	43
2.2.1 Configure via buttons.....	43
2.2.2 Configure via TC20 controller.....	46
2.3 Data download.....	52
2.3.1 Connection.....	52



2.3.2 Download static data.....	52
2.3.3 Download debug data.....	53
2.4 Firmware upgrade.....	55
2.4.1 Wired upgrade.....	55
2.4.2 Wireless upgrade.....	60
2.5 Web UI.....	61
2.6 Operations of TC20 controller.....	65
2.6.1 Insert SIM card and Micro SD card.....	65
2.6.2 Micro SD Card.....	67
2.6.3 Using of touch screen.....	68
3. Technical Specifications.....	69
3.1 Oscar GNSS receiver.....	69
3.2 TC20 controller.....	72
3.3 External radio for Oscar.....	74
4. Typical Applications.....	76
4.1 Base station operation.....	76
4.2 Rover operation.....	84
4.3 Static survey.....	90
4.4 Tilt survey and stakeout.....	93
4.4.1 Tilt initialization.....	93
4.4.2 Tilt survey.....	94
4.4.3 Tilt stakeout.....	96
4.5 Issues and solutions.....	97
5. Terminology.....	101

## List of Figures

Figure 1.1	Oscar GNSS receiver - Ultimate.....	17
Figure 1.2	Oscar GNSS receiver - Advanced .....	17
Figure 1.3	Oscar GNSS receiver - Basic .....	17
Figure 1.4	Buttons and display on Oscar Ultimate.....	19
Figure 1.5	Buttons and display on Oscar Advanced.....	20
Figure 1.6	Buttons and LEDs on Oscar Basic.....	21
Figure 1.7	Bottom of Oscar GNSS receiver.....	23
Figure 1.8	BN20 Battery.....	24
Figure 1.9	CN20 Charger.....	24
Figure 1.10	CN20 Charger with two BN20 batteries.....	25
Figure 1.11	CN20 Charger Adapter.....	25
Figure 1.12	CN20 Charger Adapter Cable (A/B/C/E/N).....	26
Figure 1.14	TC20 lithium battery.....	29
Figure 1.15	TC20 charger adapter.....	29
Figure 1.16	TC20 charger adapter plugs.....	29
Figure 1.17	TC20 controller hand strap.....	30
Figure 1.18	Stylus pen for TC20.....	30
Figure 1.19	External radio for Oscar.....	30
Figure 1.20	High gain radio antenna .....	31
Figure 1.21	Telescopic pole for radio antenna .....	31
Figure 1.22	Serial-5pin to External-Radio-DC-5pin & Bullet-DC Cable.....	31
Figure 1.23	Bullet-DC to Alligator Clips.....	32
Figure 1.24	GNSS antenna connector.....	32
Figure 1.25	Height measure accessory.....	32
Figure 1.26	Tape measure.....	33
Figure 1.27	410-470MHz radio whip antenna .....	33

Figure 1.28	Mini USB cable.....	33
Figure 1.29	Mini-USB OTG cable.....	34
Figure 1.30	Extension pole 30cm.....	34
Figure 1.31	Metal fixing plate.....	34
Figure 1.32	Ranging Pole.....	35
Figure 1.33	Bracket for TC20.....	35
Figure 1.34	Carrying Case .....	35
Figure 1.35	Tool bag.....	36
Figure 1.36	Serial-5pin to DC JACK & DB9 male cable.....	36
Figure 1.37	DC JACK male with two wires.....	36
Figure 1.38	DB9 Female to USB Type A Male converter cable.....	37
Figure 1.39	Configuration cable for 25W radio.....	37
Figure 2.1	Open the battery cover .....	38
Figure 2.2	Put one battery in Oscar.....	38
Figure 2.3	Insert the SIM card.....	40
Figure 2.4	Oscar as a base without radio antenna.....	41
Figure 2.5	Oscar as a rover without radio antenna.....	42
Figure 2.6	Device functional group.....	46
Figure 2.7	Connect Oscar via Bluetooth .....	47
Figure 2.8	Device info of Oscar.....	47
Figure 2.9	eBubble before adjusting.....	48
Figure 2.10	eBubble after adjusting.....	48
Figure 2.11	Example of Oscar’s registration file.....	49
Figure 2.12	Base configuration.....	50
Figure 2.13	Rover configuration.....	50
Figure 2.14	Link status of Base.....	51
Figure 2.15	Link status of Rover.....	51
Figure 2.16	Connect Oscar to a computer.....	52

Figure 2.17	Static record folder.....	53
Figure 2.18	Static data for one day.....	53
Figure 2.19	rtkmain.log file location.....	53
Figure 2.20	Debug info folders.....	54
Figure 2.28	Make Wi-Fi connection.....	62
Figure 2.29	Sign in the web UI.....	62
Figure 2.34	Insert Micro SD card.....	66
Figure 2.35	Insert the back cover.....	67
Figure 2.36	Select USB function.....	68
Figure 3.1	Serial data port of Oscar.....	71
Figure 4.1	Oscar as a base - network mode.....	76
Figure 4.2	Oscar as a base - internal radio.....	77
Figure 4.3	Oscar as a base – external radio.....	78
Figure 4.4	Base setting interface.....	80
Figure 4.5	Base configuration - Receiver Network (TCS).....	81
Figure 4.6	Base configuration – PDA Network (Ntrip).....	81
Figure 4.7	Base configuration - Internal Radio .....	82
Figure 4.8	Base configuration - External Radio .....	82
Figure 4.9	Link status of base using internal radio.....	83
Figure 4.10	Oscar as a Rover - Network Mode.....	84
Figure 4.11	Oscar as a Rover - Internal Radio.....	85
Figure 4.12	Rover setting interface.....	87
Figure 4.13	Rover configuration - Internal Radio .....	88
Figure 4.14	Rover configuration - Receiver Network (TCS).....	88
Figure 4.15	Rover configuration - Receiver Network (Ntrip).....	89
Figure 4.16	Rover configuration - PDA Network (Ntrip).....	89
Figure 4.17	Link status of Rover using internal radio.....	90
Figure 4.18	Static Survey configuration.....	92

Figure 4.19	Detailed information of tilt compensation.....	94
Figure 4.20	Tilt status is ON.....	95
Figure 4.21	Point stakeout when tilt compensation is on.....	96

## List of Tables

Table 0.1	Document and software used in this user manual.....	7
Table 1.1	Usage of FN button for three versions.....	18
Table 1.2	LED indicators on Ultimate version.....	19
Table 1.3	LED indicators on Advanced version.....	20
Table 1.4	LED indicators on Basic version.....	21
Table 1.5	Possible LED flash patterns.....	22
Table 1.6	Receiver ports on the bottom side.....	23
Table 2.1	Devices to set Oscar as a base without radio antenna.....	41
Table 2.2	Devices to set Oscar as a rover without radio antenna.....	42
Table 2.3	Button configuration for Oscar Ultimate and Advanced.....	43
Table 2.4	Configuration menu for Oscar Ultimate and Advanced.....	44
Table 2.5	Button configuration for Oscar Basic.....	45
Table 3.1	Oscar GNSS receiver performance .....	69
Table 3.2	Pin definition of the serial data port.....	71
Table 3.3	Pin definition of the TNC connector.....	71
Table 3.4	Pin definition of the battery contacts.....	71
Table 3.5	Default factory configuration for internal radio.....	71
Table 3.6	Detailed configuration information for internal radio.....	72
Table 3.7	TC20 technical specification.....	72
Table 3.8	External radio RS400H2 technical specification.....	74

Table 3.9	Default factory configuration for Radio RS400H2.....	75
Table 4.1	Devices of Oscar as a base network mode.....	77
Table 4.2	Devices of Oscar as a base internal radio mode.....	77
Table 4.3	Devices of Oscar as a base external radio mode.....	78
Table 4.4	Devices of Oscar as a rover network mode.....	84
Table 4.5	Devices of Oscar as a rover internal radio mode.....	85

# 1. Introduction

This chapter includes overview, receiver features, and devices in the package.

## 1.1 Overview

The Oscar GNSS receiver is a new generation GNSS RTK system. It supports calibration-free tilt compensation function which is immune to magnetic disturbances, leveling pole is not required. Easy configuration with 1.54 inch interactive screen on Ultimate and Advanced versions. With an internal high-performance multi-constellation and multi-frequency GNSS board, the Oscar GNSS receiver can provide high accuracy and stable signal detection. The high-performance antenna can speed up the time to first fix (TTFF) and improve anti-jamming performance. The built-in large capacity battery is detachable, two batteries support up to 16 hours of field work in 4G/3G/2G network and Rover radio mode. The built-in UHF radio module supports long distance communication. The rugged housing protects the equipment from harsh environments.

The Oscar GNSS receiver has three versions: Ultimate, Advanced, and Basic. It provides selectivity for the requirement from different users.

## 1.2 Receiver features

The Oscar GNSS receiver has following features:

- Supports multiple constellations & frequencies
  - GPS L1C/A, L2C, L2P, L5
  - GLONASS L1C/A, L2C/A
  - Beidou B1, B2, B3 (BDS-3)
  - Galileo E1, E5a, E5b
  - QZSS L1C/A, L2C, L5
- Supports 576 channels.
- Supports 410-470MHz UHF radio, 4G network, Wi-Fi<sup>(1)</sup>, Bluetooth, NFC.
- Tilt compensation without calibration, immune to magnetic disturbances<sup>(2)</sup>.
- 16GB/8GB internal storage
- Up to 16 hours<sup>(3)</sup> working in 4G/3G/2G network and Rover radio mode
- IP68-rated dust- & waterproof enclosure, for reliability in harsh environmental conditions
- Free subscription of Tersus Caster Service (TCS): transmit the correction data from Oscar Base to Rover

Note:

(1) Tilt compensation is only applicable for Ultimate version.

(2) One battery lasts up to 8 hours when Oscar works in 4G/3G/2G network and Rover radio mode. Two batteries add up to total 16 hours use.



## 1.3 Devices in the package

The devices in the package may vary according to the customer requirement. Here describes the major parts in the package.

### 1.3.1 Oscar GNSS receiver

The Oscar GNSS receiver has three versions which are shown as below.



Figure 1.1 Oscar GNSS receiver - Ultimate



Figure 1.2 Oscar GNSS receiver - Advanced



Figure 1.3 Oscar GNSS receiver - Basic

## Buttons

Two buttons are equipped on each version of Oscar GNSS receiver.

: Power ON/OFF button. When the device is off, long press it for 2 seconds to power on the receiver. When the receiver is on, long press it for over 3 seconds to power off the receiver. In addition, for Ultimate and Advanced versions, in normal operation state this button is used as function selection confirmation button working with the FN button which is explained below.

: Function (FN) button. This button has different functions for different versions which is listed in the table below.

Table 1.1 Usage of FN button for three versions

FN button	Ultimate	Advanced	Basic
Selecting / Switching	On the Device Config page, press it once to lead the cursor jump to the next row or next page or previous page. When the cursor stops at an item, pressing the power button enters the sub menu of this item for function selecting or return.		Switch static survey. After pressing it for 3s to turn on the static recording function. Then press it to turn on the static mode. Press and hold it for 3s to turn off the static function.
Wake up	Tap the power button or FN button to wake up the OLED screen when the OLED screen is off.		N/A

### Combination Function of the two buttons

Press and hold the FN button, continuously tap the ON/OFF button 5 times to reset the GNSS module and make it re-search the satellites. Detailed LED flash status related to this operation refers to the LED flash patterns table.

## LED Indicators

Four LED indicators and **one** OLED display screen are for Ultimate version and Advanced version. **Six** LED indicators are for Basic version of Oscar GNSS receiver. The LEDs on the front panel indicate various operating conditions. The detailed LED Descriptions are shown in the tables below.

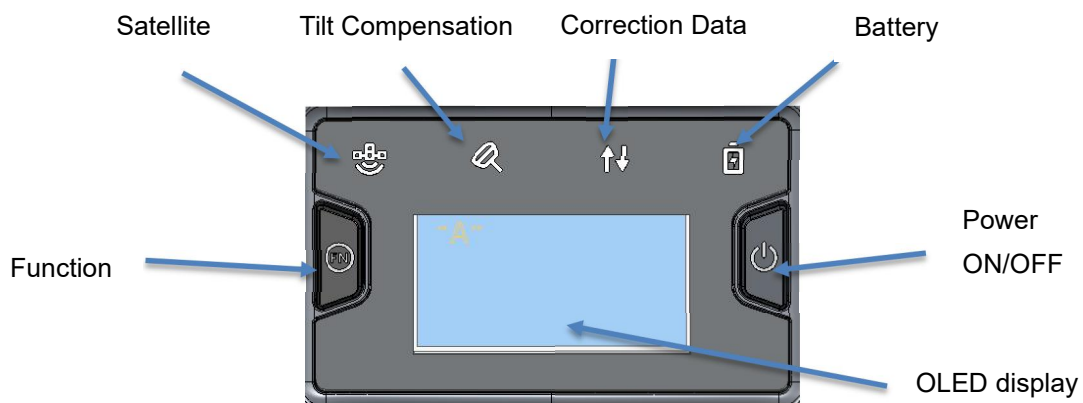





Figure 1.4 Buttons and display on Oscar Ultimate

Table 1.2 LED indicators on Ultimate version

LED indicator	Description
 Satellite	Green LED. Flashing every 5 seconds indicates that it is searching satellites. After satellites are searched, it flashes N times every 5 seconds, in which N indicates N satellites are found.
 Tilt compensation	Green & Red LED. When tilt compensation is turned on, it is steady red; when it is preparing for tilt compensation, it flashes red; when tilt compensation is valid, the LED is steady green.
 Correction data	Green and Red LED. Green indicates correction data, and red indicates solution status.
 Battery	Green LED. Steady green in normal operation. Slow flash indicates the battery level is between 30% and 10%. Fast flash indicates the battery level is below 10% and reminds users to change battery.

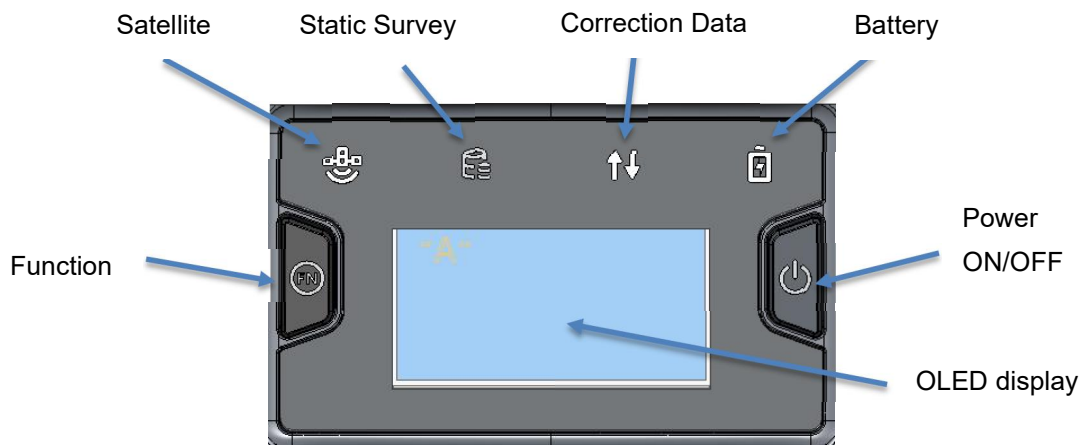





Figure 1.5 Buttons and display on Oscar Advanced

Table 1.3 LED indicators on Advanced version

LED indicator	Description
 Satellite	Green LED. Flashing every 5 seconds indicates that it is searching satellites. After satellites are searched, it flashes N times every 5 seconds, in which N indicates N satellites are found.
 Static Survey	Green LED indicates static survey mode.
 Correction data	Green and Red LED. Green indicates correction data, and red indicates solution status.
 Battery	Green LED. Steady green in normal operation. Slow flash indicates the battery level is between 30% and 10%. Fast flash indicates the battery level is below 10% and reminds users to change battery.

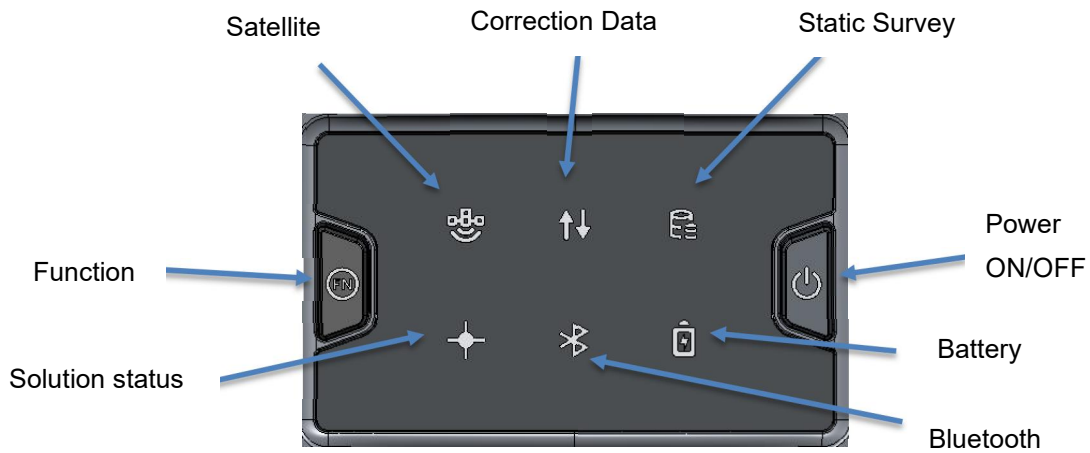







Figure 1.6 Buttons and LEDs on Oscar Basic

Table 1.4 LED indicators on Basic version

LED indicator	Description
 Satellite	Green LED. Flashing every 5 seconds indicates that it is searching satellites. After satellites are searched, it flashes N times every 5 seconds, in which N indicates N satellites are found.
 Correction data	Green LED indicates correction data.
 Static Survey	Green LED indicates static survey mode.
 Solution status	Green LED. Steady green indicates fixed solution, flashing 1Hz indicates floating solution, off light for other solutions.
 Bluetooth	Green LED indicates Bluetooth status. Steady green indicates successful Bluetooth pair, off light indicates no Bluetooth paired.
 Battery	Green LED. Steady green in normal operation. Slow flash indicates the battery level is between 30% and 10%. Fast flash indicates the battery level is below 10% and reminds users to change battery.

## LED Flash Patterns

The possible flash patterns of various states of receiver operation are listed in the table below.

Table 1.5 Possible LED flash patterns

Receiver mode	Button operation	LED flash patterns
Receiver OFF	N/A	All LEDs are off.
Receiver ON	Long press the power button for 2s	All LEDs are on, then all off, and each LED starts to indicate current status after initialization.
Low power	N/A	Battery LED flashes slow.
Battery exhausting	N/A	Battery LED flashes fast.
Searching satellites	N/A	Satellite LED flashes every 5s
Satellites tracked	N/A	Satellite LED flashes N times every 5s, in which N is the quantity of satellites tracked.
Receiving valid data packet	N/A	Correction data LED flashes green at 1Hz
Fixed solution	N/A	Correction data LED is steady red for Ultimate and Advanced versions, Solution status LED is steady green for Basic version.
Floating solution	N/A	Correction data LED flashes red at 1Hz for Ultimate and Advanced versions, Solution status LED flashes green at 1Hz for Basic version.
Reset GNSS module	Press and hold the FN button, continuously tap the ON/OFF button 5 times	All LEDs light up for 5 seconds.
Turn on static mode	Press FN button for 3s	Static/Tilt LED flashes 3 times continuously.
Turn off static mode	Press FN button for 3s	The correction data LED flashes 3 times continuously.
Firmware upgrade	N/A	For Basic version, all six LEDs are on for 1s thereafter only power LED lights up, then all LEDs light up when upgrading, lights off when restarting. Then all six LEDs light up for 1s thereafter only power LED lights up means it restarts successfully with updated firmware.

**Note: N/A means Not Applicable.**

## Receiver Ports

The bottom of Oscar receiver is shown as below.

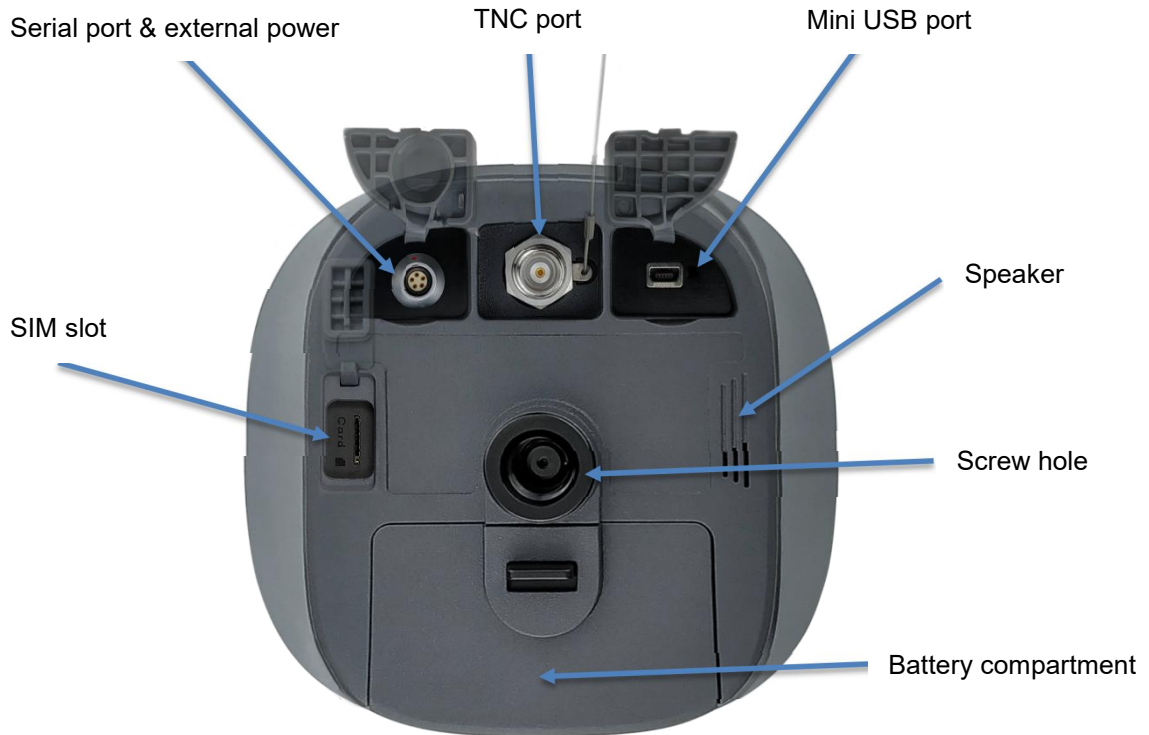









Figure 1.7 Bottom of Oscar GNSS receiver

Table 1.6 Receiver ports on the bottom side

Icon	Connector	Name	Connections
		Serial port & external power	External power, RS-232 communication, external radio
		Mini USB port	Device, computer, USB drive
SIM		SIM slot	Nano SIM card
-		TNC port	410-470MHz radio antenna
-		Screw hole	5/8" x 11 UNC-2B connector for corresponding connector and pole.

### 1.3.2 Battery and charger

Oscar equips smart lithium batteries which can detect electricity and display the power level intelligently. The Oscar GNSS receiver can also be powered by external power source via serial data port. The built-in large capacity battery is detachable, two batteries support up to 16 hours of field work in 4G/3G/2G mode and rover radio mode.

The BN20 battery is shown as below. Press the button on the top, it shows the power level left to be consumed.



Figure 1.8 BN20 Battery

The CN20 Charger is able to charge two BN20 batteries at the same time which is shown in the figures below.



Figure 1.9 CN20 Charger



Place two BN20 batteries in the slots of CN20 charger.



Figure 1.10 CN20 Charger with two BN20 batteries

Insert the DC Jack connector of the adapter to the CN20 charger, then make the adapter with cable plug in the local AC outlet (100~240V AC) to start charging.



Figure 1.11 CN20 Charger Adapter

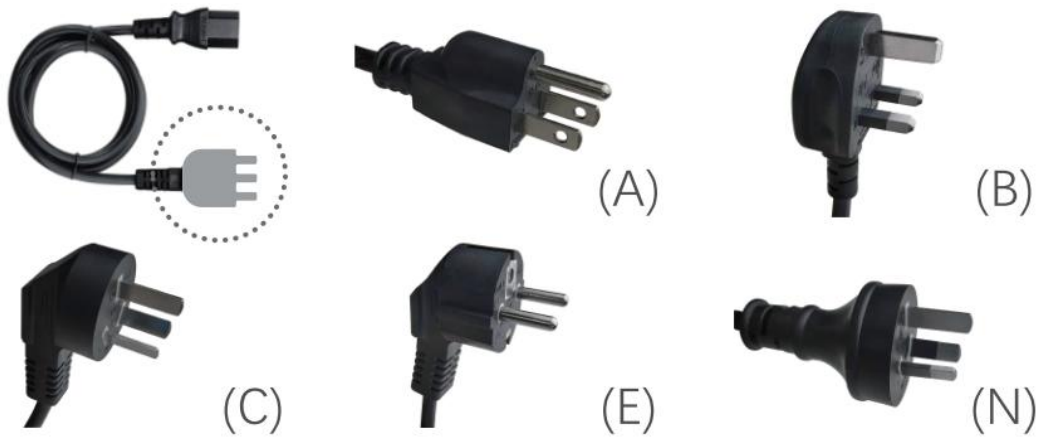

Figure 1.12 CN20 Charger Adapter Cable (A/B/C/E/N)

**Note: The model of the CN20 charger adapter cable will be delivered according to customer requirements.**

**A: American, B: British, C: Chinese, E: European, N: Australian**

Charge the battery completely before using it for the first time. The charging takes approximately 3 hours per battery at room temperature. If the battery has been stored for longer than three months, charge it before use.

### 1.3.3 TC20 controller

The Tersus TC20 Controller is a rugged android smart phone with design of 4.3" touch screen and an alphanumerical keypad. Equipped with powerful processor, it is perfect to adapt with Tersus Survey software. With professional IP68 rating, it is robust and reliable for harsh operating conditions.

#### Features:

- Rugged smart phone 4.3" display
- 4G GSM unlocked Android 6.0
- Quad-Core 1.3GHz CPU
- 2GB RAM + 16GB ROM
- 8 MP Auto Focus camera
- IP68 certified grade, water/shock/dust proof
- 6500 mAh battery
- Wi-Fi, Bluetooth, NFC
- Two color options: red and yellow

***Note: Although the TC20 controller uses chemical and impact resistant materials, precision instruments require careful use and maintenance and should be kept as dry as possible. In order to improve the stability and life cycle of the TC20 controller, avoid exposing the TC20 controller to extreme environments such as moisture, high temperatures, low temperatures, corrosive liquids or gases.***



TC20 must be in the specified temperature range -20 °C ~ 55 °C when used and stored.

**Power on:** Press and hold the power button for 3 seconds. Short press to wake up the screen.

**Power off:** Press and hold the power button for 3 seconds, select 'power off' in the menu option.



Figure 1.13 Four sides of TC20 controller

**Menu key:** Select to show the available menu in current screen.

**Home key:** Return to home screen. Press and hold it to view recent application.

**Back key:** Return to previous screen.

**APP key:** launch Nuwa app.

**Point key:** collect point manually under survey interface.

**FN key:** shift keypad language under some input method.

**OK key:** confirm or wrap to the next line.

Accessories of TC20 controller:

TC20 lithium battery (3.7V/6500mAh)



Figure 1.14 TC20 lithium battery

TC20 charger adapter (5V/1A) with one USB port



Figure 1.15 TC20 charger adapter



Figure 1.16 TC20 charger adapter plugs

A: American, B: British, C: Chinese, E: European, N: Australian

Put the plug in in the back of the adapter to assemble the TC20 charger.

The hand strap below is for easy handling of TC20 controller.



Figure 1.17 TC20 controller hand strap

The stylus pen below is for easy touch of screen on TC20 controller.



Figure 1.18 Stylus pen for TC20

### 1.3.4 External radio for Oscar

The external radio RS400H2 for Oscar below is to be installed via serial data port, and it can help Oscar transmitting signals farther than internal radio.



Figure 1.19 External radio for Oscar

When using external radio for Oscar as a base, a high gain radio antenna and a telescopic pole are needed which are shown as below.



Figure 1.20 High gain radio antenna



Figure 1.21 Telescopic pole for radio antenna

The following Serial-5pin to External-Radio-DC-5pin & Bullet-DC Cable and Bullet-DC to Alligator Clips are used to communicate with Oscar and connect to external power supply.



Figure 1.22 Serial-5pin to External-Radio-DC-5pin & Bullet-DC Cable



Figure 1.23 Bullet-DC to Alligator Clips

### 1.3.5 Other accessories

Other accessories may be packed according to customer requirements.

The GNSS antenna connector is used to install Oscar to a tripod.



Figure 1.24 GNSS antenna connector

The height measure accessory is used to determine the height of Oscar with higher accuracy.



Figure 1.25 Height measure accessory



The tape measure below is to help measure height.



Figure 1.26 Tape measure

The 410-470MHz radio whip antenna is to be installed on the TNC port to transmit or receive signal for the internal radio.



Figure 1.27 410-470MHz radio whip antenna



Figure 1.28 Mini USB cable

Mini USB cable functions:

1. Connect Oscar to the USB port of computer for data downloading;
2. Connect the mini USB port of TC20 to charge TC20 controller.

When upgrading firmware with a wire, you need a Mini-USB OTG cable. The detailed usage refers to section 2.4.1.



Figure 1.29 Mini-USB OTG cable

When installing 410-470MHz radio whip antenna on Oscar, it is necessary to use a 30cm extension pole to heighten Oscar and avoid bending the 410-470MHz radio whip antenna.



Figure 1.30 Extension pole 30cm

This metal fixing plate is used to fixate the high gain radio antenna to the tripod.



Figure 1.31 Metal fixing plate

When using Oscar as a rover, you need a ranging pole.



Figure 1.32 Ranging Pole

The bracket for TC20 controller is to fix the TC20 controller on a ranging pole.



Figure 1.33 Bracket for TC20

A yellow carrying case is to store all the devices and accessories except ranging pole, high gain radio antenna and telescopic pole.



Figure 1.34 Carrying Case

The tool bag below is to store high gain radio antenna and telescopic pole for radio antenna.



Figure 1.35 Tool bag

The Serial-5pin to DC JACK & DB9 Male cable and the DC JACK male with two wires (the brown wire connects to power and the blue wire connects to ground) below are optional. It is to power Oscar using external power source instead of the BN20 battery.



Figure 1.36 Serial-5pin to DC JACK & DB9 male cable



Figure 1.37 DC JACK male with two wires

The DB9 Female to USB Type A Male converter cable is to convert DB9 male to USB Type A male connector, so that it can connect to the USB port of a computer.



Figure 1.38 DB9 Female to USB Type A Male converter cable

The configuration cable for 25W radio below is used to configure parameters of the 25W radio instead of the default setting.



Figure 1.39 Configuration cable for 25W radio

## 2. General Operations

This chapter includes setting up, configuration and other related operations.

### 2.1 Setting up Oscar

#### 2.1.1 Insert the battery

Open the battery cover, notice the metal contact on the bottom, put one battery align the metal contact position, and make sure the button end is close to the battery compartment.





Figure 2.1 Open the battery cover

Push the battery in the direction of the arrow on the top, the battery is properly installed after a 'click', then close the cover and lock it.



Figure 2.2 Put one battery in Oscar

More details about batteries refer to section 1.3.2 Battery and Charger.

	<p>DO NOT damage the rechargeable Lithium-ion battery. A damaged battery can cause an explosion or fire, and can result in personal injury and/or property damage.</p> <p>To prevent injury or damage:</p> <ul style="list-style-type: none"> <li>- DO NOT use or charge the battery if it appears to be damaged. Signs of damage include, but are not limited to, discoloration, warping, and leaking battery fluid.</li> <li>- DO NOT expose the battery to fire, high temperature, or direct sunlight.</li> <li>- DO NOT immerse the battery in water.</li> <li>- DO NOT use or store the battery inside a vehicle in hot weather.</li> <li>- DO NOT drop or puncture the battery.</li> <li>- DO NOT open the battery or short-circuit its contacts.</li> </ul>
	<p>DO NOT contact with the rechargeable Lithium-ion battery if it appears to be leaking. Battery fluid is corrosive, and contact with it can result in personal injury and/or property damage.</p>
	<p>Discharge a Lithium-ion battery before disposing of it. Dispose of batteries in an environmentally sensitive manner, and adhere to any local and national regulations concerning battery disposal or recycling.</p>

To remove the battery, slide the battery in the opposite direction of the arrow and then take out the battery from the battery compartment.

## 2.1.2 Insert the SIM card

When 4G/3G/2G network is chosen for survey operation, you need to insert a nano SIM card into Oscar GNSS receiver. Insert the nano SIM card with the contacts facing outside which is shown as below.



Figure 2.3 Insert the SIM card

To eject the nano SIM card, slightly push it in to trigger the spring-loaded release mechanism.

**Note: The SIM card is provided by your cellular network service provider.**



### 2.1.3 Fix Oscar on a tripod or ranging pole

Oscar GNSS receiver has a standard 5/8" x 11 UNC-2B connector and it can be fixed on a tripod or a ranging pole to be a base or rover according to customer requirement.



Figure 2.4 Oscar as a base without radio antenna

Table 2.1 Devices to set Oscar as a base without radio antenna

Device Name	Quantity	Items in the figure
Oscar GNSS receiver	1	1, details refer to section 1.3.1
Height measure accessory	1	2, details refer to section 1.3.4
GNSS antenna connector	1	3, details refer to section 1.3.4
Tribrach	1	4
Tripod	1	5



Figure 2.5 Oscar as a rover without radio antenna

Table 2.2 Devices to set Oscar as a rover without radio antenna

Device Name	Quantity	Items in the figure
Oscar GNSS receiver	1	1, details refer to section 1.3.1
Ranging pole	1	2, details refer to section 1.3.4
Bracket for TC20	1	3
TC20 Controller	1	4, details refer to section 1.3.3

## 2.2 Oscar configuration

You can configure Oscar GNSS receiver via buttons, TC20 controller or other android devices.

### 2.2.1 Configure via buttons

The detailed definition of buttons on Oscar GNSS receiver refers to Figure 1.4, Table 1.1, and related context. The OLED screen is display for Ultimate and Advanced versions, and no display for Basic version. Therefore the button configurations are different which are listed below.

Table 2.3 Button configuration for Oscar Ultimate and Advanced

Action	Button operation	Description
Turn on the receiver	Press the power button for 2s	All four LEDs light up and remain for 3s, then all go off and battery LED is steady green if battery level is >30%.
Turn off the receiver	Press the power button for 3s	All four LEDs light off.
Wake up	Tap the power button or FN button to wake up the OLED screen when the OLED screen is off.	Screen off to on.
Select	Press FN button	
Confirm	Press the power button	Confirm, cancel, or return.
Reset GNSS module	Press and hold the FN button, continuously tap the power button 5 times	All LEDs light up for 5 seconds.

Table 2.4 Configuration menu for Oscar Ultimate and Advanced

Home screen	Level 1	Level 2	Level 3
SV (Satellite)	/	/	/
BAT(Battery)	/	/	/
Mode Status	/	/	/
Mode Config	Base Mode	TCS (Tersus Caster Service)	Set format, server.
		NTRIP Server	Set format
		Internal Radio	Set protocol, format, power, channel, and frequency.
		External Radio	Set baud rate, format.
	Rover Mode	TCS (Tersus Caster Service)	Set Base ID, server.
		NTRIP Client	Set IP address and port.
		TCP Client	Set IP address.
		Internal Radio	Set protocol, channel, and frequency.
	Single Mode	Confirm/Cancel	/
	Tilt Compensation	ON or OFF	/
	Static survey	View static survey recording time; set frequency, mask elevation, duration, antenna height, measure type, data format, and RINEX format.	/
Device Info	GNSS info	Constellation, RTK mode, reset RTK, hardware, and firmware.	/
	Voice	ON or OFF	/
	Change battery	ON or OFF	/
	Cellular	ON or OFF	/
	Internal Radio	Frequency, power, protocol, air baud rate, and channel.	/
	Bluetooth	Name, status and MAC.	/
	Disk management	Disk use, empty disk, download log.	/
	Data broadcast	Set Bluetooth, serial port, baud rate, NMEA, and tilt data.	/
	Debug mode	Debug info selection	/
	Language	Language options	/

	Registration status	/	/
	SN (Serial Number)	/	/
	PN (Part Number)	/	/
	FW (Firmware)	/	/
	HW (Hardware)	/	/

Table 2.5 Button configuration for Oscar Basic

Action	Button operation	Description
Turn on the receiver	Press the power button for 2s	All six LEDs light up and remain for 3s, then all go off and battery LED is steady green if battery level is >30%.
Turn off the receiver	Press the power button for 3s	All six LEDs light off.
Turn on static recording	Press and hold FN button for 3s	Static LED light on
Turn off static recording	Press and hold FN button for 3s	Static LED light off
Reset GNSS module	Press and hold the FN button, continuously tap the power button 5 times	All LEDs light up for 5 seconds.

## 2.2.2 Configure via TC20 controller

The detailed introduction of TC20 controller refers to section 1.3.3 and technical specification refers section 3.2. Here in this section describes how to configure Oscar via Nuwa app which is installed in TC20 controller.

### 2.2.2.1 Connect Oscar in Nuwa

The general operations of Nuwa app refer to *User Manual for Nuwa App* which can be downloaded on Tersus official website.

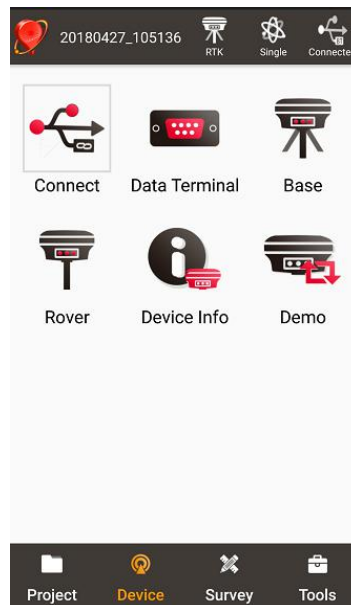

Figure 2.6 Device functional group

When Oscar GNSS receiver is powered on, to connect Oscar, put TC20 controller near the NFC logo on Oscar, the TC20 controller pair Bluetooth with Oscar automatically; or click [Device] -> [Connect] under an opened project, and select [Oscar] for the Device Type which is shown as below.

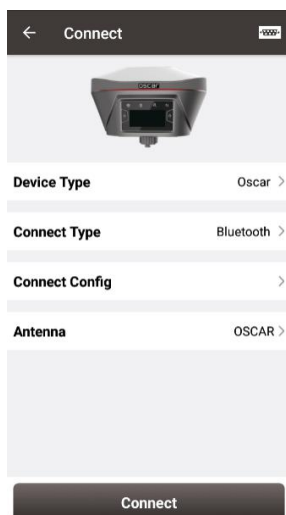



Figure 2.7 Connect Oscar via Bluetooth

Select [Bluetooth] for the Connect Type. Click [Connect Config] to search and pair the Bluetooth address of Oscar. The antenna is selected as [Oscar] by default. Then click [Connect] to enable the communication between TC20 controller and Oscar.

### 2.2.2.2 Electronic Bubble (eBubble)

Make the body of Oscar stand on a leveled Tribrach before eBubble calibration.

Click the device information icon  on the top tool bar of Nuwa, the Oscar info is shown as below.

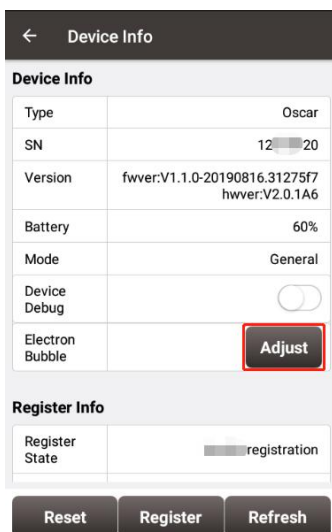

Figure 2.8 Device info of Oscar

Click **Adjust** on the right of electronic bubble to adjust bubble. On the screenshot below, the eBubble is not in the black circle and its color is red for warning purpose.

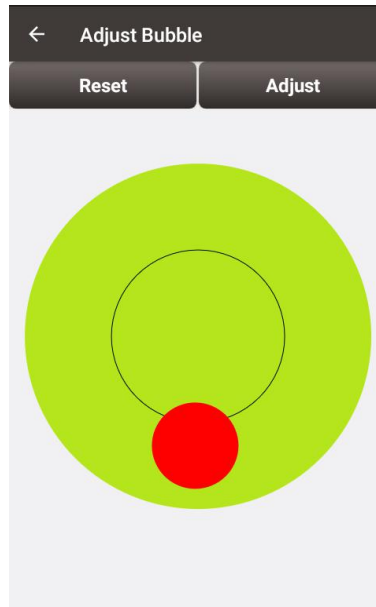

Figure 2.9 eBubble before adjusting

Click **Adjust** on the right, the eBubble is calibrated to the center inside the black circle and the bubble color turns blue.

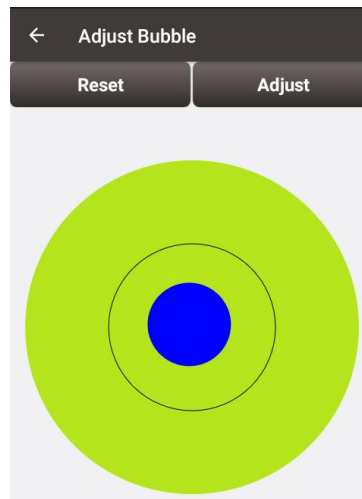

Figure 2.10 eBubble after adjusting

### 2.2.2.3 Registration

When the registration is not effective, follow below steps to complete the registration.



- 1) Connect the TC20 controller to your computer with a mini USB cable, and choose "Use USB for Transfer files" on the TC20 screen.
- 2) Click TC20 -> Internal storage -> TersusSurvey on the computer, then copy the license file obtained from Tersus Technical Support to the "TersusSurvey" folder.
- 3) Open Nuwa app on TC20, click [Register] in Device information interface. Click [Refresh] to update the registration status.

**Note:**

- a) The registration file is text format file saved as xxx.txt.
- b) The registration file name consists of the first three digits and the last five digits of the SN number. The example is as below.



Figure 2.11 Example of Oscar's registration file

#### 2.2.2.4 Configure base or rover

To configure Oscar as a base or rover, back to Device interface which is shown in Figure 2.6 Device functional group, click [Base] or [Rover], then create a work mode of detailed configurations for base or rover which are shown as below.

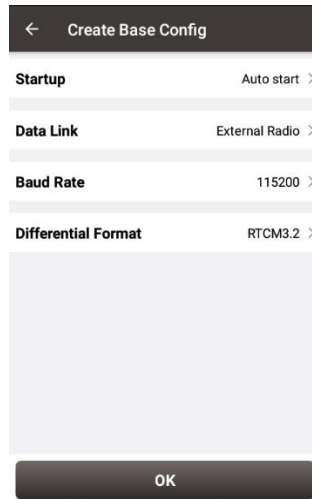

Figure 2.12 Base configuration

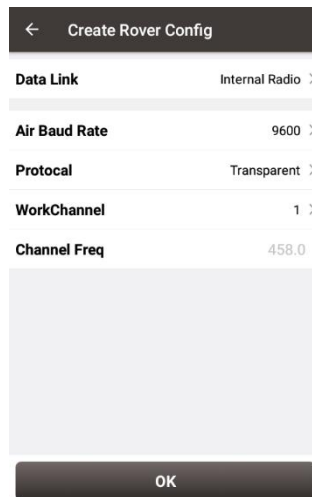

Figure 2.13 Rover configuration

Fill in the detailed information of base configuration or rover configuration, then click [OK] and back to the work mode list, select this configuration to start data transmission for base or rover which are shown as below.

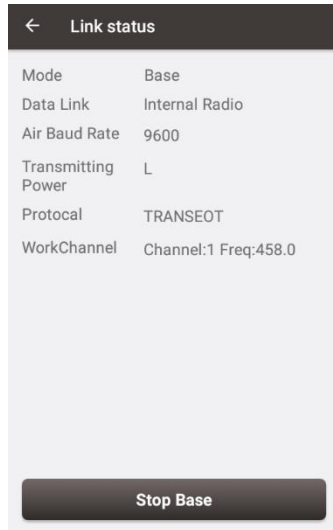

Figure 2.14 Link status of Base

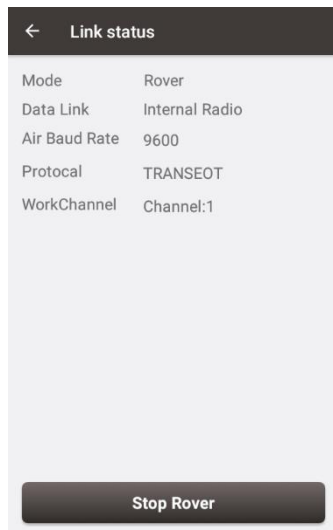

Figure 2.15 Link status of Rover

## 2.3 Data download

### 2.3.1 Connection

Oscar can be used as an USB storage device when connecting with a computer. Before connecting Oscar to a computer, ensure Oscar is powered on. Use the Mini USB cable in the package to connect Oscar to the USB port of a computer which is shown as below.

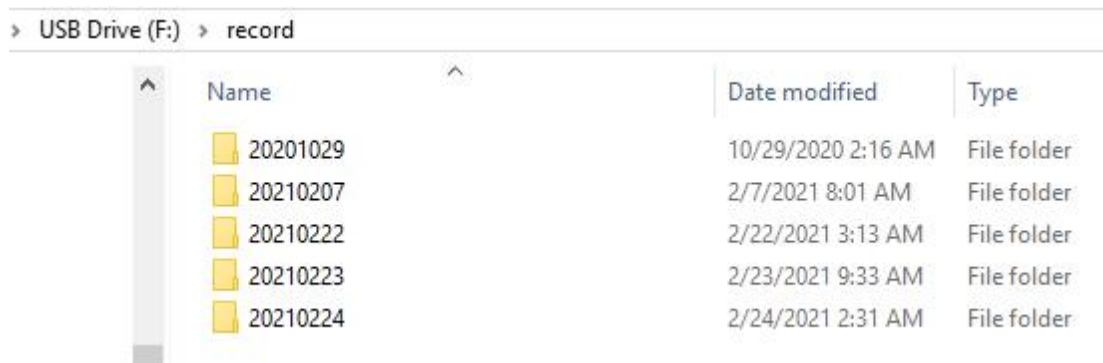

Figure 2.16 Connect Oscar to a computer

After completing the connection, a USB device is listed in the file browser of the computer. Find the data file needed to download, copy and paste it to a designated folder in your computer.

### 2.3.2 Download static data

If you want to download the recorded static data for post processing, find F:\record folder in the USB drive shown as below, and then copy the specific file you need to your computer.



Name	Date modified	Type
20201029	10/29/2020 2:16 AM	File folder
20210207	2/7/2021 8:01 AM	File folder
20210222	2/22/2021 3:13 AM	File folder
20210223	2/23/2021 9:33 AM	File folder
20210224	2/24/2021 2:31 AM	File folder

Figure 2.17 Static record folder

Each folder named after the date contains rinex format and tersus binary data, which can be downloaded and processed as you need.



Name	Date modified	Type
rinex3	2/24/2021 8:32 AM	File folder
trs	2/24/2021 10:13 AM	File folder

Figure 2.18 Static data for one day

### 2.3.3 Download debug data

When you don't turn on the debug mode, find F:\debug\LOG folder and you can see rtkmain.log file which includes all the operation information of the receiver.



Name	Date modified	Type
rtkmain.log	2/24/2021 8:19 PM	Text Document

Figure 2.19 rtkmain.log file location

Turn on debug mode using the FN and power button on the Oscar panel (Oscar Ultimate and Advanced only), find [Device Info] -> [Debug Mode], select the debug info you want to record and turn on the debug mode. The

debug information includes GNSS, tilt, internal radio and NTRIP information. After you select some debug info to turn on and confirm, Oscar will record them when you are doing survey work. Send these debug info to Tersus technical support team to help solve the problems you encountered.

> USB Drive (F:) > debug

Name	Date modified	Type
GNSS	2/24/2021 8:09 PM	File folder
INNER	10/28/2020 8:27 AM	File folder
LOG	2/23/2021 9:13 AM	File folder
NTRIP	2/24/2021 7:41 AM	File folder
RADIO	2/24/2021 7:42 AM	File folder
TILT	2/8/2021 6:42 AM	File folder

Figure 2.20 Debug info folders

If your Oscar hardware version is 2 in [Device Info] -> [GNSS INFO] -> [Hardware], you can click [Device Info] -> [Disk Management] -> [Download Log] on Oscar panel or click [Device] -> [Device Log] -> [Flush] in Nuwa app, then download inner data of the GNSS board in the F:\debug\INNER folder on your computer for issue debugging.

## 2.4 Firmware upgrade

You have two methods to upgrade firmware for Oscar GNSS receiver: wired upgrade and wireless upgrade.

### 2.4.1 Wired upgrade

The detailed steps of Oscar wired upgrade are as follows.

#### 1) View Oscar firmware version.

When Oscar GNSS receiver is powered on, to connect Oscar, put controller near the NFC logo on Oscar, the controller pair Bluetooth with Oscar automatically; or click [Device] -> [Connect] under an opened project, and select [Oscar] for the Device Type, select [Bluetooth] for the Connect Type. Click [Connect Config] to search and pair the Bluetooth address of Oscar. The antenna is selected as [Oscar] by default. Then click [Connect] to enable the communication between controller and Oscar.

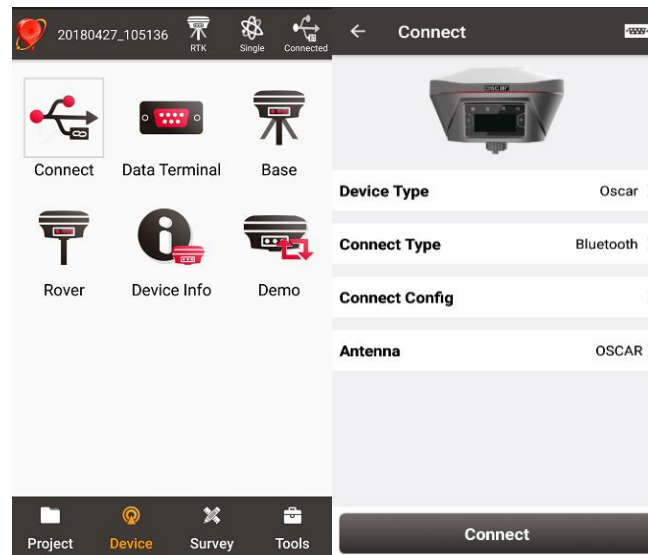

Figure 2.21 Connect to Oscar via Bluetooth

Click the device information icon  on the top tool bar of Nuwa, the Oscar info is shown as below. You can view Oscar firmware version.

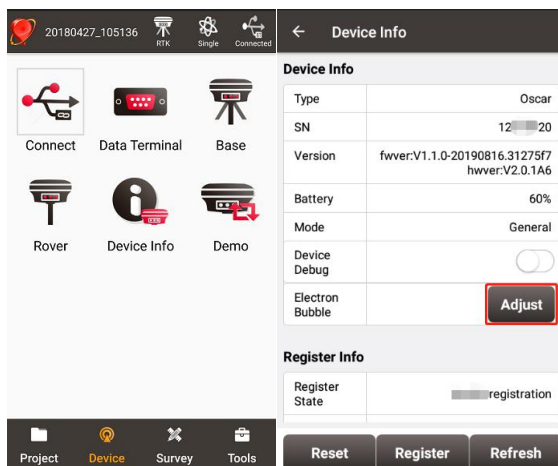

Figure 2.22 View Oscar firmware version

For Ultimate and Advanced versions, you can also check the firmware version by switching the button. In the [device information] -[GNSS information]- [firmware version], you can view the firmware version of the GNSS board inside Oscar. In the [device information] - [software version], you can view Oscar firmware version.

2) Download the latest firmware file from Tersus website <https://www.tersus-gnss.com/software/oscar-gnss-receiver>.

If your Oscar firmware version is V1.2.x or previous versions, it is needed to upgrade to V1.3.1 firmware first, and then upgrade to the latest firmware. V1.3.1 firmware needs to download the specific upgrade package that is designated for your Oscar version (Ultimate/Advanced/Basic), as shown below. Please be noted that the downloaded file is a .zip file, unzip this file to find a PDF document and the firmware file of .GZ format, **DO NOT** unzip the firmware file further.

	Oscar Firmware	Firmware Upgrade	<a href="#">Release Note</a>	2021-05-26/Version:2.0.0
	Oscar Ultimate Firmware	Firmware Upgrade	<a href="#">Release Note</a>	2020-07-23/Version:1.3.1
	Oscar Advanced Firmware	Firmware Upgrade	<a href="#">Release Note</a>	2020-07-23/Version:1.3.1
	Oscar Basic Firmware	Firmware Upgrade	<a href="#">Release Note</a>	2020-07-23/Version:1.3.1

Figure 2.23 V1.3.1 firmware upgrade package download



If your Oscar firmware version is V1.3.0 or later, download the latest upgrade package only. Please be noted that the downloaded file is a .zip file, unzip this file to find the firmware file of .BIN format.

3) Prepare a USB flash drive, ensure the file system of this drive is **FAT32**. Create a folder named "**OscarUpdate**" under the root directory of the USB flash drive, then put the latest firmware file in it . Make sure there is only **one** firmware file in this folder.

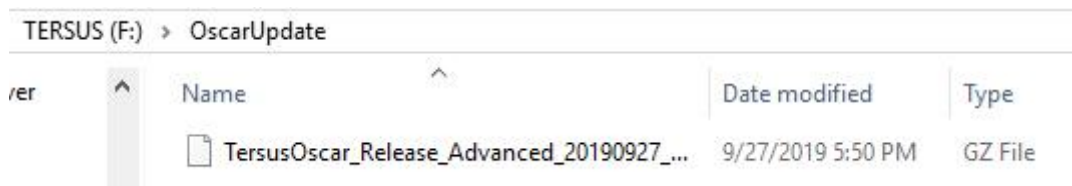

Figure 2.24 Copy the .GZ firmware file to a USB flash drive

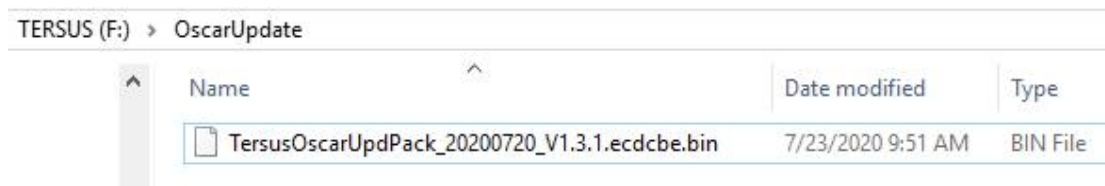

Figure 2.25 Copy the .BIN firmware file to a USB flash drive

4) Ensure Oscar is powered off, and use the Mini-USB OTG cable to connect Oscar to the USB flash drive.



Figure 2.26 Connect Oscar to a USB flash drive

5) If the current firmware version of your Oscar is earlier than V1.4.0 (not included), the firmware upgrade program will automatically start after boot up; If your Oscar firmware version is V1.4.0 or later, it is needed to follow the steps below.

Steps for Ultimate and Advanced versions:

Press and hold the power button and the FN button at the same time. When the TERSUS icon appears on the LED panel, release the power button. Only hold down the FN button and keep pressing the FN button until the LED panel displays "SYSTEM UPGRADE". Release the FN button and wait for the upgrade. "SYSTEM UPGRADE" means starting to upgrade the firmware, "SYSTEM REBOOT" means the receiver starts to restart automatically, please wait for this process until the LED panel displays the operation interface, as shown in the figure below.



Figure 2.27 The LED panel displays the operation interface

After the LED panel displays the operation interface, you can check whether the Oscar firmware upgrade is successful. Refer to step 1 to check the Oscar firmware version. If it is consistent with the latest firmware version in the USB flash drive, it means the firmware upgrade is successful.

Steps for Basic version:

Press and hold the power button and the FN button at the same time, release the power button when the six indicators on the LED panel are all on. Only hold down the FN button and keep pressing the FN button until the six indicators on the LED panel are all on again. Release the FN button and wait for the upgrade. After the firmware upgrade is completed, the power LED light is on and the satellite light flashes. At this time, refer to step 1 to check the Oscar firmware version. If it is consistent with the latest firmware version in the USB flash drive, the firmware upgrade is successful.

**Note:** Please make sure the battery has enough power for the firmware upgrade. The GNSS board inside Oscar will upgrade when the firmware is upgrading, any forced power failure will cause the system crash.

### 2.4.2 Wireless upgrade

You have two methods for wireless upgrade: one is using web upgrade via Wi-Fi, the other is using Nuwa app via PDA network.

The details are to be updated. Stay tuned for the new version of this user manual.

## 2.5 Web UI

Oscar GNSS receiver supports being a Wi-Fi hotspot and connect with a computer or a smart terminal within five meters. You can read coordinate information, configure the receiver and upgrade the firmware through the web UI (user interface) on the browser of the computer or the smart terminal.

Follow below steps to enter the web user interface on a computer with Windows 10 operating system.

- a. Upgrade the receiver to the latest firmware, and then open Wi-Fi . For Advanced and Ultimate versions, you can open WiFi through switching the power button and the FN button, [Device Info]--[WiFi:OFF] --select [WiFi: AP]--Confirm. SSID & IP & MAC will be automatically set. Please refer to 1.3.1 for detailed button function.



Figure 2.28 Open WiFi (Advanced and Ultimate versions)

For Basic version, you can use controller to connect the receiver via NFC or Bluetooth, please refer to 2.2.2.1 to get detailed connection. Click [Data Terminal], input 'tersusbkdoor' in the below text box and then click the button [Clear]. Next delete 'tersusbkdoor' and input 'wificfg ap' in the below text box. Next click the button [Send], 'send command successfully' will appear after finishing all above operations.

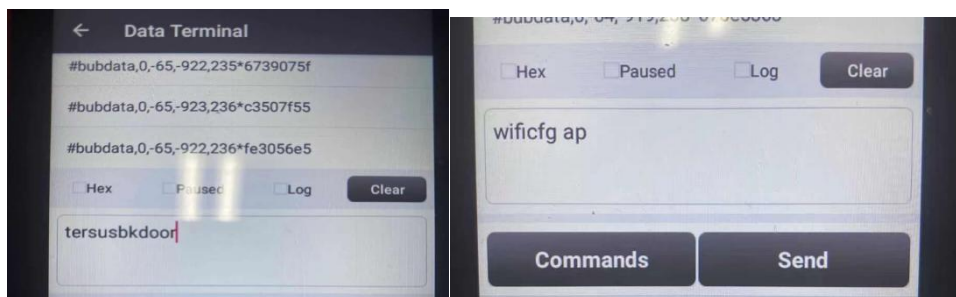

Figure 2.29 Open WiFi (Basic version)

- b. Click the Internet connection icon on the lower right corner of the desktop. Turn on Wi-Fi connection and search the SSID of Oscar GNSS receiver which is composed of TersusGNSS and an eight digit number such as below. Click [Connect] to complete the Wi-Fi connection.

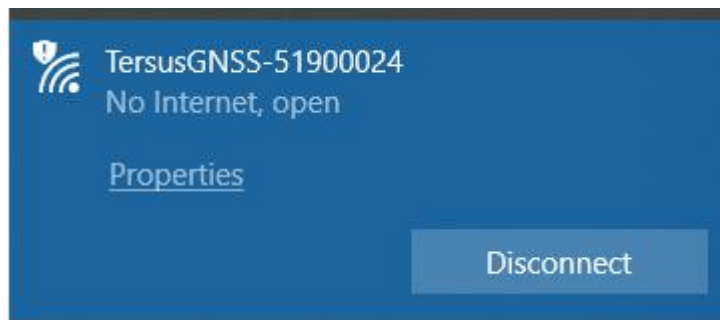

Figure 2.30 Make Wi-Fi connection

- c. Open a web browser and type 192.168.2.1 in the address bar. Type “admin” for the username and password, then click [Sign in] to enter the web UI.

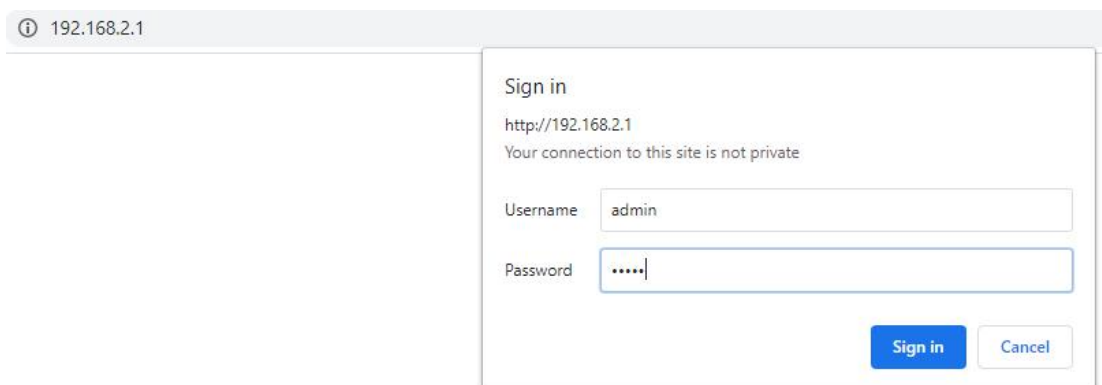

Figure 2.31 Sign in the web UI

- d. When you entered the web UI of Oscar GNSS receiver, you can see five tabs on the left and make corresponding operations such as view positioning info, view satellites info, make device settings, make connectivity settings, and upgrade firmware. [Satellites Info] - [Position Info] - view position information.

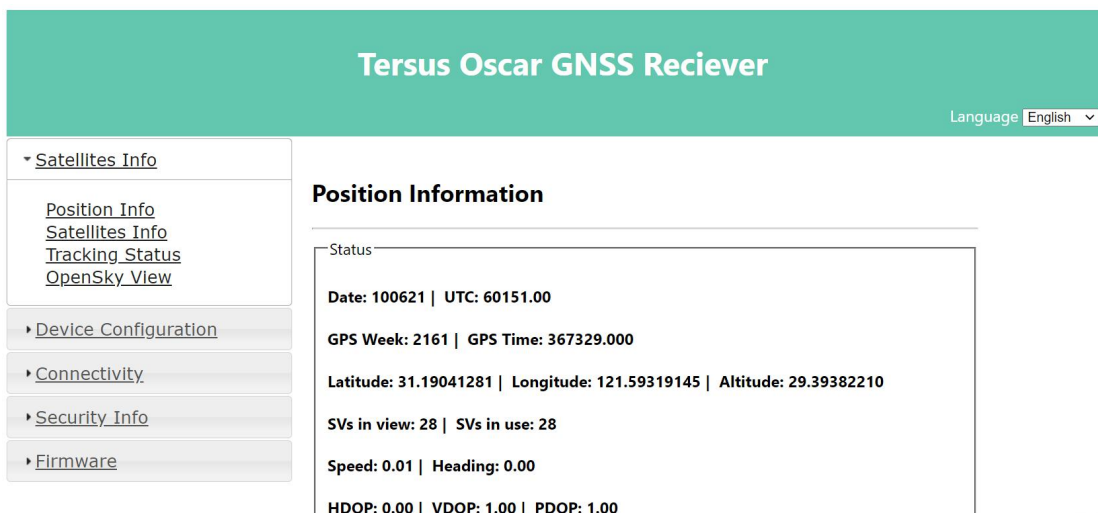

Figure 2.32 Main interface of Oscar’s web UI

e. configure the working mode and related parameters of the equipment .  
 [Device Configuration] - [Mode Configuration] - select working mode - next - next - set.

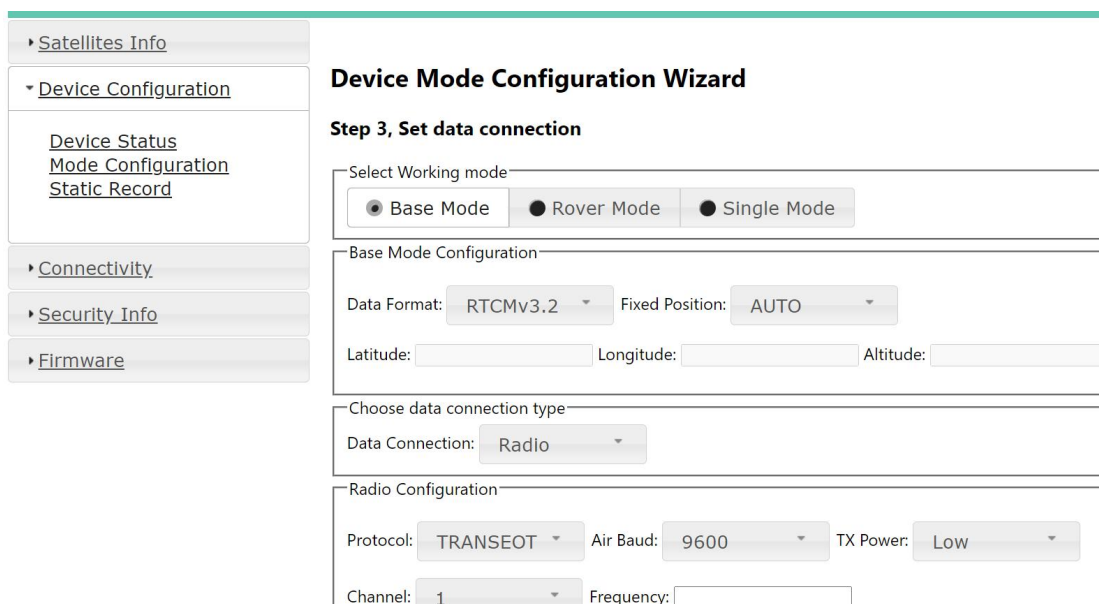

figure 2.33 configure a working mode

f. upgrade device firmware version via web page. [Firmware] - [Firmware Info] - [Firmware Upgrade] - click 【选择文件】 - click [upgrade].  
 you can use this function to upgrade after the next official version is released.

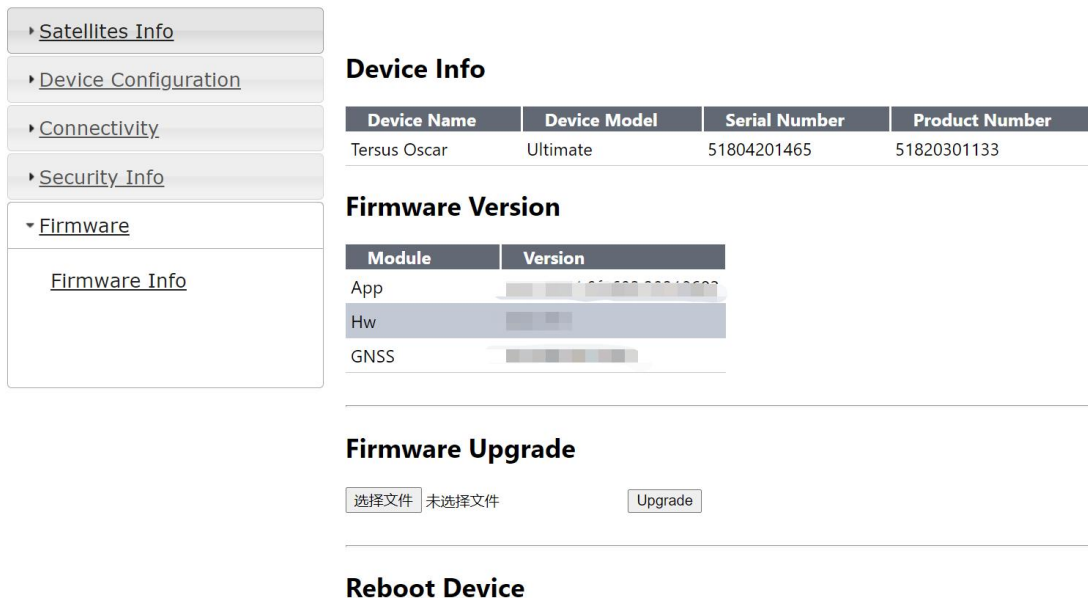

figure 2.34 upgrade the firmware

g. manage user logins through web pages.

[Security Info] - [Account Info] - [Add User] - [Add User Dialog] - input Login Name&Alias Name&Password.

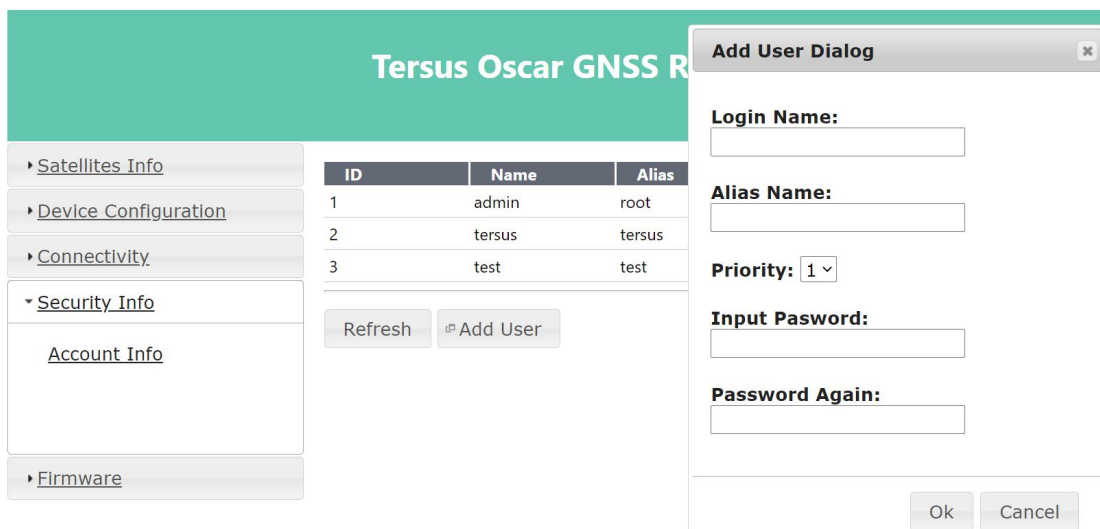

figure 2.35 add user login



## 2.6 Operations of TC20 controller

### 2.6.1 Insert SIM card and Micro SD card

1. **Remove the back cover:** Loosen the screws on the back side - to rotate the screws anti-clockwise until open the back cover shown as below.



Figure 2.36 Remove the back cover

2. **Take off the back cover:** Remove the back cover by lifting it up from the bottom part shown as below.



Figure 2.37 Take off the back cover

3. **Put the SIM card in the holder:** Put the SIM card into the slot touching the SIM contacts of the phone shown as below.



Figure 2.38 Put the SIM card in the holder

4. **Insert Micro SD card:** Open Micro SD card holder and insert Micro SD card into the slot, then close Micro SD card holder shown as below.



Figure 2.39 Insert Micro SD card

5. **Insert the back cover:** Insert the back cover and rotate screws clockwise to lock the back cover shown as below.



Figure 2.40 Insert the back cover

***Note: Please power off the phone before plug in or pull out the SIM card.***

## 2.6.2 Micro SD Card

1. Connect USB, turn on USB storage.

It automatically pops up USB connected interface after connecting USB, and then click “Turn on USB storage” to use the Micro SD as USB storage.

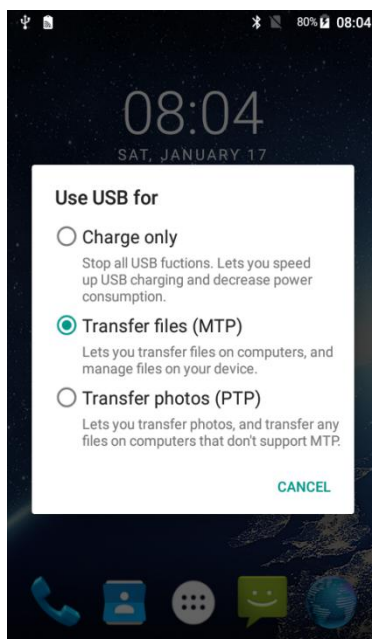

Figure 2.41 Select USB function

### 2.6.3 Using of touch screen

**Single click:** To select an icon. For example, click dial to open the keypad which will be displayed on the screen.

**Double click:** To zoom-in or zoom-out. For example, to zoom-in or out of a photo, click twice when viewing a photo or browsing on the internet.

**Hold:** Click and hold the screen, icon or input box to get more operation options.

- a) Long-time click a picture in the gallery list interface, the status bar prompts to select a picture, you select to share or delete.
- b) Long-time click the blanks of home screen to add home screen shortcut.
- c) Long-time click the blanks of home screen wallpaper sources can be selected.

**Drag the screen:** You can drag the screen to view more applications which are not displayed in one screen.

**Scratch the screen:** A screen of information cannot be displayed, scratch scrolling display the hidden information.

**Stylus pen:** you can use stylus pen for the touch screen after turning on the function via Settings -> Accessibility -> Handwriting Pen.

## 3. Technical Specifications

This chapter mainly introduces the technical specifications of Oscar GNSS receiver, TC20 Controller and external radio.

### 3.1 Oscar GNSS receiver

Table 3.1 Oscar GNSS receiver performance

GNSS Performance		
Position accuracy, RMS	Single Point Positioning	1.5m (Horizontal)
		3.0m (Vertical)
	DGPS Positioning	0.4m (Horizontal)
		0.8m (Vertical)
	High Precision Static	3mm+0.1ppm (Horizontal)
		3.5mm+0.4ppm (Vertical)
	Static & Fast Static	3mm+0.5ppm (Horizontal)
		5mm+0.5ppm (Vertical)
	Post Processed Kinematic	8mm+1ppm (Horizontal)
		15mm+1ppm (Vertical)
Real Time Kinematic	8mm+1ppm (Horizontal)	
	15mm+1ppm (Vertical)	
Network Real Time Kinematic	8mm+0.5ppm (Horizontal)	
	15mm+0.5ppm (Vertical)	
Observation accuracy (zenith direction)	C/A code	15cm
	P code	20cm
	Carrier phase	1mm
Time To First Fix (TTFF)	Cold start	<35s
	Warm start	<10s
Reacquisition	<1s	
Tilt compensation accuracy (within 30°)	≤2cm	
Timing accuracy (RMS)	20ns	
Velocity accuracy (RMS)	0.03m/s	
Initialization (typical)	<10s	
Initialization reliability	>99.99% for Ultimate, >99.9% for Advanced and Basic	
System & Data		
Operating system	Linux	
Storage	built-in 16GB/8GB	
Data format	CMR, CMR+ (GPS only), RTCM 2.X/3.X	

Data output	RINEX, NMEA-0183, Tersus Binary	
<b>Software Support</b>		
Tersus Nuwa, MicroSurvey FieldGenius		
<b>Communication</b>		
Cellular	4G LTE/TD-SCDMA/WCDMA/GPRS/GSM	
Cellular bands (EU version)	FDD LTE B1/B2/B3/B4/B5/B7/B8/B20 WCDMA B1/B2/B5/B8 GSM/GPRS 1900/1800/900/850MHz	
Network protocols	Ntrip Client, Ntrip Server, Tersus Caster Service (TCS)	
Wi-Fi	802.11b/g	
Bluetooth	4.1	
Internal radio	RF transmit power	0.5W/1W/2W
	Frequency	410MHz ~ 470MHz
	Operating mode	Half-duplex
	Channel spacing	12.5KHz / 25KHz
	Modulation type	GMSK, 4FSK
	Air baud rate	4800/9600/19200 bps
	Distance (typical)	>5km
	Radio protocols	TrimTalk450, TrimMark 3, South, Transparent, Satel
USB OTG	USB 2.0 x1	
Serial ports	RS232 x1	
COM baud rate	Up to 921600bps	
<b>Electrical</b>		
Input voltage	+9 ~ 28V DC	
Power consumption	Network or radio receive mode	≈ 5W
	Radio transmit mode (0.5W)	≈ 8W
	Radio transmit mode (1W)	≈ 9W
	Radio transmit mode (2W)	≈ 11W
Lithium battery	7.4V 6400mAh x2	
<b>Physical</b>		
Display	1.54" OLED for Ultimate & Advanced versions	
Dimension	157*157*103 mm	
Weight	≈ 1.2kg (without battery), ≈ 1.4kg (with a battery)	
Screw hole for assembly	5/8"x11UNC-2B	
<b>Environmental</b>		
Operating temperature	-40°C to +70°C	
Storage temperature	-55°C to +85°C	
Relative humidity	100% not condensed	
Water & dust proof	IP68	
Pole drop onto concrete	2m	

The pin definition's view from outside to the serial port is as below.

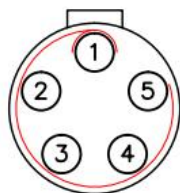

Figure 3.1 Serial data port of Oscar

Table 3.2 Pin definition of the serial data port

Connector Pin No.	Pin Definition
1	GND
2	GND
3	PWR
4	TXD
5	RXD

The pin definition of the TNC connector is as below:

Table 3.3 Pin definition of the TNC connector

Connector Pin No.	Pin Definition
Inside	Signal
Outside	Ground

The pin definition of the battery contacts is as below:

Table 3.4 Pin definition of the battery contacts

Connector Pin No.	Pin Definition
1	+ Positive
2	Data
3	Clock
4	- Negative

Table 3.5 Default factory configuration for internal radio

Channel	Frequency
00	457.550MHz
01	458.050MHz
02	458.550MHz
03	459.050MHz
04	459.550MHz

05	460.550MHz
06	461.550MHz
07	462.550MHz
08	463.550MHz
09	464.550MHz
Customized frequency	410~470MHz

Table 3.6 Detailed configuration information for internal radio

Protocol	Modulation type	Channel band	Air baud rate	COM baud rate
TrimTalk450	GMSK	12.5 KHz	4800 bps	9600/19200/38400/115200bps
	GMSK	25 KHz	9600 bps	9600/19200/38400/115200bps
TrimMark3	GMSK	50 KHz	19200 bps	9600/19200/38400/115200bps
Transparent	GMSK	12.5 KHz	4800 bps	9600/19200/38400/115200bps
	GMSK	25 KHz	9600 bps	9600/19200/38400/115200bps
Satel	4FSK	12.5 KHz	9600 bps	9600/19200/38400/115200bps
	4FSK	25 KHz	19200 bps	9600/19200/38400/115200bps
South	GMSK	12.5 KHz	4800 bps	9600/19200/38400/115200bps
	GMSK	25 KHz	9600 bps	9600/19200/38400/115200bps
	GMSK	50 KHz	19200 bps	9600/19200/38400/115200bps

## 3.2 TC20 controller

Table 3.7 TC20 technical specification

System	
Operating system	Android 6.0
CPU	MTK MT6735 Quad-Core 1.3GHz
Memory	2GB RAM + 16GB ROM
External flash	Micro SD , up to 64GB
Keypad backlight	White
Display	4.3" capacitive touch screen



Resolution	480x800
Camera	8M pixel, auto focus
Flash light	High light flash LED
Language	47 languages including Chinese, English, Filipino, French, Greek, Italian, Japanese, Korean, Malay, Portuguese, Romanian, Russian, Spanish, Thai, Turkish, etc.
<b>GNSS</b>	
Signal tracking	GPS, GLONASS
<b>Communication</b>	
Wi-Fi	IEEE 802.11a/b/g/n/ac
Cellular mode	Dual SIM dual standby
SIM1 & SIM2	FDD-LTE 800 / 1800 / 2100 / 2600MHz TD-LTE 1900 / 2300 / 2500 / 2600MHz WCDMA 850 / 900 / 1900 / 2100MHz GSM 850 / 900 / 1800 / 1900MHz
Bluetooth	V4.1
USB	Micro USB for charging and data (OTG)
Audio Jack	3.5mm Audio Jack for audio
NFC	Standard
Sensors	G-sensor, Compass, Barometer, Light-sensor, Gyro
<b>Electrical</b>	
Power	5V DC, 1.0A
Battery	3.7V 6500mAh
Battery life	10 hours operation, 720 hours standby
Charging time	4.5 hours (5V 2A input), 8 hours (5V 1A input)
<b>Physical</b>	
Dustproof & Waterproof	IP68
Shock	0.8m drop onto concrete
Dimension	210mmx87mmx31mm
Weight	495g (include battery)
Operating temperature	-20 °C ~ +55 °C
Storage temperature	-30 °C ~ +65 °C

### 3.3 External radio for Oscar

Table 3.8 External radio RS400H2 technical specification

General Specification		
Frequency range	410~470MHz	
Operating mode	Simplex	
Channel width	25KHz, 12.5KHz	
Modulation type	GMSK	
Operating voltage	DC 9~16V	
Power consumption	High power (25W)	75W @ DC 12V
	Low power (5W)	35W @ DC 12V
	Standby	1.5W @ DC 12V
Frequency stability	≤ ±1.0ppm	
Transmitter		
RF output power	High level (25W)	44.0±0.5dBm @ DC 12V
	Low level (5W)	37.5±1dBm @ DC 12V
Power stability	±1dBm	
Adjacent channel power	>50dB	
Antenna		
Antenna impedance	50 ohm	
Antenna interface	TNC female	
Modem		
Air baud rate	4800bps, 9600bps, 19200bps	
Modulation type	GMSK	
Serial port baud rate	9600bps, 19200bps, 38400bps, 57600bps, 115200bps	
Protocol	TrimTalk450, TrimMark 3, South, Transparent, SATEL	
Environmental		
Temperature	Operating	-40 ~ +65°C
	Storage	-55 ~ +85°C
Dustproof and waterproof	IP68	
Physical Description		
Dimension	186 x 140 x 73 mm	
Weight	About 1.5kg	
Data & power interface	LEMO 5pin	
Installation	Hook	
Mechanical Drawing		

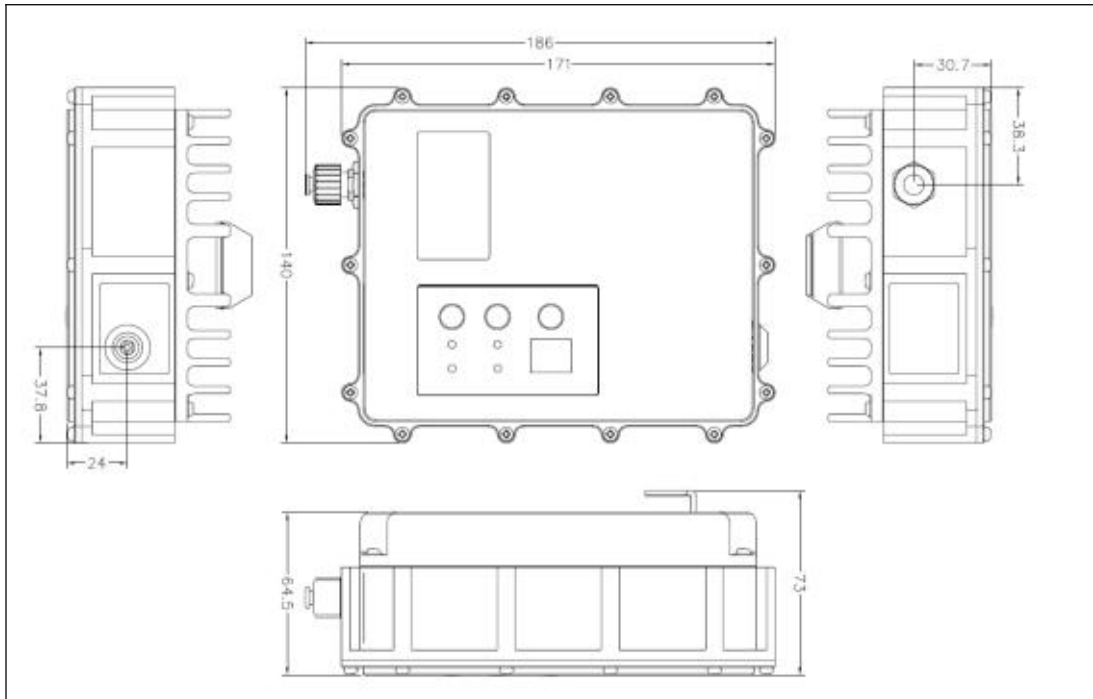

**Signal Definition**

Data & power interface	<p>View from outside to radio</p>	<p>Pin 1: PWR (9~16V DC) current&lt;7A          Pin 2: Power GND          Pin 3: RXD          Pin 4: Signal GND          Pin 5: TXD</p>
------------------------	-----------------------------------	---

Table 3.9 Default factory configuration for Radio RS400H2

Channel	Frequency
1	458.050MHz
2	458.550MHz
3	459.050MHz
4	459.550MHz
5	460.550MHz
6	461.550MHz
7	462.550MHz
8	463.550MHz

## 4. Typical Applications

This chapter introduces typical applications of Oscar GNSS receiver, and solutions for some possible issues.

	<p>Install the radio antenna before switching the radio transceiver to transmit mode, or the radio transceiver may be damaged due to overheating. The energy to be transmitted cannot be emitted out without the antenna, which may cause the temperature rise and overheat of the radio module.</p>
---	--

### 4.1 Base station operation



Figure 4.1 Oscar as a base - network mode

Table 4.1 Devices of Oscar as a base network mode

NO.	Device Name
1	Oscar GNSS receiver
2	Height measure accessory
3	GNSS antenna connector
4	Tribrach
5	Tripod

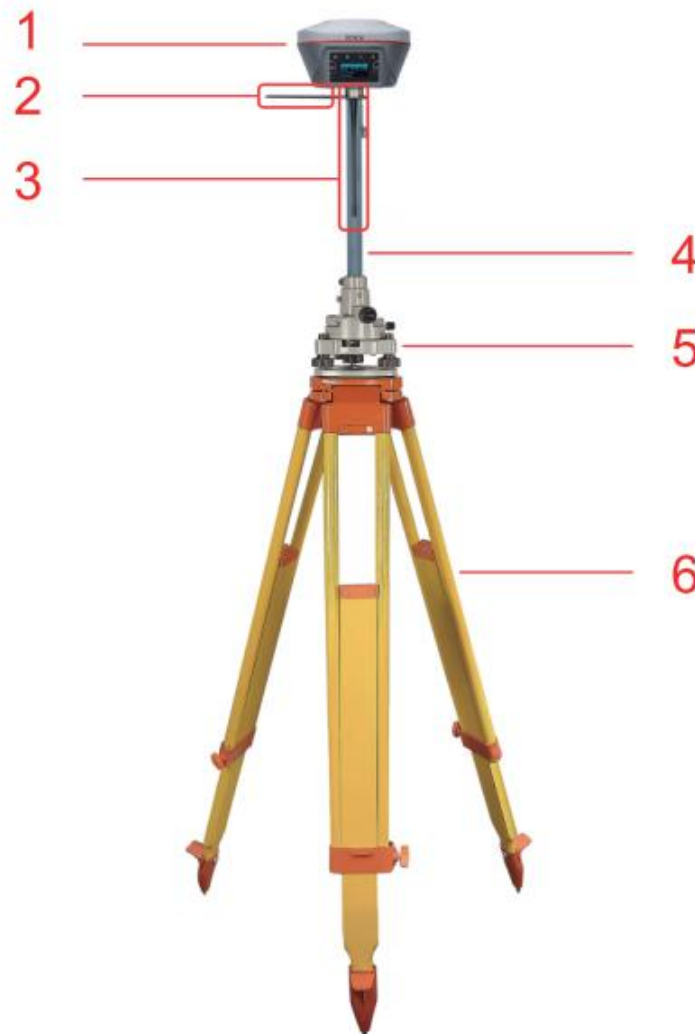

Figure 4.2 Oscar as a base - internal radio

Table 4.2 Devices of Oscar as a base internal radio mode

NO.	Device Name
1	Oscar GNSS receiver
2	Height measure accessory
3	410-470MHz radio whip antenna
4	Extension pole 30cm

5	Tribrach
6	Tripod

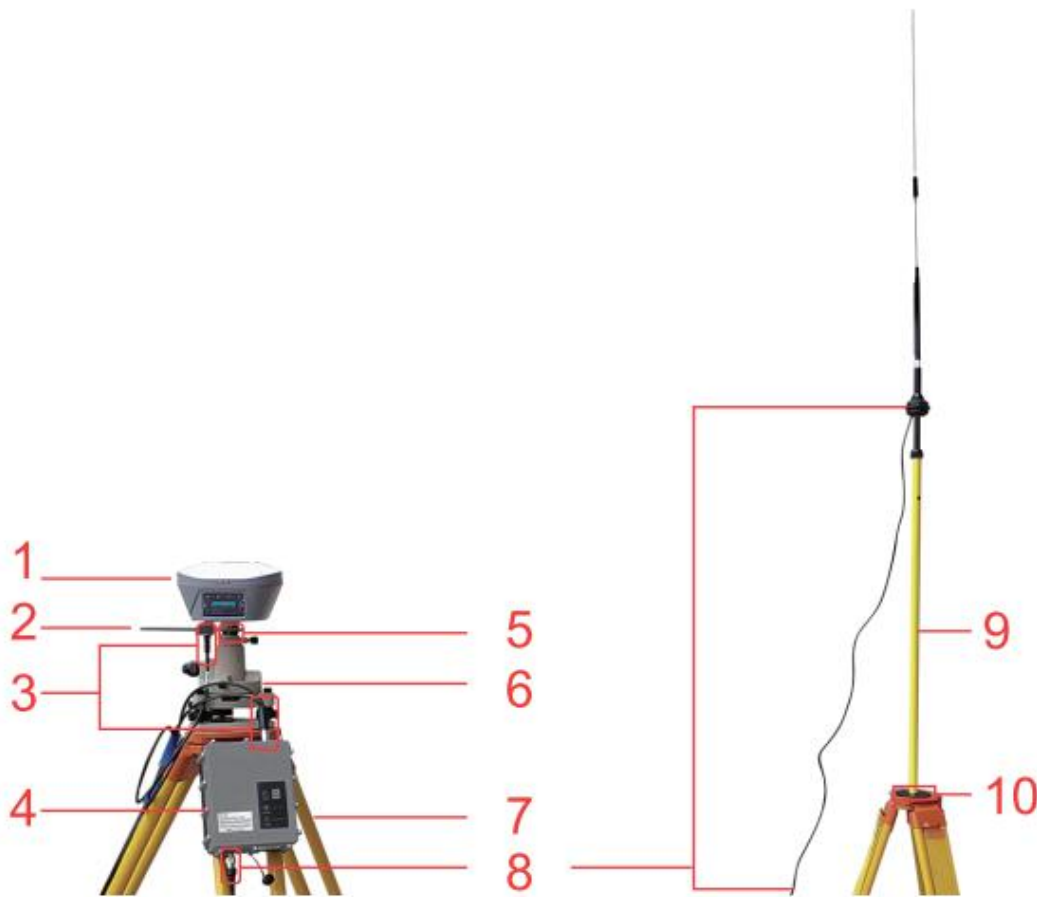

Figure 4.3 Oscar as a base – external radio

Table 4.3 Devices of Oscar as a base external radio mode

NO.	Device Name
1	Oscar GNSS receiver
2	Height measure accessory
3	Serial-5pin to External-Radio-DC-5pin & Bullet-DC
4	External Radio RS400H2
5	GNSS antenna connector
6	Tribrach
7	Tripod
8	High Gain Radio Antenna
9	Telescopic pole for radio antenna
10	Metal plate for radio antenna

**Note: Bullet-DC connects to ‘Bullet-DC to Alligator Clips’, and then clip to**

**the external power supply with 12V output.**

Detailed steps of button operation:

1. Set up Oscar according section 2.1 Setting up Oscar after all the components above are ready, ensure one battery is installed in Oscar and insert one SIM card when 4G/3G/2G network is required for operation;
2. Long press the power button to power on Oscar;
3. Press FN button to select [Mode Config], press the power button to enter the work mode options;
4. Select [Base Mode] and press the power button;
5. If using Tersus Caster Service, select [TCS] and press the power button to enter TCS network settings; Set the format, server and press the power button to confirm.
6. If using internal radio, select [Internal Radio] and press the power button to enter radio setting; Set protocol, format, power, channel, frequency and press the power button to confirm.
7. If using external radio, select [External Radio] and press the power button to configure; Set Baud rate as 115200, format and press the power button to confirm.
8. Above all, setting Oscar as a base is completed.

Detailed steps of software operation:

1. Set up Oscar according section 2.1 Setting up Oscar after all the components above are ready, ensure one battery and one SIM card are installed in Oscar;
2. Long press power button to power on Oscar;
3. Use NFC function to launch Nuwa app. While the screen of TC20 Controller is unlocked, put TC20 Controller close to the Oscar NFC logo.

The Bluetooth pairs automatically after a beep and Nuwa is launched requesting to open the latest project. Click [OK] and start configuring Oscar from step 7. Also you can click [Cancel] to create a new project or open an existing project, and then start configuring Oscar from step 7.

4. If using an android device without NFC function, ensure Oscar is powered on, and launch Nuwa application on the android device. Click [Project] in the main interface to create a new project or open an existing project and connect Oscar manually.
5. Back to the main interface of Nuwa app, click [Device] -> [Connect] under an opened project.
6. Select [Oscar] for the Device Type, select [Bluetooth] for the Connect Type, click [Connect Config] to search and pair the Bluetooth address of Oscar, select [Oscar] for the Antenna and click [Connect] to enable communication between the android controller and Oscar.
7. Back to [Device] - > [Base], click [New] to create a new configuration for base.

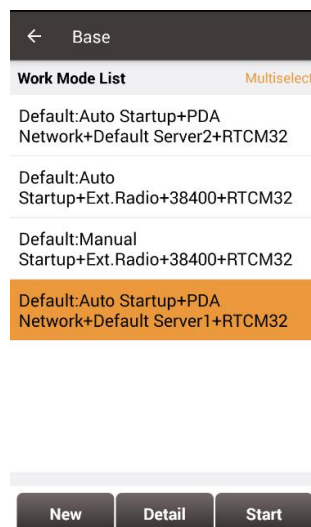

Figure 4.4 Base setting interface

8. Edit the base configuration for Oscar GNSS receiver. The startup mode



can be chosen from auto start and manual start. If you choose manual start the base, you can manually type the base coordinate, or click the location icon to obtain the current base coordinate, or select a point from the control point library. The data link has four options: Receiver Network, PDA Network, Internal Radio and External Radio. Both the Receiver Network and PDA Network have three protocol options: Tersus Caster Service (TCS), Ntrip and TCP.

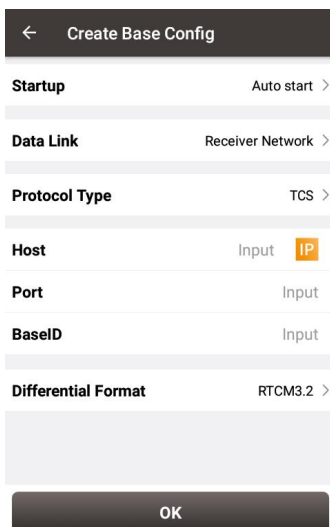

Figure 4.5 Base configuration - Receiver Network (TCS)



Figure 4.6 Base configuration – PDA Network (Ntrip)

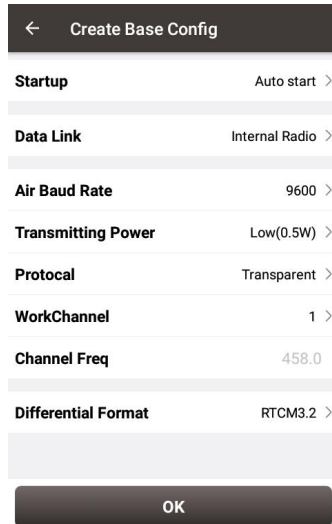

Figure 4.7 Base configuration - Internal Radio

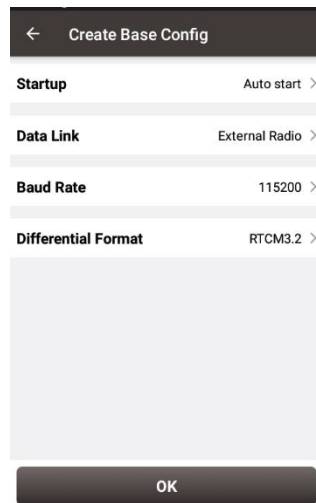

Figure 4.8 Base configuration - External Radio

- After filling the information for the above configuration, click [OK]. Select this configuration in the work mode list and click [Start] to start data transmission for base which is shown as below.

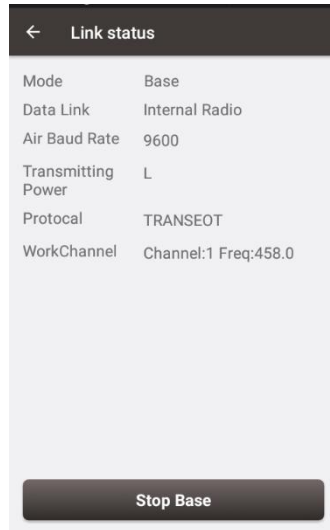

Figure 4.9 Link status of base using internal radio

## 4.2 Rover operation



Figure 4.10 Oscar as a Rover - Network Mode

Table 4.4 Devices of Oscar as a rover network mode

NO.	Device Name
1	Oscar GNSS receiver
2	Ranging pole
3	Bracket for TC20
4	TC20 Controller



Figure 4.11 Oscar as a Rover - Internal Radio

Table 4.5 Devices of Oscar as a rover internal radio mode

NO.	Device Name
1	Oscar GNSS receiver
2	410-470MHz radio whip antenna
3	Bracket for TC20
4	Ranging pole
5	TC20 Controller

Detailed steps of button operation:

1. Set up Oscar according section 2.1 Setting up Oscar after all the components above are ready, ensure one battery and one SIM card are

- installed in Oscar;
2. Long press the power button to power on Oscar;
  3. Press FN button to select [Mode Config], press the power button to enter the work mode options;
  4. Select [Rover Mode] and press power button;
  5. If using Tersus Caster Service, select [TCS] and press the power button to enter TCS network settings; Set the Base ID, server and press the power button to confirm.
  6. If using internal radio, select [Internal Radio] and press the power button to enter radio setting; Set protocol, channel and frequency same as Base, press the power button to confirm.
  7. If using NTRIP Client, select [NTRIP Client] and press the power button to enter NTRIP setting; set IP address with correct port and press the power button to confirm.
  8. Above all, setting Oscar as a rover is completed.

#### Detailed steps of software operation:

1. Set up Oscar according section 2.1 Setting up Oscar after all the components above are ready, ensure one battery and one SIM card are installed in Oscar;
2. Long press the power button to power on Oscar;
3. Use NFC function to launch Nuwa app. While the screen of TC20 Controller is unlocked, put TC20 Controller close to the Oscar NFC logo. The Bluetooth pairs automatically after a beep and Nuwa is launched requesting to open the latest project. Click [OK] and start configuring Oscar from step 7. Also you can click [Cancel] to create a new project or open an existing project, and then start configuring Oscar from step 7.
4. If using an android device without NFC function, ensure Oscar is powered

on, and launch Nuwa application on the android device. Click [Project] in the main interface to create a new project or open an existing project and connect Oscar manually.

5. Back to the main interface of Nuwa app, click [Device] -> [Connect] under an opened project;
6. Select [Oscar] for the Device Type, select [Bluetooth] for the Connect Type, click [Connect Config] to search and pair the Bluetooth address of Oscar, select [Oscar] for the Antenna and click [Connect] to enable communication between the android controller and Oscar.
7. Back to [Device] - > [Rover], click [New] to create a new configuration for base.

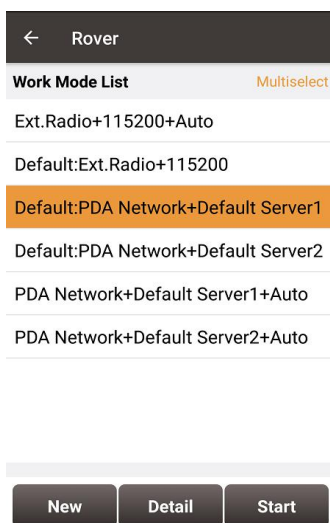

Figure 4.12 Rover setting interface

8. Edit rover configuration for Oscar GNSS receiver under different data link selections. The Receiver Network and PDA Network have three protocol options respectively: Ntrip, TCP and Tersus Caster Service (TCS).

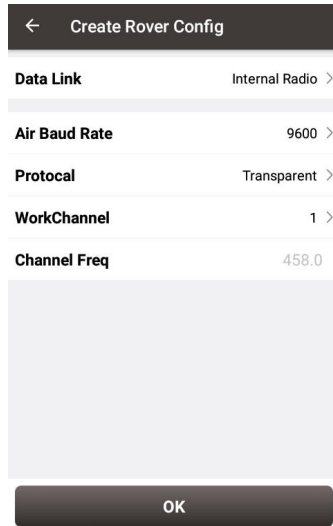

Figure 4.13 Rover configuration - Internal Radio

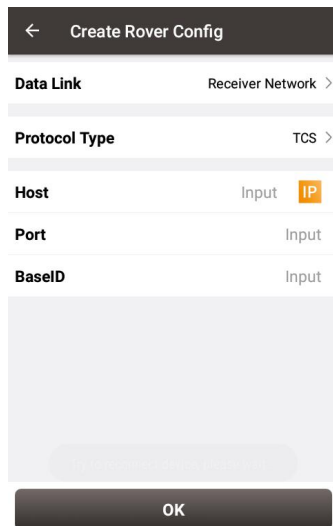

Figure 4.14 Rover configuration - Receiver Network (TCS)



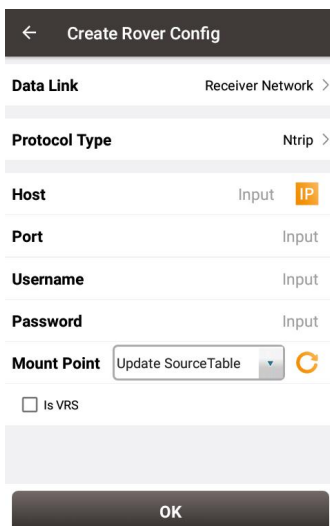

Figure 4.15 Rover configuration - Receiver Network (Ntrip)

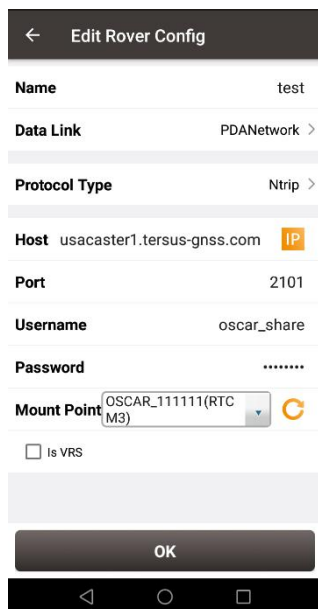

Figure 4.16 Rover configuration - PDA Network (Ntrip)

**Note: Select PDANetwork when using cellular or Wi-Fi network of a PDA such as TC20 Controller.**

9. After filling the information for the above configuration, click [OK]. Select this configuration in the work mode list and click [Start] to start data transmission for rover which is shown as below.

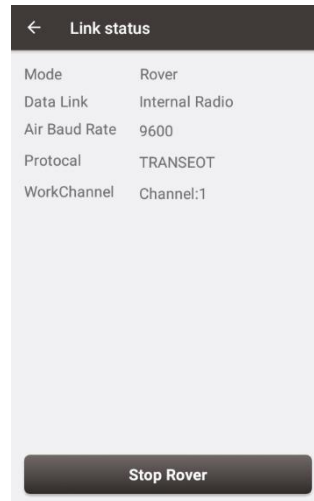

Figure 4.17 Link status of Rover using internal radio

### 4.3 Static survey

Before performing static survey, ensure one battery is installed in Oscar GNSS receiver.

Detailed steps of button operation:

1. Long press the power button to power on Oscar;
2. Press FN button to select [Mode Config], press the power button to enter the work mode options;
3. Select [Static: OFF] and press the power button to enter configuration options for static survey;
4. Set Frequency, Mask Elevation, Duration, Antenna Height, Measure Type, Data Format and RINEX Format;
5. Turn on static when the cursor is on 'STATIC: OFF', then it becomes 'STATIC: ON', press the power button to confirm;
6. Above all, setting static survey is completed.

Detailed steps of software operation:

1. Long press the power button to power on Oscar;
2. Use NFC function to launch Nuwa app. While the screen of TC20 Controller is unlocked, put TC20 Controller close to the Oscar NFC logo. The Bluetooth pairs automatically after a beep and Nuwa is launched requesting to open the latest project. Click [OK] and start configuring Oscar from step 6. Also you can click [Cancel] to create a new project or open an existing project, and then start configuring Oscar from step 6.
3. If using an android device without NFC function, ensure Oscar is powered on, and launch Nuwa application on the android device. Click [Project] in the main interface to create a new project or open an existing project and connect Oscar manually.
4. Back to the main interface of Nuwa app, click [Device] -> [Connect] under an opened project;
5. Select [Oscar] for the Device Type, select [Bluetooth] for the Connect Type, click [Connect Config] to search and pair the Bluetooth address of Oscar, select [Oscar] for the Antenna and click [Connect] to enable communication between the android controller and Oscar.
6. Click [Survey] -> [Static Survey], fill in the parameters of interval, cutoff angle, and etc. Then click [Start] to start static survey.

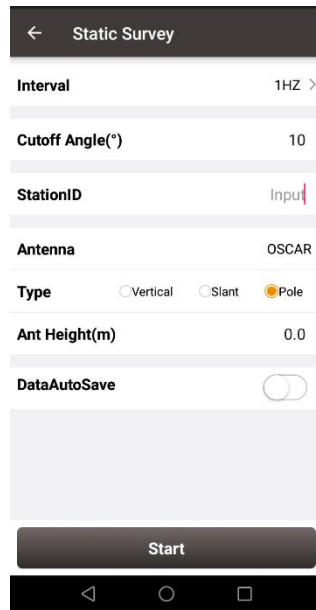

Figure 4.18 Static Survey configuration

7. If the DataAutoSave function is turned on, the static data is recorded automatically in the internal storage when power up Oscar next time. You can download data file refer to section 2.3.

## 4.4 Tilt survey and stakeout

Tilt function is only applicable for Oscar GNSS receiver Ultimate version under rover mode.

### 4.4.1 Tilt initialization

The tilt compensation of Oscar GNSS receiver Ultimate version is free of complex calibration. The tilt compensation will be initialized when the surveyor walks forward naturally for several meters after turning on the tilt compensation function. You can start tilt survey right after you walk to the survey point.

There are two methods to turn on or off tilt compensation. One is turning on or off tilt compensation on Device Info on the OLED via buttons. Another method is through Nuwa app. After the Oscar GNSS receiver Ultimate version is connect in Nuwa app, and we configure it working as a Rover. Click the device icon  on the top or click [Device] under the device functional group to enter the device information interface. Turn on the [Tilt Enable] on the device interface.

When tilt function is turned on, the tilt LED on the Oscar Ultimate OLED display lights on with steady red, a few seconds later it starts flashing red. At this time, walk a few steps ahead, tilt the pole at any direction, then the tilt LED turns steady green which indicates tilt compensation is valid. Now you can start tilt survey.

When the tilt compensation is valid, click the Satellite info icon to view the detailed information of tilt compensation including tilt status, tilt direction, tilt angle, heading and their quality index. Among them, the tilt direct indicates

which direction is tilted, that is, the angle between the projection of the ranging pole on the ground and the north direction after tilting; the tilt angle indicates the degree of tilt, that is, the angle between the tilted pole and the vertical direction; Heading indicates the surveyor's orientation (the facing of Oscar's back, we consider Oscar's panel is always facing the surveyor).



Figure 4.19 Detailed information of tilt compensation

#### 4.4.2 Tilt survey

After turning on [Tilt Enable] and tilt initialization is finished, enter Survey interface and start tilt survey.

The tilt status is displayed at the top of the survey interface. When the tilt status is ON, it is considered that the tilt compensation accuracy is high and it is in a usable state. You can start survey using the tilted ranging pole. Please ensure that the antenna height setting is correct which will affect the tilt measurement results.

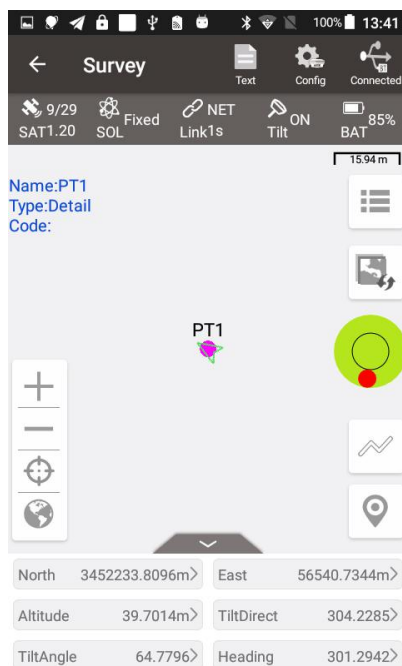

Figure 4.20 Tilt status is ON

When the status is displayed as N/A and blinking, it is considered that the accuracy of tilt compensation is reduced and it is in a state that is not recommended. At this time, the tilt indicator of the Oscar Ultimate OLED display turns flashing red. This may be caused by the surveyor standing for too long, rotating the ranging pole, or hitting the ranging pole to the ground. When the status is N/A, you need to redo the initialization. Generally, you do not need to stand still, just hold the ranging pole and walk forward to the next point, the initialization is complete automatically.

**Note:** during the tilt survey, please keep the Oscar OLED display facing the surveyor as much as possible. Please do not rotate the pole or hit the pole to the ground, which will invalidate the initialization or affect the accuracy of the tilt compensation. In addition, during the tilt point survey, if it does not continue at the third epoch reached when it is set smoothing 5 epochs for surveying points, please check whether the tilt compensation is invalid. It is not allowed to continue to complete the survey in the case where the tilt initialization accuracy is low.

### 4.4.3 Tilt stakeout

After turning on [Tilt Enable] and tilt initialization is finished, enter the Point Stakeout or Line Stakeout interface and start tilt stakeout. The tilt state is also added at the top of the stakeout interface to indicate the current tilt available state.

During the tilt stakeout process, if you enter the threshold range of the stakeout setting, the software will display a virtual tilt ranging pole along with the beep sounds. It is drawn according to the tilt direction angle. When the pole is tilted in a certain direction among east, west, south and north, the virtual tilt ranging pole on the interface will also tilt in a certain direction.

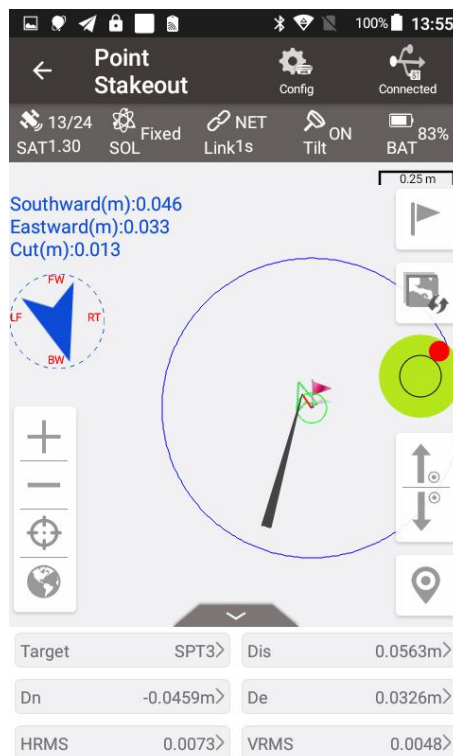

Figure 4.21 Point stakeout when tilt compensation is on



## 4.5 Issues and solutions

This section lists possible issues and effective solutions to solve them. Please read this section before contacting Tersus technical support.

1. Oscar GNSS receiver cannot receive satellite signals.

**Solution:**

- (1) Change the survey environment, and restart Oscar in an open space.
- (2) Reset the GNSS module by pressing and holding the FN button, continuously tapping the power button 5 times.

2. The internal UHF radio does not transmit data.

**Solution:**

- (1) Check whether the receiver is searching satellites normally;
- (2) Check whether the 2W/460MHz radio antenna is installed properly;
- (3) Check whether the radio module's protocol and channel are configured correctly and consistent with the configuration of rover's radio.

3. CORS network is not able to be logged in.

**Solution:**

Check whether the 4G SIM card is properly installed, and whether it can be used normally.

4. The communication between Nuwa and Oscar fails.

**Solution:**

- (1) Check whether the Oscar is powered on;
- (2) Re-search and pair the Bluetooth;
- (3) Upgrade Nuwa to the latest version.

5. There is no correction data for rover when using Ntrip work mode.

**Solutions:**

- (1) Check whether the IP address, port, user name, password is correct;
- (2) Check network. Try to use PDA/controller network to compare. Make sure there is no issue on the contact between the SIM card slot and the SIM card.
- (3) Obtain the SourceTable to check the receiver network module, ensure there is no issue on CORS service.
- (4) Try to log in with the same configuration and get a compared result if there is an extra receiver.
- (5) If still cannot log in, consult your CORS service provider.

6. How to export static observation data from Oscar?

**Solutions:**

- (1) Connect Oscar receiver with a computer through a mini USB cable.
- (2) The computer detects the Oscar receiver as an external disk.
- (3) Open the Record folder, find the trs file and rinex file in its storage according to recording date.
- (4) Copy the static observation data and paste them to the designated folder in your computer.

7. How to calibrate the E-Bubble of Oscar receiver?

**Solutions:**

- (1) Firstly, install Oscar receiver on the tribrach of a tripod. Adjust the tribrach to enable the bubble to the center.
- (2) Next step, select <Adjust> in the Nuwa under Device Info -> E-Bubble to complete the calibration.

8. How to apply Geoid model file correctly?

**Solutions:**

- (1) Prepare the Geoid file at first and placed in the path of Internal storage\TersusSurvey\Geoid.
- (2) Next step, launch Nuwa and go to select Project - Current Project and edit Coordinate System. Find the Height Fitting-Adjust Method and select Geoid.
- (3) Last, select the file under Geoid List and apply it.

9. How to configure Oscar serial port output NMEA log?

**Solutions:**

There are two ways to realize the NMEA sentences output which you'd like to.

- (1) Nuwa can configure to output NMEA by the NMEA option. It can be specified the Baud Rate, the kind of sentence.
- (2) Variable bonus, it can be directly configured on the panel. NMEA can be turned on through Device Info -> Serial.

10. A base receiver is working well, the rover receiver cannot get correction data, how to fix this?

**Solutions:**

- (1) Check whether the radio antenna connects well with receiver. Carefully check whether the interface is tightened.
- (2) Check whether the air baud rate, Protocol, Bandwidth, Frequency match right with that of the base receiver.
- (3) Switchover the radio frequency to avoid the possible interference from nearby devices.

11. The Oscar rover works at a short distance (not normal distance) at the radio mode?

**Solutions:**

- (1) Check whether the rover connects a radio antenna.
- (2) Adjust the radio of base at the high power gear.
- (3) Check the environment if there exists radio interference along the propagation line.

## 5. Terminology

<b>Abbreviation</b>	<b>Description</b>
AC	Alternating Current
BDS	BeiDou Navigation Satellite System
CMR	Compact Measurement Record
DC	Direct Current
eMMC	Embedded Multi Media Card
GLONASS	GLObal NAVigation Satellite System
GNSS	Global Navigation Satellite System
GPS	Global Positioning System
GSM	Global System for Mobile Communications
LED	Light Emitting Diode
OLED	Organic Light-Emitting Diode
PDA	Personal Digital Assistant
PPK	Post-Processing Kinematic
PPS	Pulse Per Second
QZSS	Quasi-Zenith Satellite System
RINEX	Receiver Independent Exchange format
RMS	Root Mean Squares
RTK	Real-Time Kinematic
RTCM	Radio Technical Commission for Maritime Services
SIM	Subscriber Identification Module
TCP	Transmission Control Protocol
UAV	Unmanned Aerial Vehicle, drone
UMTS	Universal Mobile Telecommunications System
USB	Universal Serial BUS
UTC	Universal Time Coordinated

**Proprietary Notice**

All Information in this document is subject to change without notice and does not reflect the commitment on Tersus GNSS Inc. No part of this manual may be reproduced or transmitted by all means without authorization of Tersus GNSS Inc. The software described in this document must be used in terms of the agreement. Any modification without permission from Tersus GNSS Inc. is not allowed.