

User Manual

Version V1.6-20200103



User Manual For Nuwa App

©2020 Tersus GNSS Inc. All rights reserved.

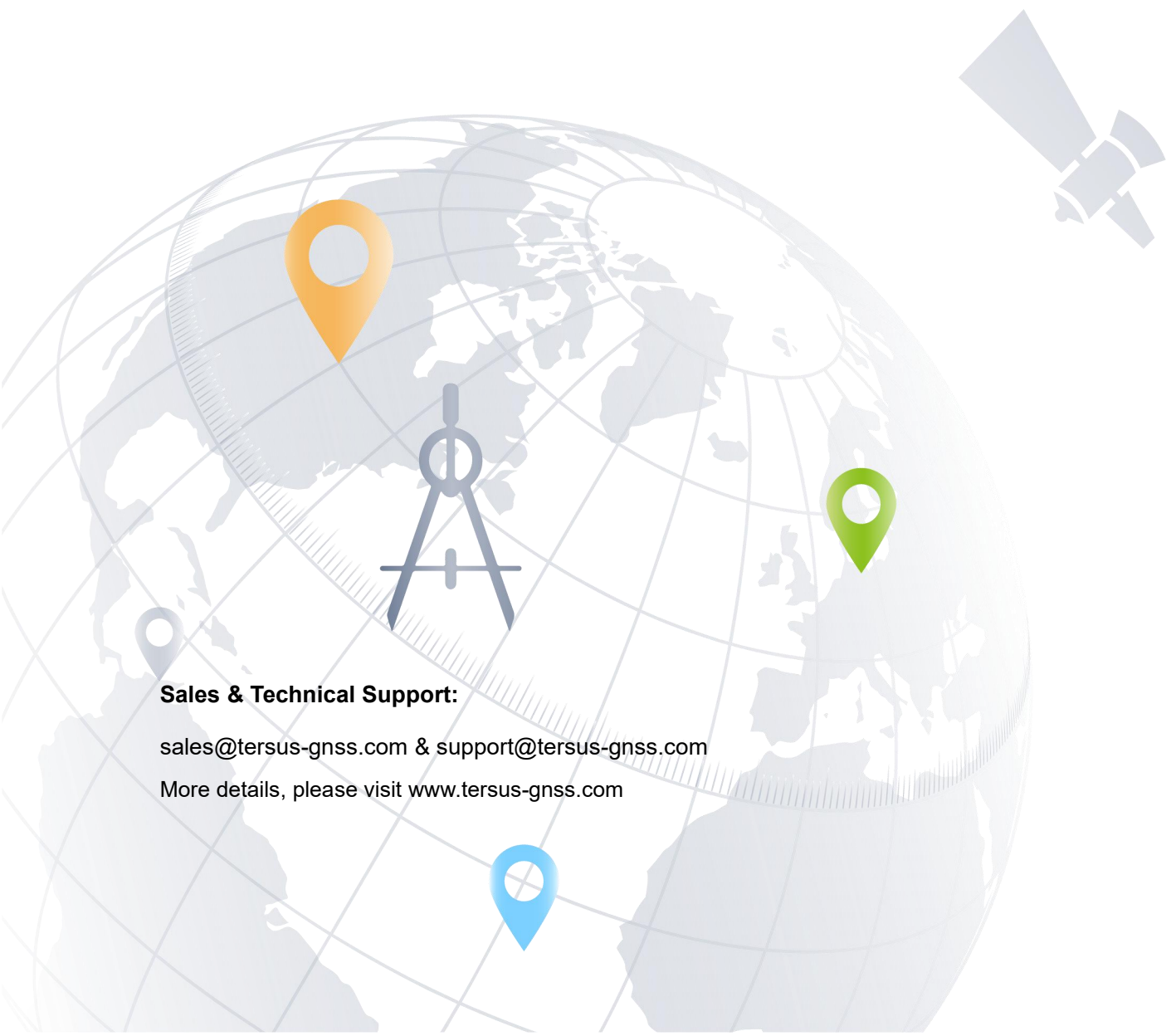

Sales & Technical Support:

sales@tersus-gnss.com & support@tersus-gnss.com

More details, please visit www.tersus-gnss.com

Revision History

| Revision | Description | Date | Owner |
|----------|--|------------|-------|
| 1.0 | Issued for Release | 2018/08/08 | LC |
| 1.1 | Added detailed description for device info and satellite info interfaces. Added predefined CRS for users to import Added Geoid CRS option Update section 4.7 Base Shift Added chapter for TC20 controller Added section 7.4 Issues and Solutions Other minor changes and fixes | 2018/12/28 | LC |
| 1.2 | Updated section 1.2 Installation; Added section 1.3 Update Nuwa; Updated cover photo; Updated section 7.2.2 File Downloading and section 7.2.3 Data Post Processing | 2019/04/03 | LC |
| 1.3 | Updated section 3.1 Connect | 2019/05/29 | LC |
| 1.4 | Updated screenshots in section 2.2 and 4; Added Oscar configuration in section 3.3 & 3.4; Added electronic bubble in section 3.5, 4.1 to 4.3; Updated section 5.2 to Azimuth Distance; Updated pictures in section 6.3 & 6.4 TC20 controller. Updated section 4.1 adding linework function. | 2019/11/06 | LC |
| 1.5 | Updated section 2.2.5 adding plane grid; Added SIMA format for import and export; Updated linework function for continued linework; Updated line stakeout function; Added report file function for detail point acquisition; Added L5 SNR display; Added display button for electronic bubble. | 2019/12/02 | LC |
| 1.6 | Added static record duration for static survey; Added NMEA output for Oscar; Added Point On Line Staking for line stakeout. | 2020/01/03 | LC |

Table of Content

| | |
|----------------------------------|-----|
| Revision History..... | ii |
| Table of Content..... | iii |
| List of Figures..... | vii |
| 1. Nuwa Brief Introduction..... | 1 |
| 1.1 Introduction..... | 2 |
| 1.2 Installation..... | 3 |
| 1.3 Update Nuwa..... | 5 |
| 1.4 Main Interface..... | 7 |
| 2. Project..... | 12 |
| 2.1 Project..... | 13 |
| 2.1.1 New..... | 13 |
| 2.1.2 Import..... | 14 |
| 2.1.3 Open..... | 15 |
| 2.1.4 Delete..... | 15 |
| 2.1.5 Edit Project Property..... | 16 |
| 2.2 CRS (CooRdinate System)..... | 17 |
| 2.2.1 New CRS..... | 18 |
| 2.2.2 Import CRS..... | 25 |
| 2.2.3 Edit CRS..... | 27 |
| 2.2.4 Delete CRS..... | 27 |
| 2.2.5 Plane Grid and Geoid..... | 28 |
| 2.3 Parameters..... | 30 |
| 2.4 Point..... | 33 |
| 2.4.1 Add Point..... | 33 |
| 2.4.2 Search Point..... | 35 |
| 2.4.3 Edit Point..... | 36 |
| 2.4.4 Import Point..... | 38 |

| | | |
|--------|---------------------------|----|
| 2.4.5 | Delete Point..... | 40 |
| 2.5 | Line..... | 41 |
| 2.5.1 | Add Line..... | 41 |
| 2.5.2 | Search Line..... | 44 |
| 2.5.3 | Edit Line..... | 45 |
| 2.5.4 | Delete Line..... | 47 |
| 2.6 | Import..... | 48 |
| 2.6.1 | Coordinate Import..... | 48 |
| 2.6.2 | Other Import..... | 52 |
| 2.7 | Export..... | 53 |
| 2.7.1 | Coordinate Export..... | 53 |
| 2.7.2 | Other Export..... | 55 |
| 2.8 | Settings..... | 58 |
| 3. | Device..... | 59 |
| 3.1 | Connect..... | 60 |
| 3.2 | Data Terminal..... | 66 |
| 3.3 | Base..... | 69 |
| 3.3.1. | Set David as a Base..... | 70 |
| 3.3.2. | Set Oscar as a Base..... | 74 |
| 3.4 | Rover..... | 76 |
| 3.4.1. | Set David as a Rover..... | 76 |
| 3.4.2. | Set David as a Rover..... | 79 |
| 3.5 | NMEA Output..... | 81 |
| 3.6 | Device Info..... | 82 |
| 4. | Survey..... | 85 |
| 4.1 | Survey..... | 86 |
| 4.2 | Point Stakeout..... | 90 |
| 4.3 | Line Stakeout..... | 92 |
| 4.4 | Static Survey..... | 94 |

| | | |
|-------|--|-----|
| 4.4.1 | Static data download for David..... | 95 |
| 4.4.2 | Static data download for Oscar..... | 99 |
| 4.4.3 | Data post-processing..... | 101 |
| 4.5 | Point Correction..... | 103 |
| 4.5.1 | Four Parameter..... | 104 |
| 4.5.2 | Height Fitting..... | 104 |
| 4.5.3 | Four Parameter + Height Fitting..... | 104 |
| 4.5.4 | Application Example..... | 104 |
| 4.6 | Survey Config..... | 108 |
| 4.6.1 | Common Config..... | 108 |
| 4.6.2 | Display Config..... | 110 |
| 4.7 | Base Shift..... | 111 |
| 5. | Tools..... | 114 |
| 5.1 | Area Perimeter..... | 115 |
| 5.2 | Azimuth Distance..... | 115 |
| 5.2.1 | Point to Point Distance..... | 116 |
| 5.2.2 | Point to Line Distance..... | 116 |
| 5.3 | Offset Point..... | 117 |
| 5.4 | Rotation Point..... | 118 |
| 5.5 | Two Points Intersection..... | 119 |
| 5.6 | Four Points Intersection..... | 120 |
| 5.7 | Intersection Angle..... | 121 |
| 6. | TC20 Controller and application..... | 122 |
| 6.1 | Overview of TC20 Controller..... | 122 |
| 6.2 | Outlook of TC20 Controller..... | 123 |
| 6.3 | Accessories of TC20 Controller..... | 124 |
| 6.4 | General Operations..... | 125 |
| 6.4.1 | Insert SIM card and Micro SD card..... | 125 |
| 6.4.2 | Micro SD card..... | 128 |

| | |
|----------------------------------|-----|
| 6.4.3 Using of Touch Screen..... | 129 |
| 7. Technical Appendix..... | 130 |
| 7.1 Quick Start..... | 130 |
| 7.2 Issues and Solutions..... | 133 |
| 8. Terminology..... | 136 |
| 9. File Format..... | 137 |

List of Figures

| | |
|---|----|
| Figure 1.1 Nuwa in Google Play Store..... | 3 |
| Figure 1.2 Nuwa in Google Play Store – install..... | 3 |
| Figure 1.3 Nuwa in Google Play Store – open..... | 4 |
| Figure 1.4 Nuwa copied in an android device..... | 4 |
| Figure 1.5 Nuwa icon on desktop..... | 4 |
| Figure 1.6 Update Nuwa in Google Play Store – 1..... | 5 |
| Figure 1.7 Update Nuwa in Google Play Store – 2..... | 5 |
| Figure 1.8 Version in Settings page..... | 6 |
| Figure 1.9 Software Update notification..... | 6 |
| Figure 1.10 Nuwa Main Interface..... | 7 |
| Figure 1.11 Satellite Info – Position..... | 8 |
| Figure 1.12 Satellite Info – Skymap..... | 9 |
| Figure 1.13 Satellite Info – SNR L1..... | 9 |
| Figure 1.14 Satellite Info – LNR L2..... | 10 |
| Figure 1.15 Satellite Info – LNR L5..... | 10 |
| Figure 1.16 Satellite Info – Sat Tab..... | 11 |
| Figure 2.1 Functions under Project..... | 12 |
| Figure 2.2 Create Project interface..... | 13 |
| Figure 2.3 New project created..... | 14 |
| Figure 2.4 Project folders in an Android device..... | 14 |
| Figure 2.5 Sketch file containing the project info..... | 15 |
| Figure 2.6 Open an existing project..... | 15 |
| Figure 2.7 Delete Project..... | 16 |
| Figure 2.8 Project List..... | 16 |
| Figure 2.9 Project Property..... | 17 |
| Figure 2.10 Share Project Info..... | 17 |
| Figure 2.11 Coordinate System List..... | 18 |

| | |
|---|----|
| Figure 2.12 Create a new CRS..... | 18 |
| Figure 2.13 Ellipsoid list..... | 19 |
| Figure 2.14 Projection interface..... | 19 |
| Figure 2.15 Projection list..... | 20 |
| Figure 2.16 Datum transformation options..... | 20 |
| Figure 2.17 Bursa Parameters..... | 21 |
| Figure 2.18 Plane adjustment interface..... | 21 |
| Figure 2.19 Plane adjustment options..... | 21 |
| Figure 2.20 4 Parameters..... | 22 |
| Figure 2.21 Height fitting interface..... | 22 |
| Figure 2.22 Parameters fitting options..... | 22 |
| Figure 2.23 Height Fitting – Parameters Fitting..... | 23 |
| Figure 2.24 Scan QR code to get CRS info..... | 24 |
| Figure 2.25 CRS info obtained by scanning QR code..... | 24 |
| Figure 2.26 Predefined CRS..... | 25 |
| Figure 2.27 Continent options..... | 25 |
| Figure 2.28 Preview of predefined CRS..... | 26 |
| Figure 2.29 Example of CRS import..... | 26 |
| Figure 2.30 Edit Coordinate System..... | 27 |
| Figure 2.31 Delete CRS..... | 27 |
| Figure 2.32 Plane Grid list..... | 28 |
| Figure 2.33 Plane Grid download list..... | 28 |
| Figure 2.34 Geoid list..... | 29 |
| Figure 2.35 Geoid download list..... | 29 |
| Figure 2.36 Explore Geoid folder in the android device..... | 29 |
| Figure 2.37 Refresh to view the Geoid list..... | 30 |
| Figure 2.38 Parameters Calculation..... | 31 |
| Figure 2.39 Add Point for calculation..... | 31 |
| Figure 2.40 Parameters Calculation Result interface..... | 32 |

| | |
|--|----|
| Figure 2.41 Point Interface..... | 33 |
| Figure 2.42 Control Point interface..... | 34 |
| Figure 2.43 Add Control Point..... | 34 |
| Figure 2.44 Import Survey Point..... | 35 |
| Figure 2.45 Control Point interface..... | 35 |
| Figure 2.46 Point Query interface..... | 36 |
| Figure 2.47 Control Point interface..... | 37 |
| Figure 2.48 Edit Control Point interface..... | 37 |
| Figure 2.49 Control Point interface..... | 38 |
| Figure 2.50 Data format list..... | 38 |
| Figure 2.51 Import Data info..... | 39 |
| Figure 2.52 Import source for Stakeout Point..... | 39 |
| Figure 2.53 Import from Survey Point..... | 40 |
| Figure 2.54 Delete Point interface..... | 40 |
| Figure 2.55 Line interface..... | 41 |
| Figure 2.56 Add survey line interface..... | 41 |
| Figure 2.57 Select two points from survey point library – 1..... | 42 |
| Figure 2.58 Select two points from survey point library – 2..... | 42 |
| Figure 2.59 Survey line added..... | 42 |
| Figure 2.60 Survey line in survey interface..... | 43 |
| Figure 2.61 Add stakeout line method 1..... | 43 |
| Figure 2.62 Add stakeout line method 2..... | 44 |
| Figure 2.63 Line Query interface..... | 45 |
| Figure 2.64 Edit a survey line 2..... | 45 |
| Figure 2.65 Add PT5 to the line end..... | 46 |
| Figure 2.66 The new Line2 in survey interface..... | 46 |
| Figure 2.67 Add PT5 before PT6..... | 46 |
| Figure 2.68 The new Line2 in survey interface..... | 46 |
| Figure 2.69 Delete PT5 in Line2..... | 47 |

| | |
|---|----|
| Figure 2.70 Line2 after deleting PT5..... | 47 |
| Figure 2.71 Select a stakeout line..... | 47 |
| Figure 2.72 Edit a stakeout line..... | 47 |
| Figure 2.73 Line interface..... | 48 |
| Figure 2.74 Tick the line to be deleted..... | 48 |
| Figure 2.75 Import interface..... | 49 |
| Figure 2.76 Import Type..... | 49 |
| Figure 2.77 Target Point Library..... | 50 |
| Figure 2.78 Data Format options..... | 50 |
| Figure 2.79 File Format options..... | 51 |
| Figure 2.80 Import Line interface..... | 51 |
| Figure 2.81 Example content in the .Inb file..... | 51 |
| Figure 2.82 Other Import interface..... | 52 |
| Figure 2.83 File Type for other import..... | 52 |
| Figure 2.84 Export Interface..... | 53 |
| Figure 2.85 Data Format options..... | 54 |
| Figure 2.86 User defined data..... | 54 |
| Figure 2.87 Create data format..... | 55 |
| Figure 2.88 Manage data format..... | 55 |
| Figure 2.89 Other Export interface..... | 55 |
| Figure 2.90 File Format for other export..... | 56 |
| Figure 2.91 Export XML file..... | 56 |
| Figure 2.92 Preview of the XML file in text mode..... | 57 |
| Figure 2.93 Settings interface..... | 58 |
| Figure 3.1 Functions under Device..... | 59 |
| Figure 3.2 Device functional group..... | 60 |
| Figure 3.3 Connect interface – David..... | 60 |
| Figure 3.4 Connect interface – Oscar..... | 61 |
| Figure 3.5 Two connection types for David..... | 61 |

| | |
|---|----|
| Figure 3.6 Bluetooth searching..... | 62 |
| Figure 3.7 Bluetooth is pairing..... | 62 |
| Figure 3.8 Bluetooth paired..... | 63 |
| Figure 3.9 Connect interface – Oscar..... | 63 |
| Figure 3.10 Connect interface – NMEA..... | 64 |
| Figure 3.11 Antenna Manage interface..... | 64 |
| Figure 3.12 Parameters for New Antenna..... | 65 |
| Figure 3.13 Antenna parameters explanation..... | 65 |
| Figure 3.14 Data Terminal interface..... | 66 |
| Figure 3.15 Data Terminal outputs hex data..... | 66 |
| Figure 3.16 Create File Name..... | 67 |
| Figure 3.17 Start recording log data..... | 67 |
| Figure 3.18 Stop recording log data..... | 68 |
| Figure 3.19 Common Command..... | 68 |
| Figure 3.20 David base auto start – Radio..... | 70 |
| Figure 3.21 Baud rate options..... | 71 |
| Figure 3.22 David base auto start – Ntrip..... | 71 |
| Figure 3.23 David base auto start – TCP..... | 71 |
| Figure 3.24 Ntrip Site Manager..... | 72 |
| Figure 3.25 David base manual start – Radio..... | 73 |
| Figure 3.26 David base manual Start – Network..... | 73 |
| Figure 3.27 Oscar base auto start – 4 data link options..... | 74 |
| Figure 3.28 Oscar base auto start – internal radio..... | 74 |
| Figure 3.29 Oscar base auto start – receiver network options..... | 75 |
| Figure 3.30 Oscar base auto start – Ntrip network..... | 75 |
| Figure 3.31 Oscar base auto start – TCP network..... | 75 |
| Figure 3.32 Oscar base auto start – TCS network..... | 75 |
| Figure 3.33 Oscar base auto start – PDA network options..... | 76 |
| Figure 3.34 Create Rover Configuration for David – Radio..... | 77 |

| | |
|--|----|
| Figure 3.35 Create Rover Configuration for David – Ntrip Network..... | 77 |
| Figure 3.36 Protocol type options..... | 78 |
| Figure 3.37 Edit Rover Configuration..... | 78 |
| Figure 3.38 Create Rover Configuration for David – TCP Network..... | 79 |
| Figure 3.39 Create Rover Configuration for Oscar – Internal Radio..... | 79 |
| Figure 3.40 Oscar rover data link options..... | 80 |
| Figure 3.41 Oscar rover using receiver network – protocol options..... | 80 |
| Figure 3.42 Oscar rover using PDA network – protocol options..... | 81 |
| Figure 3.43 NMEA output configuration..... | 81 |
| Figure 3.44 NMEA baud rate options..... | 81 |
| Figure 3.45 Device Info interface..... | 82 |
| Figure 3.46 eBubble before adjusting..... | 83 |
| Figure 3.47 eBubble after adjusting..... | 83 |
| Figure 4.1 Functions under Survey..... | 85 |
| Figure 4.2 Survey – Drawing mode..... | 86 |
| Figure 4.3 Survey – Text mode..... | 86 |
| Figure 4.4 Enter an existing line name..... | 88 |
| Figure 4.5 Continue the existing line options..... | 88 |
| Figure 4.6 Information option list – part 1..... | 89 |
| Figure 4.7 Information option list – part 2..... | 89 |
| Figure 4.8 Point Stakeout interface..... | 90 |
| Figure 4.9 Add stakeout point..... | 91 |
| Figure 4.10 Line Stakeout interface..... | 92 |
| Figure 4.11 Enter stakeout line library..... | 92 |
| Figure 4.12 Edit an existing stakeout line..... | 92 |
| Figure 4.13 Static Survey interface..... | 94 |
| Figure 4.14 Duration options..... | 94 |
| Figure 4.15 Static data recording..... | 95 |
| Figure 4.16 Preparation for Static Data Process..... | 96 |

| | |
|--|-----|
| Figure 4.17 Connections of David, computer and power bank..... | 96 |
| Figure 4.18 TersusDownload interface..... | 97 |
| Figure 4.19 Download speed options..... | 97 |
| Figure 4.20 File selected for download..... | 98 |
| Figure 4.21 View antenna height in the RINEX file..... | 99 |
| Figure 4.22 Connect Oscar to a computer..... | 99 |
| Figure 4.23 Static data recorded by Oscar..... | 100 |
| Figure 4.24 Tersus Rinex Converter interface..... | 100 |
| Figure 4.25 The Rinex files after conversion..... | 101 |
| Figure 4.26 TERSUS Geomatics Office interface..... | 101 |
| Figure 4.27 Import Files in TERSUS Geo Office..... | 101 |
| Figure 4.28 Default configuration of the observation data..... | 102 |
| Figure 4.29 Calculation Type options..... | 103 |
| Figure 4.30 Height Fitting options..... | 103 |
| Figure 4.31 Application example for point correction..... | 105 |
| Figure 4.32 Add point for point correction..... | 105 |
| Figure 4.33 The 1 st pair of points for calculation..... | 106 |
| Figure 4.34 The 2 nd pair of points for calculation..... | 106 |
| Figure 4.35 Two pairs of points for calculation..... | 106 |
| Figure 4.36 Calculation Result..... | 107 |
| Figure 4.37 Point correction results applied to current project..... | 107 |
| Figure 4.38 Slide left to view residual results..... | 108 |
| Figure 4.39 Updated project property after point correction..... | 108 |
| Figure 4.40 Survey Config - Detail..... | 109 |
| Figure 4.41 Survey Config – Continuous..... | 109 |
| Figure 4.42 Survey Config – Display Config..... | 110 |
| Figure 4.43 Survey Point Color..... | 111 |
| Figure 4.44 Advanced Config for Display Config..... | 111 |
| Figure 4.45 Base Shift interface – 1..... | 112 |

| | |
|--|-----|
| Figure 4.46 Base Shift interface – 2..... | 113 |
| Figure 5.1 Functions under Tools..... | 114 |
| Figure 5.2 Area Perimeter interface..... | 115 |
| Figure 5.3 Azimuth Distance – Point to Point..... | 116 |
| Figure 5.4 Azimuth Distance – Point to Line..... | 116 |
| Figure 5.5 Offset Point interface..... | 117 |
| Figure 5.6 Offset Point calculation result..... | 117 |
| Figure 5.7 Rotation Point interface..... | 118 |
| Figure 5.8 Rotation Point Calculation result..... | 118 |
| Figure 5.9 Two Point Intersection – Angle..... | 119 |
| Figure 5.10 Two Point Intersection – Distance..... | 119 |
| Figure 5.11 Four Point Intersection interface..... | 120 |
| Figure 5.12 Four Point Intersection result..... | 120 |
| Figure 5.13 Intersection Angle calculation..... | 121 |
| Figure 6.1 Four sides of TC20 controller..... | 123 |
| Figure 6.2 TC20 Lithium battery..... | 124 |
| Figure 6.3 TC20 Charger Adapter..... | 124 |
| Figure 6.4 TC20 Charger Adapter Plugs..... | 124 |
| Figure 6.5 TC20 Controller hand strap..... | 125 |
| Figure 6.6 Stylus Pen for TC20..... | 125 |
| Figure 6.7 Mini USB cable..... | 125 |
| Figure 6.8 Remove the back cover..... | 126 |
| Figure 6.9 Take off the back cover..... | 126 |
| Figure 6.10 Put the SIM card in the holder..... | 127 |
| Figure 6.11 Insert Micro SD card..... | 127 |
| Figure 6.12 Insert the back cover..... | 128 |
| Figure 6.13 Select USB function..... | 129 |

1. Nuwa Brief Introduction

- Introduction
- Installation
- Update Nuwa
- Main Interface

1.1 Introduction

Nuwa is a survey application software based on Android OS (Operating System), designed by and all rights reserved to Tersus Inc. Nuwa is simple, easy to use and has friendly UI (User Interface). It is designed to work with Tersus products including David GNSS receiver, Oscar GNSS receiver, BX series OEM boards and other receivers which support NEMA-0183.

Main features of Nuwa App:

- Supports Bluetooth/USB connection and related operations for Tersus receivers.
- Powerful data management makes survey data management more convenient. Easy for data editing and import / export of several types of formats.
- Convenient to set up a base station or a rover, and supports setting to transmit and receive differential data through the radio, receiver network or PDA network.
- Optimized survey and stakeout, supports GNSS Linework, more functions, and more simple operation.
- Built-in a variety of ellipsoids, projections and various national coordinate systems. Supports user-defined coordinate system which is more adaptable.
- Provide tools for indirect measurement for easier work.
- Supports new release detection and online upgrades.

1.2 Installation

There are two methods of installing Nuwa app in an android device.

- 1) Search Nuwa in Google Play Store, click [Install], install the application and open it after the installation is completed. The screenshots are as follows.

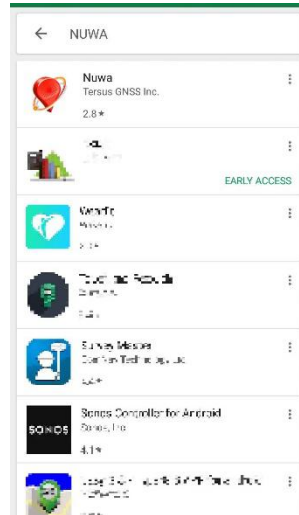

Figure 1.1 Nuwa in Google Play Store

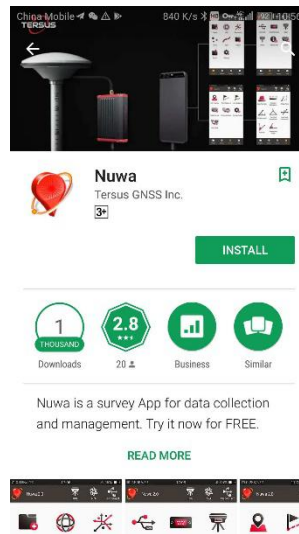

Figure 1.2 Nuwa in Google Play Store – install

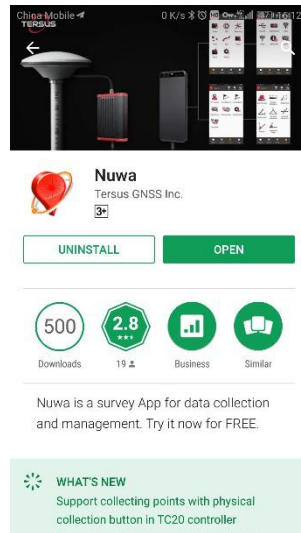

Figure 1.3 Nuwa in Google Play Store – open

- 2) Copy the .apk file to the storage of an Android device, click it to start installation. The Nuwa icon will be on the desktop after it is installed successfully.

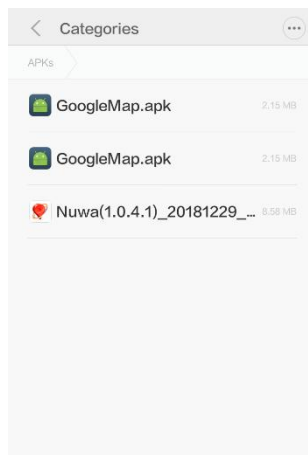

Figure 1.4 Nuwa copied in an android device

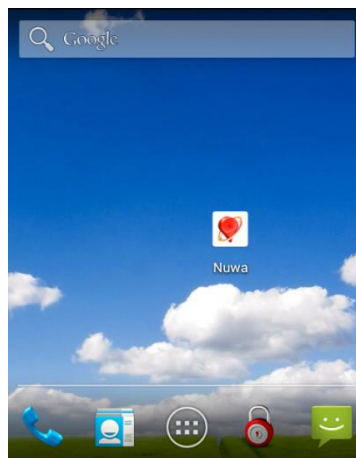

Figure 1.5 Nuwa icon on desktop

1.3 Update Nuwa

There are three methods of updating Nuwa app in an android device.

- 1) Update Nuwa in Google Play Store which is shown below.

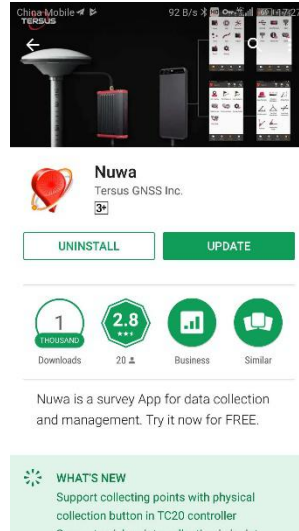

Figure 1.6 Update Nuwa in Google Play Store – 1

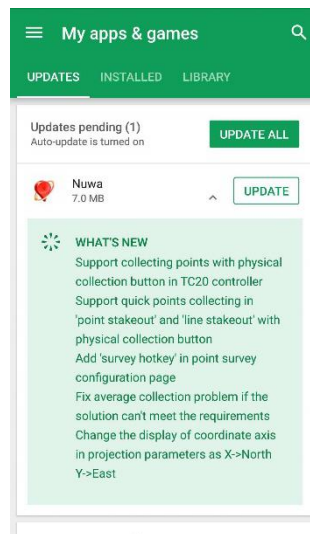

Figure 1.7 Update Nuwa in Google Play Store – 2

- 2) Update Nuwa by copying the latest .apk installation file to the storage of an android device. The process is the same with that in the above section of installation.
- 3) Update Nuwa in the 'Settings' page inside Nuwa app. In the condition that the android device is connected to internet and [Update Detection] is turned on, it automatically pops up an update prompt every time you open Nuwa and it can be seen that there is red 'new' on the right of version number if current Nuwa version is detected to be ready to update.

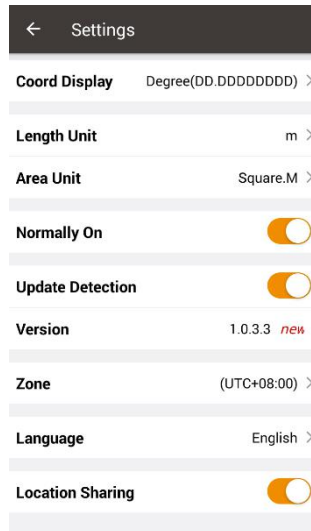

Figure 1.8 Version in Settings page

If [Update Detection] is not turned on, tap the row of version, it pops out a window indicating software update. Select [Update] to update the app automatically. Select [Later] to ignore this notification.

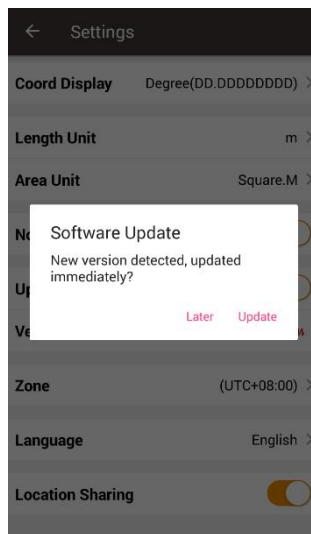

Figure 1.9 Software Update notification

1.4 Main Interface

Nuwa has four main functional groups: Project, Device, Survey and Tools. While Nuwa is running, slide left or right on the screen to enter other functional groups.

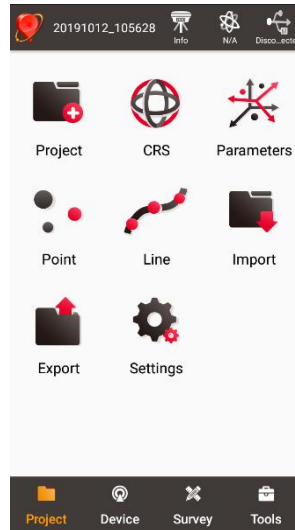



Figure 1.10 Nuwa Main Interface

➤ Status Bar



[]: Project Information, the current project is displayed.



[]: Device information, click it to check details about the receiver connected. Refer to section 3.6 for detailed description.



[]: Satellites status, N/A indicates Not Applicable, satellite positioning status includes: Single, DGPS, Float and Fixed. Click this icon to view satellite information which is shown in the figures below.



[]: Connection status, can be Connected or Disconnected. Click this icon to enter connect interface, refer details in section 3.1.

➤ Menu area

List all the menu items in the current functional group.

➤ Tabs Bar

Four functional groups: Project, Device, Survey and Tools.

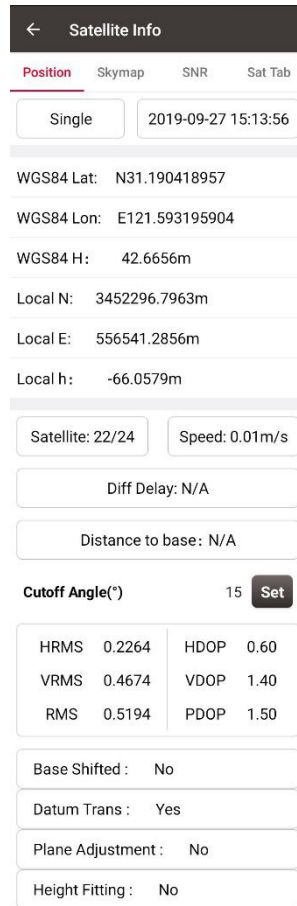

← Satellite Info

Position Skymap SNR Sat Tab

Single 2019-09-27 15:13:56

WGS84 Lat: N31.190418957

WGS84 Lon: E121.593195904

WGS84 H: 42.6656m

Local N: 3452296.7963m

Local E: 556541.2856m

Local h: -66.0579m

Satellite: 22/24 Speed: 0.01m/s

Diff Delay: N/A

Distance to base: N/A

Cutoff Angle(*) 15 Set

| | | | |
|------|--------|------|------|
| HRMS | 0.2264 | HDOP | 0.60 |
| VRMS | 0.4674 | VDOP | 1.40 |
| RMS | 0.5194 | PDOP | 1.50 |

Base Shifted: No

Datum Trans: Yes

Plane Adjustment: No

Height Fitting: No

Figure 1.11 Satellite Info – Position

In the figure above, 'Single' indicates the current solution status of the receiver. The solution status includes Fixed, Float, DGPS, Single, Base Manual and Base Auto.

Clicking the box of date and time can switch time zone, clicking 'WGS84 Lat' or 'WGS84 Lon' can switch display from options of Degree (DD.DDDDDD), DM (DD:MM.MMMM) and DMS (DD:MM:SS.SS), clicking 'WGS84 H' or 'Local N' or 'Local E' or 'Local h' can switch unit from options of km, m, inch, and feet.

'Satellite: 22/24' indicates that 22 satellites used and 24 satellites observed / tracked.

'Speed: 0.01m/s' is the moving speed of the receiving antenna.

'Diff Delay: 1' indicates that the differential delay is 1 second.

'Distance to base: 1.52m' means the distance between rover and base is 1.52m.

Elevation Mask Angle can be set between 0 and 90 degrees. Modifying the elevation mask angle does not show a change in the number of satellites observed and used.

HRMS, VRMS and RMS indicate the horizontal, vertical and total value of root mean square.

HDOP, VDOP and PDOP indicate the horizontal, vertical and position of dilution of precision.

The last four rows of this interface present the status of base shift, datum transformation, plane adjustment and height fitting.

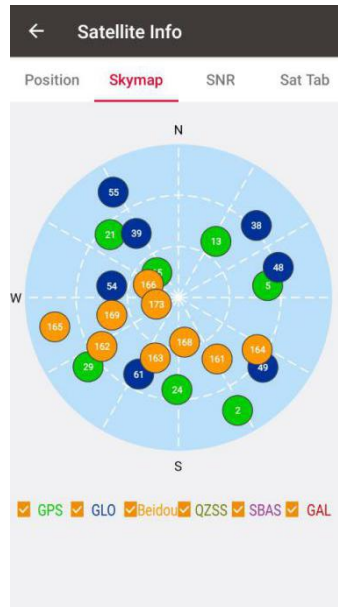

Figure 1.12 Satellite Info – Skymap

In the figure above, the sky map displays the elevation angle and azimuth of satellites of different satellite systems. A satellite at the center of the circle means its elevation angle is 90 degrees, a satellite on the circumference means its elevation angle is 0 degree. At the bottom of this interface, one or more constellations can be ticked to display.

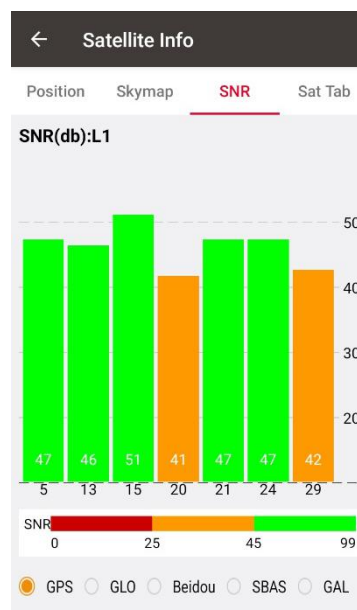

Figure 1.13 Satellite Info – SNR L1

In the figure above, it shows the SNR (Signal Noise Ratio) of different satellites in specified constellation. Clicking the histogram area can switch the SNR between L1, L2 and L5.

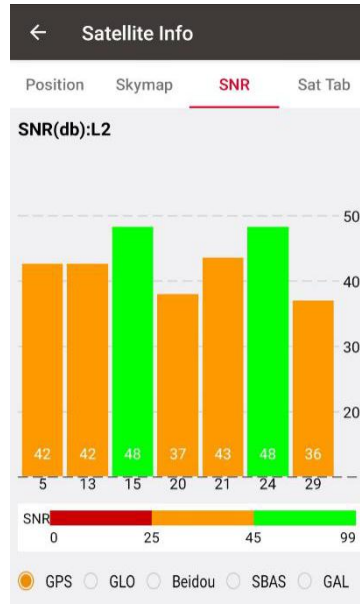

Figure 1.14 Satellite Info – LNR L2

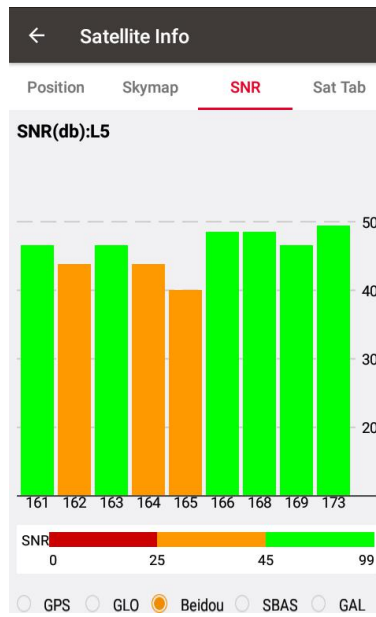

Figure 1.15 Satellite Info – LNR L5

| ← Satellite Info | | | | | | |
|------------------|--------|-----|-----|---------|----|------|
| Position | Skymap | SNR | | Sat Tab | | |
| Type | Pm | Azi | Ele | L1 | L2 | Lock |
| GPS | 2 | 152 | 14 | 32 | 28 | Used |
| GPS | 5 | 83 | 36 | 43 | 42 | Used |
| GPS | 13 | 34 | 49 | 45 | 37 | Used |
| GPS | 15 | 321 | 70 | 47 | 46 | Used |
| GPS | 21 | 312 | 36 | 43 | 36 | Used |
| GPS | 24 | 180 | 36 | 40 | 43 | Used |
| GPS | 29 | 231 | 22 | 43 | 37 | Used |
| GLONASS | 38 | 48 | 27 | 34 | 36 | Used |
| GLONASS | 39 | 328 | 45 | 42 | 42 | Used |
| GLONASS | 48 | 71 | 29 | 38 | 41 | Used |
| GLONASS | 49 | 128 | 26 | 38 | 40 | Used |
| GLONASS | 54 | 278 | 50 | 42 | 41 | Used |
| GLONASS | 55 | 327 | 17 | 36 | 39 | Used |
| GLONASS | 61 | 206 | 38 | 35 | 29 | Used |
| BeiDou | 161 | 147 | 47 | 36 | 44 | Used |
| BeiDou | 162 | 237 | 36 | 33 | 43 | Used |
| BeiDou | 163 | 200 | 51 | 35 | 43 | Used |
| BeiDou | 164 | 123 | 34 | 37 | 42 | Used |
| BeiDou | 165 | 256 | 15 | 32 | 37 | Used |
| BeiDou | 166 | 294 | 70 | 39 | 45 | Used |
| BeiDou | 168 | 173 | 63 | 41 | 45 | Used |
| BeiDou | 169 | 255 | 49 | 39 | 43 | Used |
| BeiDou | 173 | 251 | 76 | 43 | 44 | Used |

Figure 1.16 Satellite Info – Sat Tab

In the figure above, it shows the satellite information in table which including satellite type, PRN code, azimuth, elevation angle, SNR value of L1, SNR value of L2, and satellite using status.

2. Project

- Project
- CRS (CooRdinate System)
- Parameters
- Point
- Line
- Import
- Export
- Settings

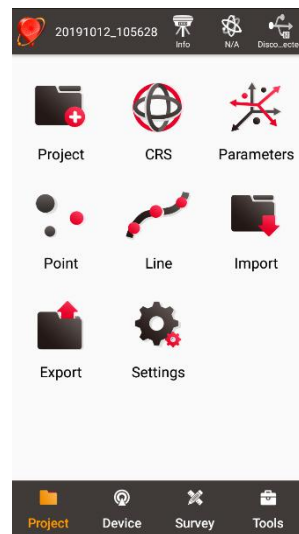

Figure 2.1 Functions under Project

2.1 Project

This section introduces how to create a new project, open / delete / edit an existing project.

2.1.1 New

A new project is necessary to manage all the data. On the Nuwa main interface as shown in Figure 1.10, click [Project] - > [New] to go to the following interface.

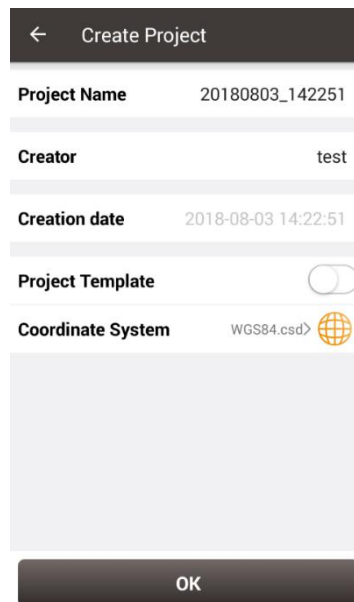

| Create Project | |
|-------------------|--|
| Project Name | 20180803_142251 |
| Creator | test |
| Creation date | 2018-08-03 14:22:51 |
| Project Template | <input type="checkbox"/> |
| Coordinate System | WGS84.csd  |
| OK | |

Figure 2.2 Create Project interface

[Project Name]: input the project name

[Creator]: input the name of the operator

[Creation date]: the date and time generates automatically.

[Project Template]: use an existing project settings

[Coordinate System]/ [Source Project]: select a coordinate system if project template is not turned on; select a source project if using a project template.

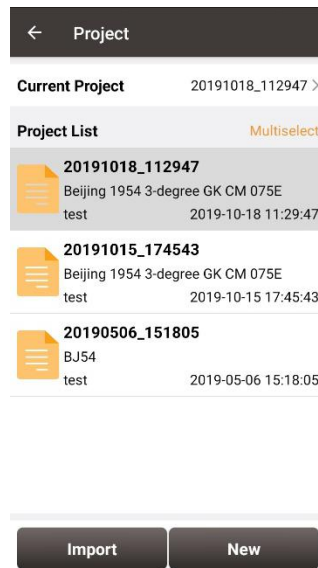

Figure 2.3 New project created

After a project is created, it will prompt out a window asking whether close the current project and open the new created project. The projects in the list are sorted in reverse chronological order. Refer to section 2.1.5 for more details about project property.

2.1.2 Import

In the Figure 2.3, an existing project can be imported from the storage of the android device by clicking [Import] on the bottom left of the interface.

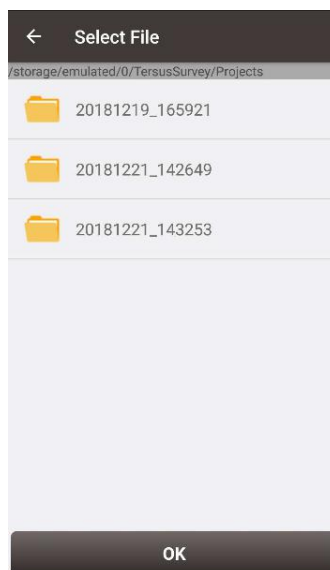

Figure 2.4 Project folders in an Android device

When importing projects from other sources, click [Import], select the Project folder under

TersusSurvey which is shown in Figure 2.4, and click [OK] and Nuwa imports all the projects in this folder.

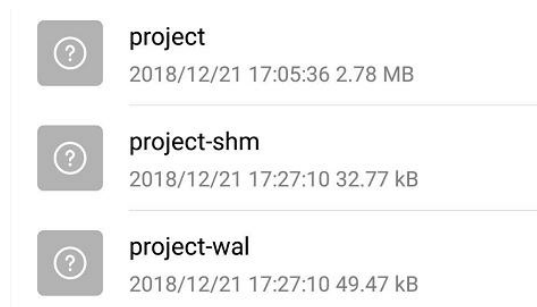

Figure 2.5 Sketch file containing the project info

Note: The imported project file should have a sketch file containing the project information (Project / Project-shm / Project-wal).

2.1.3 Open

If there is need to operate in an existing project, find it in the project list and click it. Nuwa prompts to open the project, click [OK].

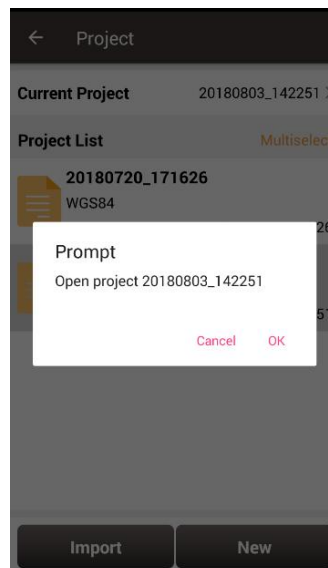

Figure 2.6 Open an existing project

2.1.4 Delete

Click [Multiselect] at the right side of Project List, select (single select, inverse select or select all) projects to be deleted. After the projects are selected, click [Delete] button to delete them. Nuwa prompts to confirm, click [OK] to complete the deletion.

Note: The current Project cannot be deleted in Nuwa app.

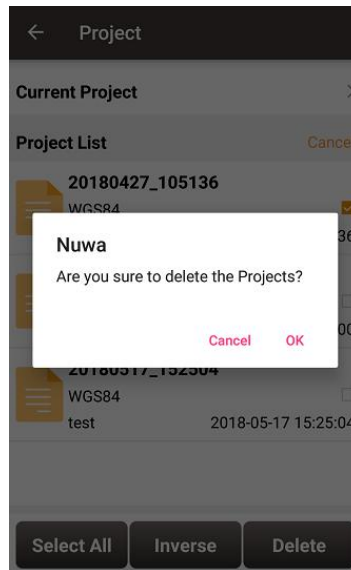

Figure 2.7 Delete Project

2.1.5 Edit Project Property

If a project is opened, the coordinate system can be edited, including ellipsoid, projection method and coordination transformation.

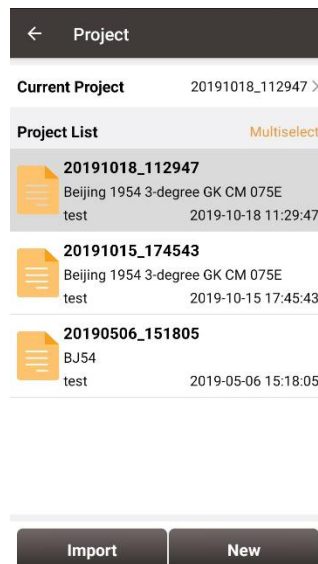

Figure 2.8 Project List

Click the [Current Project] to enter Project Property interface.

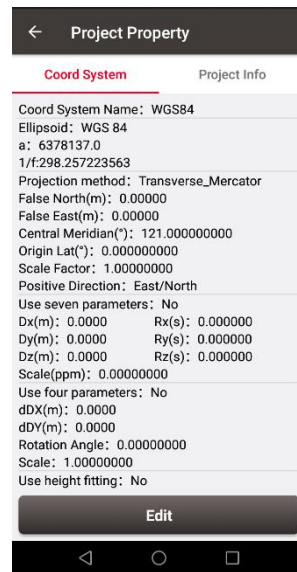

Figure 2.9 Project Property

Click [Edit] to input the ellipsoid parameters, projection type and coordination transformation, refer to section 2.2.2 for details.



Figure 2.10 Share Project Info

Click [Share] to share the project parameters with others. The detailed usage refers to section 2.2.1.

2.2 CRS (CooRdinate System)

Nuwa app supports user-defined coordinate system. A user-defined coordinate system can be saved as a template. A CRS can be created, imported, edited and deleted in the CRS management interface.

On the Nuwa main interface as shown in Figure 1.10, click [CRS] to get the coordinate system list which is shown below.



Figure 2.11 Coordinate System List

2.2.1 New CRS

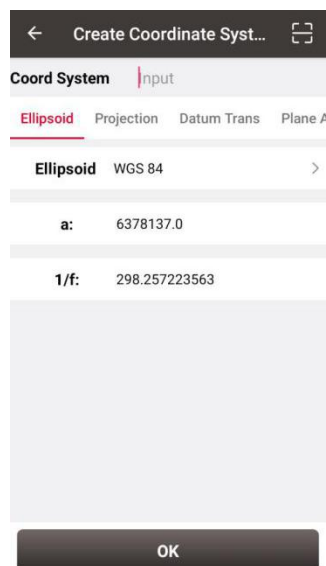

Figure 2.12 Create a new CRS

Click [New] to create a new CRS, input the coordinate system name, select the right ellipsoid, projection, datum transformation, plane adjustment, and height fitting, refer to the following screenshots:

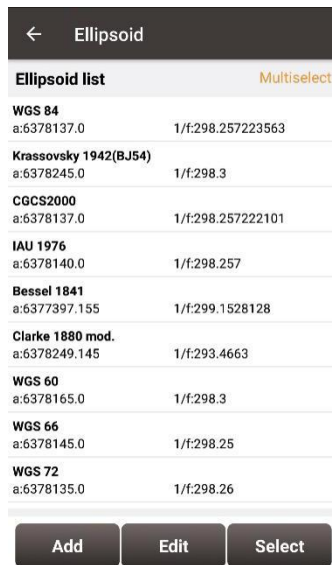

Figure 2.13 Ellipsoid list

[Ellipsoid]: Select the correct ellipsoid parameters, including ellipsoid name, semi-major axis, inverse flattening, etc. For a predefined ellipsoid, it automatically fills the semi-major axis and inverse flattening after selecting the ellipsoid; if the ellipsoid that meets the requirements is not found in the predefined ellipsoid, and you have the parameters of the ellipsoid, you can [Add] an ellipsoid to the list, enter your parameters and select it; If the ellipsoid that meets the requirements is not found in the predefined ellipsoid and you do not have the parameters for this ellipsoid, please contact Tersus technical support.

Note: The default ellipsoid is WGS84.

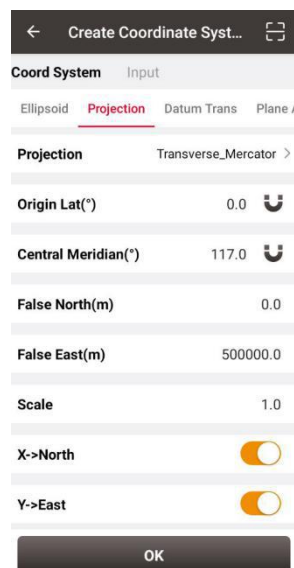

Figure 2.14 Projection interface

[Projection]: Including Transverse Mercator, UTM, Lambert conformal conic 1SP, Lambert

conformal conic 2SP, and etc which is listed as below. If the required projection is not found in the predefined projection list, please contact Tersus technical support.

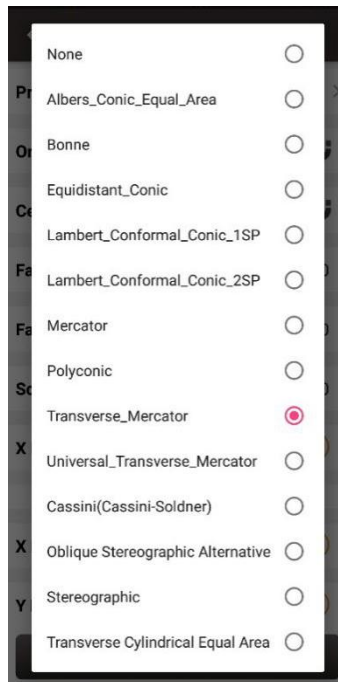

Figure 2.15 Projection list

Origin latitude, central meridian and other parameters can also be configured in Projection interface which is shown above. Fill in these information according to the actual needs. Turn on [X -> North] to indicate that the positive part of X axis is north, negative part is south. Turn on [Y -> East] to indicate that the positive part of Y axis is east, negative part is west.

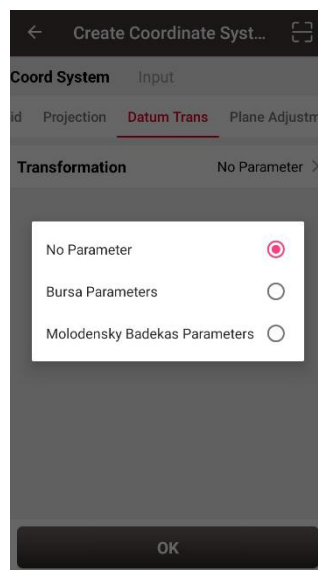

Figure 2.16 Datum transformation options

[Datum Transformation]: Datum transformation is necessary when the source ellipsoid is different from the target ellipsoid. There are three options: No parameter, Bursa Parameters and Molodensky Badekas Parameters.

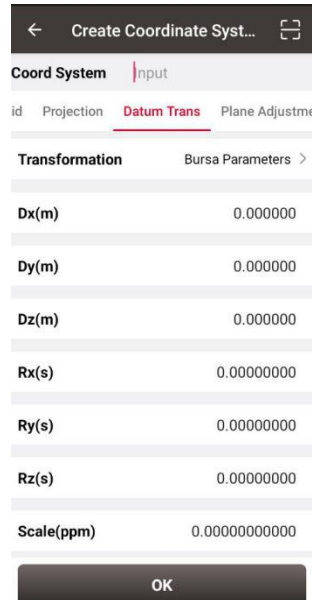

Figure 2.17 Bursa Parameters

[Bursa Parameter]: Axis shift, rotation and scale would be introduced in the datum transformation. Bursa-Wolf seven-parameter model is used from local coordinate to WGS84 system. At least three known points are necessary for accurate transformation. Only X/Y/Z shifts are required only if three parameter transformation is needed.

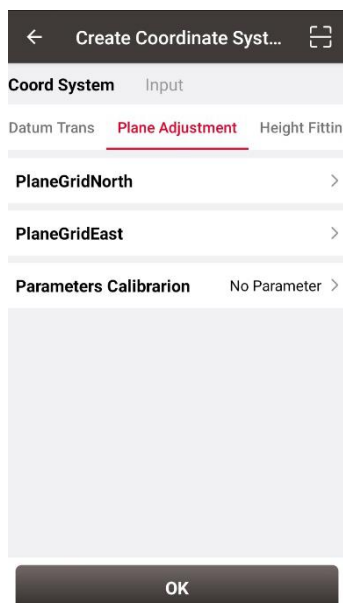

Figure 2.18 Plane adjustment interface

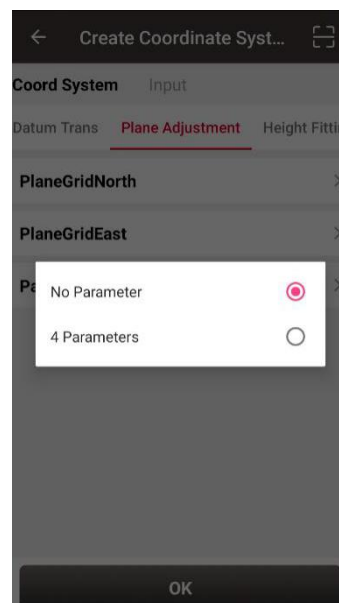

Figure 2.19 Plane adjustment options

[Plane Adjustment]: Plane adjustment is for the transformation between two planes. There are two options for parameters calibration: No parameter and 4 parameters. The detailed information and usage of plane grid refer to section 2.2.5.

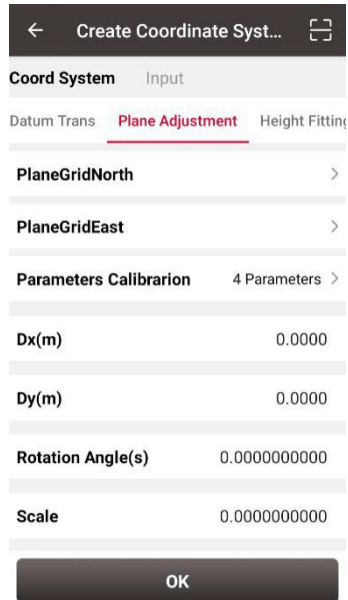

Figure 2.20 4 Parameters

[4 Parameters]: X/Y axis shift, rotation angle and scale are necessary to be input as above.

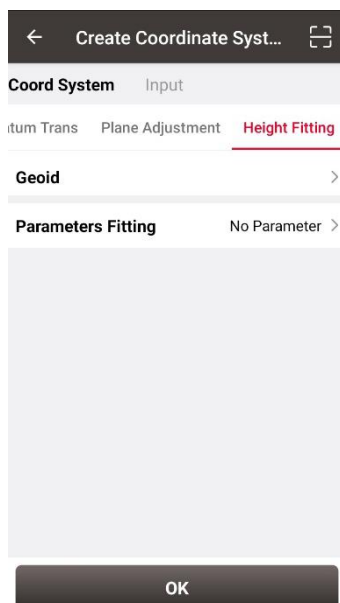

Figure 2.21 Height fitting interface

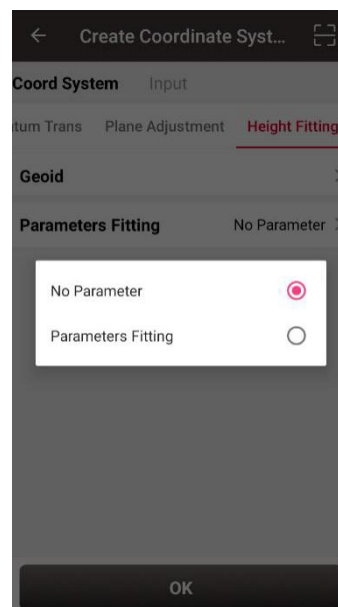

Figure 2.22 Parameters fitting options

[Height Fitting]: Height fitting has two options: Geoid and Parameters Fitting. Parameters

fitting includes no parameter and detailed parameters fitting.

[Geoid]: Geoid supports .ggf, .grd, .gsf, and .osgb format files, the detailed information and usage of geoid files refer to section 2.2.5.

[Parameters Fitting]: currently three algorithms are supported: fixed difference correction, plane fitting and surface fitting.

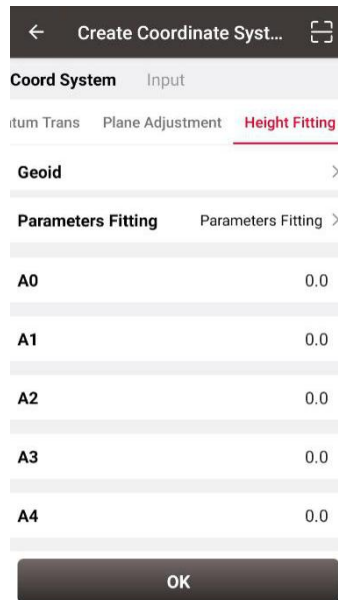



Figure 2.23 Height Fitting – Parameters Fitting

After setting all parameters to create a new coordinate system, click [OK] to complete the configuration.

Click the scan icon  in the top right corner of Figure 2.12, open the camera to scan other surveyor's coordinate system parameters QR code to copy information for creating a new CRS.

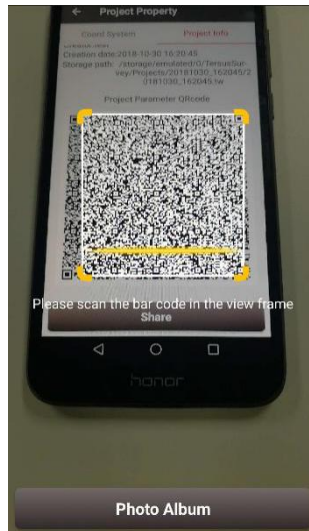

Figure 2.24 Scan QR code to get CRS info

The following shows detailed steps:

- 1) The copied surveyor opens in turn: [Project] -> [Current Project] -> [Project Information], then displays the complete QR code;
- 2) The current surveyor opens the camera when creating new CRS to scan the QR code displayed as shown in Figure 2.24 above and can copy its coordinate system parameters. The QR code screenshot in photo album can also be scanned to obtain the CRS parameters.

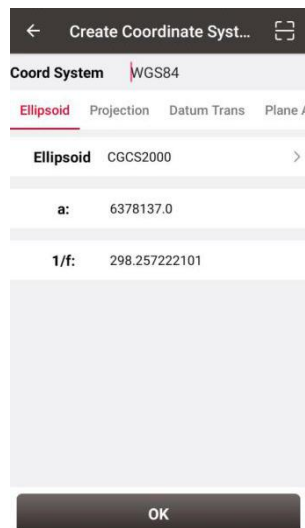

Figure 2.25 CRS info obtained by scanning QR code

- 3) The coordinate system parameters are obtained as shown in the figure above.

2.2.2 Import CRS

Click [Import] on the bottom left of CRS interface which is shown in Figure 2.11, it shows predefined coordinate systems for users to choose.

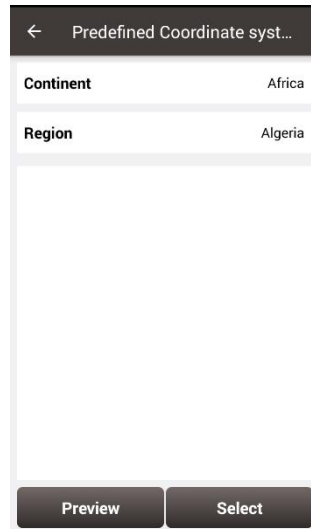

Figure 2.26 Predefined CRS

In the figure above, the predefined coordinate systems are classified by continent and region.

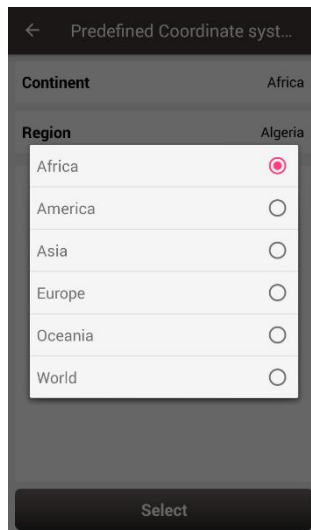

Figure 2.27 Continent options

The continent option includes Africa, America, Asia, Europe, Oceania and World as shown in the figure above. Select a continent, a country or a region, then select a CRS and click [Preview].

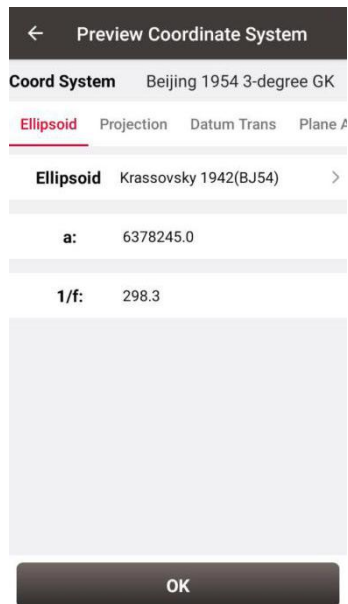

Figure 2.28 Preview of predefined CRS

Figure 2.28 is a preview of 'Beijing 1954 3-degree GK CM 075E' coordinate system. Click [OK] and [Select] this CRS, the CRS file is imported to Coordinate System List as shown in Figure 2.29.

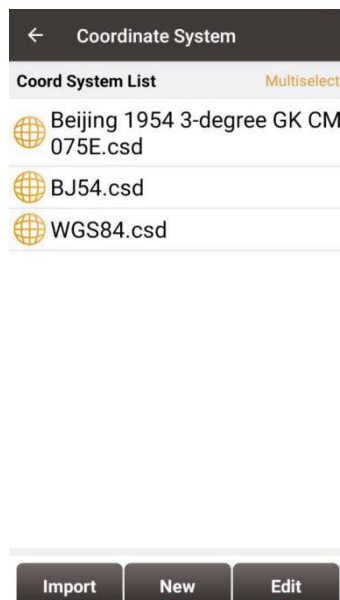

Figure 2.29 Example of CRS import

If the user cannot find the coordinate system of their country or region, but has ellipsoid, projection, datum transformation and other related parameters, you can create a new coordinate system or contact Tersus technical support and we help you create one.

2.2.3 Edit CRS

Click an existing CRS and click [Edit] to enter the Edit Coordinate System interface, refer to the following screenshot:

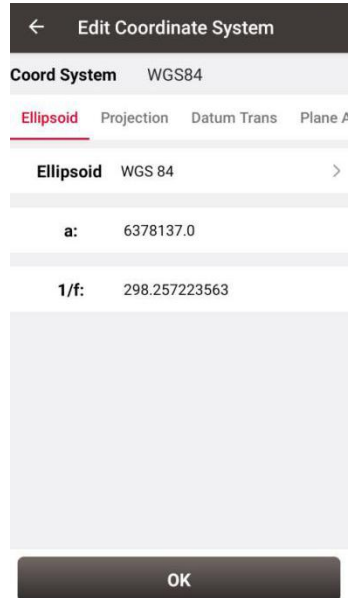

Figure 2.30 Edit Coordinate System

2.2.4 Delete CRS

The default two CRS cannot be deleted. Click [Multiselect] to select the CRS to be deleted and click [Delete] to finish the deletion.

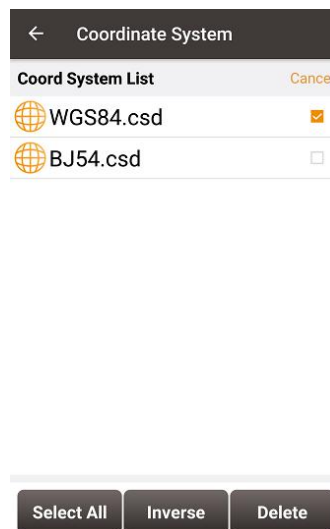

Figure 2.31 Delete CRS

2.2.5 Plane Grid and Geoid

Plane Grid and Geoid are adjustment methods for plane and height, which can improve survey accuracy.

Plane Grid includes plane grid north and plane grid east. Click [PlaneGridNorth] in Figure 2.18 Plane adjustment interface, it enters plane grid north list shown as below. Click [More] to enter download list, the plane grid files can be downloaded from online server. Click [Refresh] to view the current available plane grid files. The plane grid file supports .ggf, .grd, .gsf, and .osgb format. If customer cannot find suitable plane grid file, feel free to contact Tersus support via email support@tersus-gnss.com.



Figure 2.32 Plane Grid list

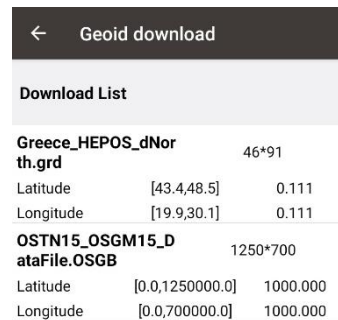

Figure 2.33 Plane Grid download list

After downloading a required plane grid file, select it in the plane grid list and it returns to the plane adjustment interface.

Setting the PlaneGridEast is the same with the above method of setting PlaneGridNorth.

Geoid supports .ggf, .grd, .gsf, and .osgb format files, it optimizes data loading, reduces waiting time for different devices, simplifies algorithm calculation process and saves system resources. In a CRS setting, click [Geoid] under Height Fitting tab enter Geoid list which is shown as below. The list shows the coverage latitude, longitude and resolution of

the corresponding geoid model. Click [More] to enter download list, the geoid files can be downloaded from online server.



Figure 2.34 Geoid list



Figure 2.35 Geoid download list

Click [Refresh] to view the current available geoid files. Contact Tersus Technical Support support@tersus-gnss.com to inquire more if customer cannot find suitable Geoid files. After downloading a required geoid file, select it in the geoid list and it returns to the height fitting interface.

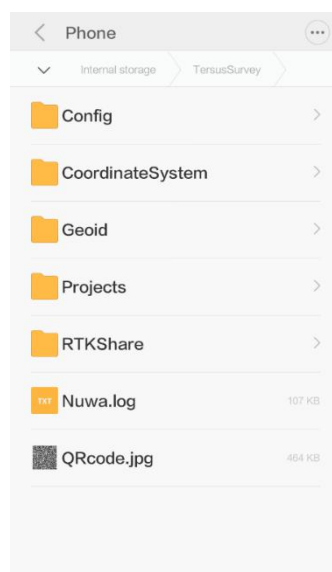

Figure 2.36 Explore Geoid folder in the android device

Another method of importing geoid files: manually copy and paste the Geoid files under the Geoid folder of TersusSurvey as shown above, back to the Geoid list interface and click [Refresh] to view the available Geoid list as shown below.



Figure 2.37 Refresh to view the Geoid list

Select one suitable Geoid model and click [Select] to complete the Geoid configuration, and it returns to the height fitting interface.

2.3 Parameters

Seven Parameter and Three Parameter methods are introduced in this section.

Seven Parameter: this method can cover long distance range, generally more than 50 km. At least three known points are required in local datum and in WGS84 system before calculating.

Three Parameter: at least one known point is required. This method can cover short distance range; the accuracy is determined by working area and decreased with the distance.

The following is an example of Seven Parameter. Click [Project] -> [Parameters] to enter the following interface.

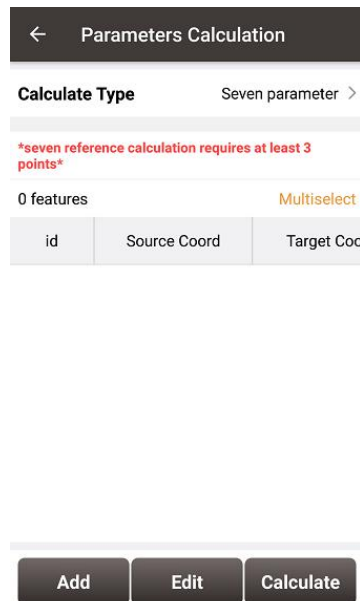

Figure 2.38 Parameters Calculation

Select seven parameter for Calculate Type, click [Add] on the bottom left to input the known points.

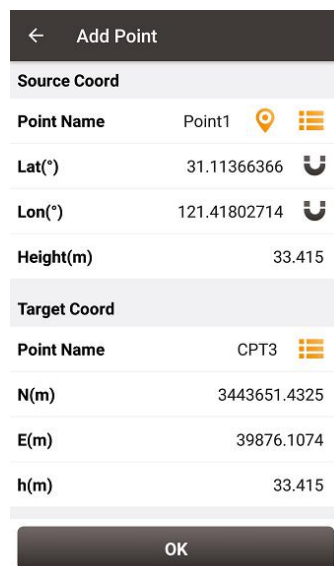

Figure 2.39 Add Point for calculation

For the Source Coordinate, input Latitude, Longitude and Height by manual input, collected from a Tersus receiver or selected from the survey point list. For the Target Coordinate, input the local values from manual input or selected from the control point list.

- Manual input

Input the point position according to the format required. The latitude/longitude format can be changed by clicking the U icon on the right.

- Point library

Click [📄] to load points from point library. Points can be added by clicking [Add] in the Point interface.

- Smooth Acquisition

Click [📍] to start smooth acquisition through Tersus receiver.

After points are added, click [Calculate] on the bottom right to do the parameter transformation. The result is shown as below screenshot:

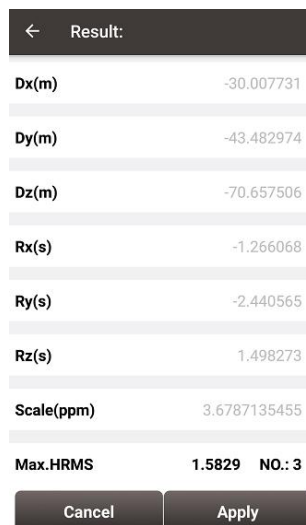

| ← Result: | |
|------------|---------------|
| Dx(m) | -30.007731 |
| Dy(m) | -43.482974 |
| Dz(m) | -70.657506 |
| Rx(s) | -1.266068 |
| Ry(s) | -2.440565 |
| Rz(s) | 1.498273 |
| Scale(ppm) | 3.6787135455 |
| Max.HRMS | 1.5829 NO.: 3 |

Figure 2.40 Parameters Calculation Result interface

Note: Before this calculation, please make sure that the project parameters (ellipsoid, projection, etc.) are used correctly.

After the calculation is completed, click [Apply] to apply to the datum transformation parameters of the current project coordinate. When Max.HRMS is too large, the software will prompt a notice of whether continue to apply if the value is too large; if you click [Cancel], it will not be applied to the datum transformation parameters.

2.4 Point

Point library includes survey point library, control point library and stakeout point library.

Points can be added into a library. Editing, searching and checking detail information can be done under this Point interface.

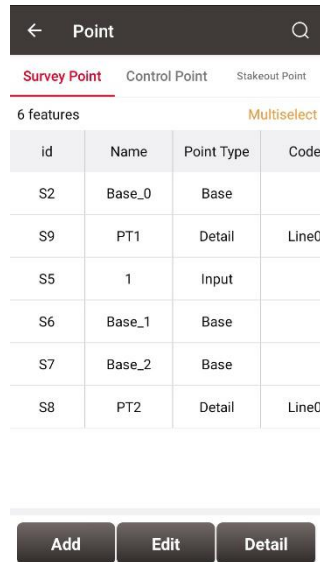

| id | Name | Point Type | Code |
|----|--------|------------|-------|
| S2 | Base_0 | Base | |
| S9 | PT1 | Detail | Line0 |
| S5 | 1 | Input | |
| S6 | Base_1 | Base | |
| S7 | Base_2 | Base | |
| S8 | PT2 | Detail | Line0 |

Figure 2.41 Point Interface

A point can be imported into the control point library or the stakeout point library. In the point library interface, slide in the left or right direction to check the point information, such as coordinates, collection time, and etc.

2.4.1 Add Point

Under the Point interface, click [Add] to enter the Add Point interface. The following figures take the control point as an example.

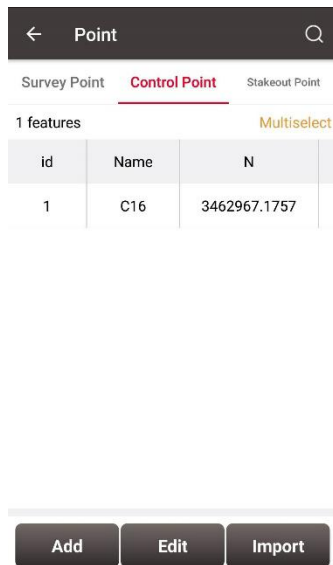

Figure 2.42 Control Point interface

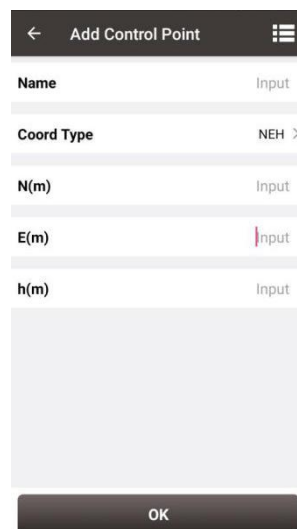

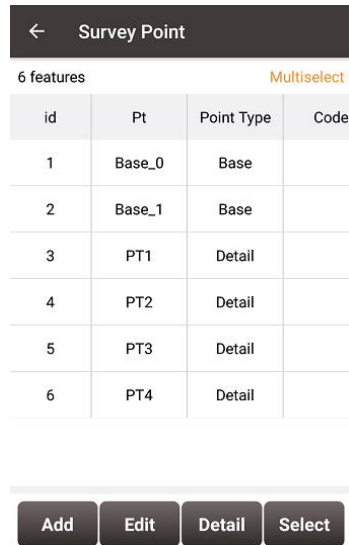

Figure 2.43 Add Control Point

Choose the coordinate type (including two types: BLH and NEh), input the point name and the coordinate values, or click the upper right  icon to import the survey point directly.



| ← Survey Point | | | |
|----------------|--------|------------|-------------|
| 6 features | | | Multiselect |
| id | Pt | Point Type | Code |
| 1 | Base_0 | Base | |
| 2 | Base_1 | Base | |
| 3 | PT1 | Detail | |
| 4 | PT2 | Detail | |
| 5 | PT3 | Detail | |
| 6 | PT4 | Detail | |

Add Edit Detail Select

Figure 2.44 Import Survey Point

Under the Stakeout Point interface, adding stakeout point is similar with that of adding control point.

2.4.2 Search Point

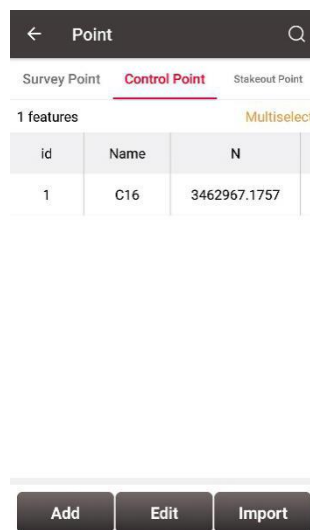

| ← Point | | |
|--------------|----------------------|----------------|
| Q | | |
| Survey Point | Control Point | Stakeout Point |
| 1 features | | Multiselect |
| id | Name | N |
| 1 | C16 | 3462967.1757 |

Add Edit Import

Figure 2.45 Control Point interface

Click the up-right  icon to enter Point Query interface which is shown in the figure above. Target Points can be survey points, control points or stakeout points.

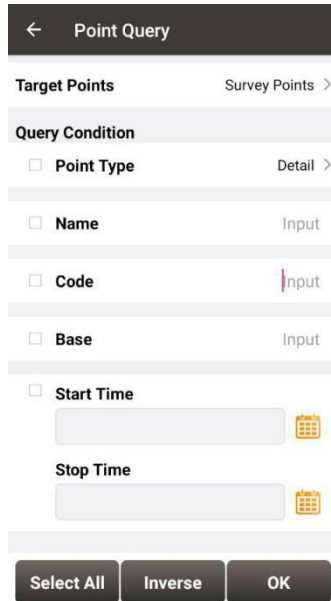

Figure 2.46 Point Query interface

Query condition details are as follows:

[Point Type]: Detail, continuous, input point, calculate or base.

[Name]: Point name to be queried.

[Code]: Code number.

[Base]: The name of the base.

[Start/Stop Time]: Start and stop time of the points

Click [OK] to search all the points meeting the query conditions.

2.4.3 Edit Point

Choose the points to be edited, and click [Edit] to enter the Edit interface.

Note: *There is an exception that in the Survey Point tab, only the code info can be edited apart from the manual input points.*

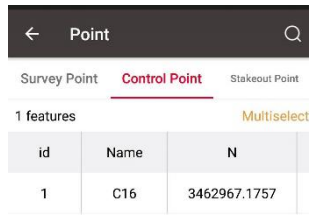

Figure 2.47 Control Point interface

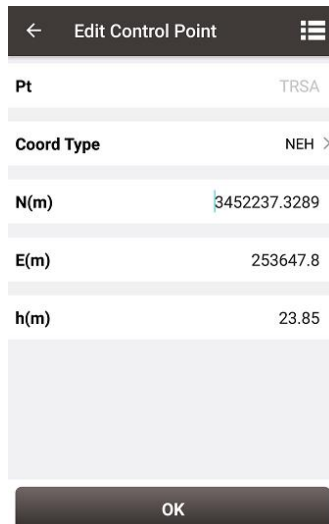

Figure 2.48 Edit Control Point interface

Editing Stakeout Point is similar with the steps of editing control point.

2.4.4 Import Point

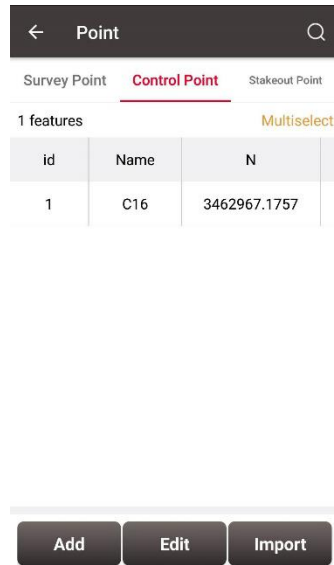

Figure 2.49 Control Point interface

Under the Control Point interface, click [Import] at the bottom right corner and then [Data Format].

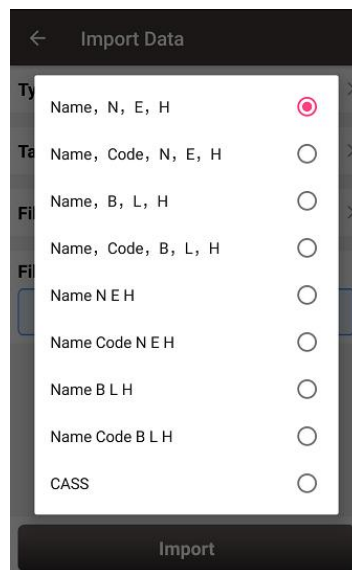

Figure 2.50 Data format list

Select a format in the pop-up list which is shown in the figure above.

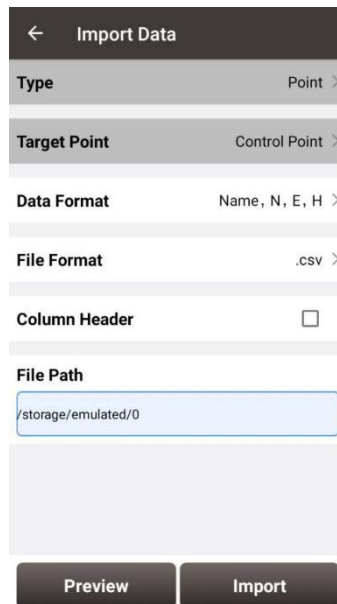

Figure 2.51 Import Data info

Select file format and file path to import points. Then click [Import] to import the required points.

Under the Stakeout Point interface, click [Import] at the bottom right corner, select a source in the pop-up list. Choosing [From File] leads to the similar steps of importing Control Point. Choosing [From Survey Point] leads to the Figure 2.53 below. One or more points can be selected and imported as Stakeout Points.

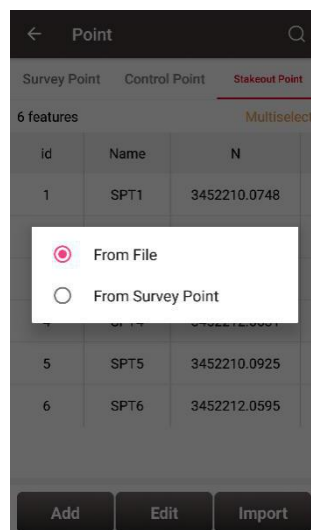
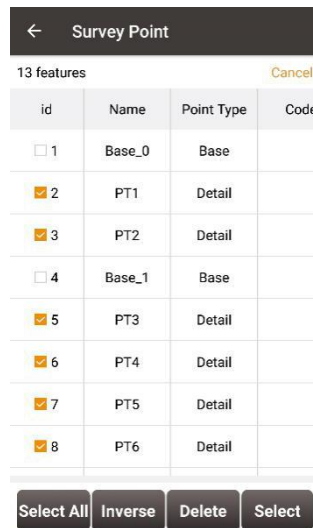

Figure 2.52 Import source for Stakeout Point



| id | Name | Point Type | Code |
|---------------------------------------|--------|------------|------|
| <input type="checkbox"/> 1 | Base_0 | Base | |
| <input checked="" type="checkbox"/> 2 | PT1 | Detail | |
| <input checked="" type="checkbox"/> 3 | PT2 | Detail | |
| <input type="checkbox"/> 4 | Base_1 | Base | |
| <input checked="" type="checkbox"/> 5 | PT3 | Detail | |
| <input checked="" type="checkbox"/> 6 | PT4 | Detail | |
| <input checked="" type="checkbox"/> 7 | PT5 | Detail | |
| <input checked="" type="checkbox"/> 8 | PT6 | Detail | |

Figure 2.53 Import from Survey Point

2.4.5 Delete Point

Click [Multiselect] in the point interface to enter the following interface. Select the points to be deleted and click [Delete] to complete the deletion.

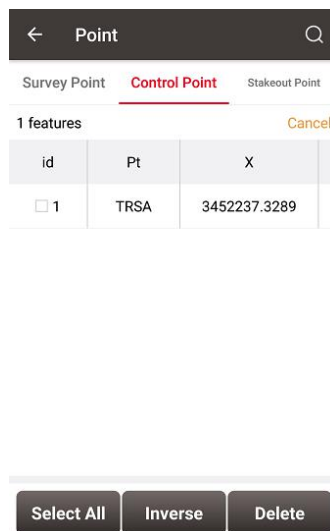

| id | Pt | X |
|----------------------------|------|--------------|
| <input type="checkbox"/> 1 | TRSA | 3452237.3289 |

Figure 2.54 Delete Point interface

Note: The base point in the survey point library cannot be deleted.

2.5 Line

New lines can be added, existing lines can be searched, edited and deleted.

2.5.1 Add Line

Click [Project] -> [Line] to enter the line interface. It shows Survey Line and Stakeout Line.



Figure 2.55 Line interface

Click [Add] under Survey Line to enter the following interface.

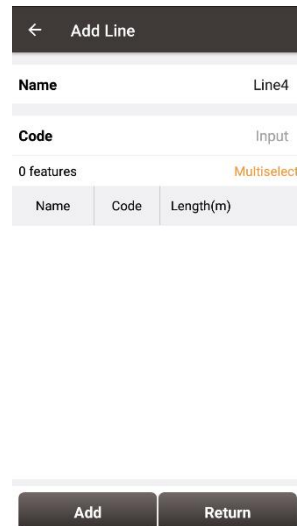

Figure 2.56 Add survey line interface

Input a line name or use the default name, input a code for comment purpose, click [Add] in the bottom left to select two points in the survey point library as below.

← Survey Point

74 features Multiselect

| id | Name | Point Type | Code |
|----|--------|------------|-------|
| S1 | Base_0 | Base | |
| S2 | PT1 | Continuous | Line0 |
| S3 | PT2 | Continuous | Line0 |
| S4 | PT3 | Continuous | Line0 |
| S5 | PT4 | Continuous | Line0 |
| S6 | PT5 | Continuous | Line1 |
| S7 | PT6 | Continuous | Line1 |
| S8 | PT7 | Continuous | Line1 |
| S9 | PT8 | Continuous | Line1 |

Add Edit Detail Select

Figure 2.57 Select two points from survey point library – 1

← Add Line

Name Line4

Code test

2 features Multiselect

| Name | Code | Length(m) |
|------|------|-----------|
| PT71 | | - |
| PT72 | | 0.0014 |

Add Return

Figure 2.58 Select two points from survey point library – 2

Click [Return] and the new survey line has been added as below.

← Line 🔍

Survey Line Stakeout Line

3 features Multiselect

| Name | Code | Start Point | End Point |
|-------|------|-------------|-----------|
| Line0 | test | PT1 | PT2 |
| Line1 | test | PT2 | PT3 |
| Line2 | test | PT3 | PT6 |

Add Detail

Figure 2.59 Survey line added

The added survey line can be viewed under [Survey]-> [Point Survey] shown as below.

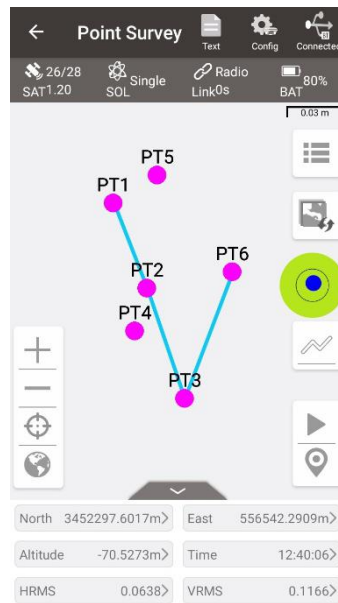

Figure 2.60 Survey line in survey interface

Click [Add] under Stakeout Line to enter the following interface, there are two methods.

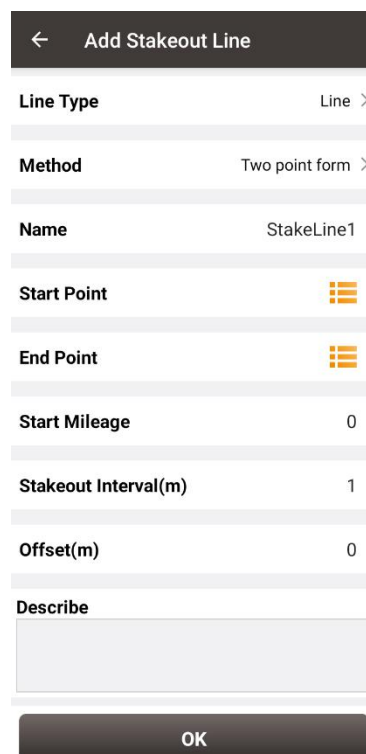

Figure 2.61 Add stakeout line method 1

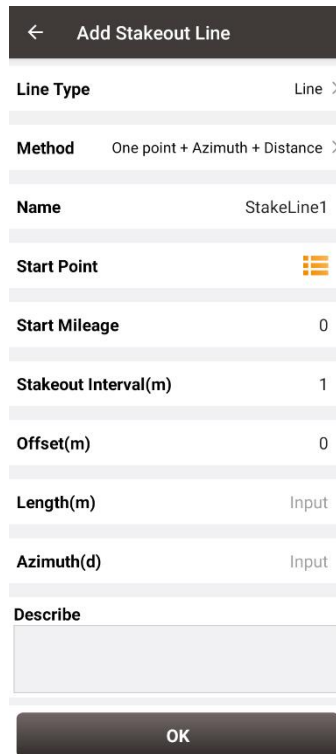



Figure 2.62 Add stakeout line method 2

Two methods of adding a stakeout line: Two Points and One point + Azimuth +Distance.

- Two Points:

Input the name of the line, then click  to import the start point and end point.

- One point + Azimuth + Distance

Input the name of the line, then click  to import the start point from a point library.

Input the other information for the line.

2.5.2 Search Line

Click the  icon at the up-right corner, the line query interface is shown as below. Input the search items and tick the item, click [OK] to search the line.

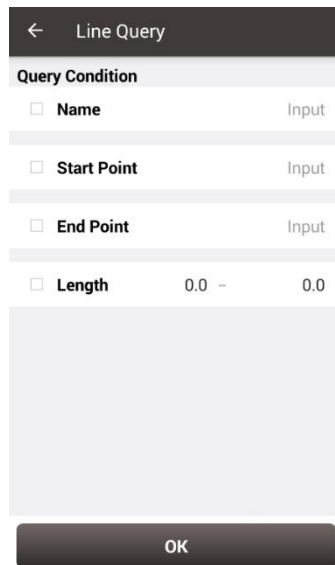
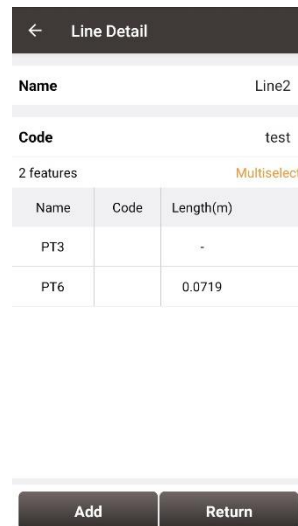

Figure 2.63 Line Query interface

2.5.3 Edit Line

In the Line interface, select the line to be edited. Then click [Detail] to enter the edit page, editing survey line is shown as below.



| Name | Code | Length(m) |
|------|------|-----------|
| PT3 | | - |
| PT6 | | 0.0719 |

Figure 2.64 Edit a survey line 2

If not selecting a point, click [Add] to add a point at the end shown as Figure 2.65; if selecting a point, then click [Add] to insert a point before the selected point shown as Figure 2.67. After adding the point, the length will be recalculated, and then enter the survey interface to find that the added point is connected to the line shown as Figure 2.66 and Figure 2.68.

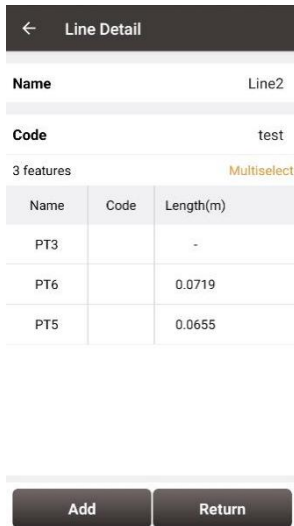

Figure 2.65 Add PT5 to the line end

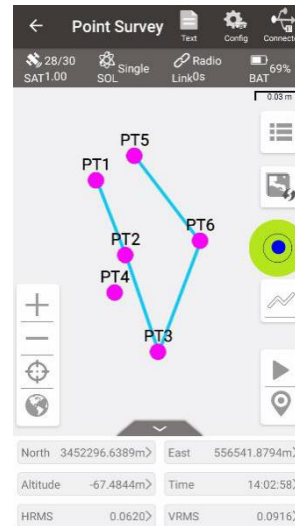

Figure 2.66 The new Line2 in survey interface

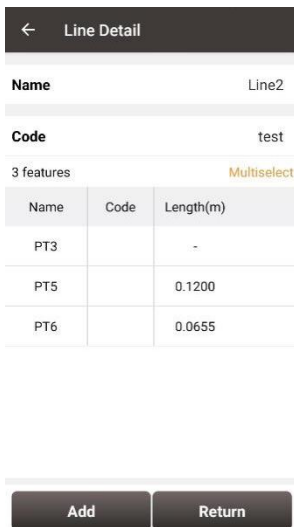

Figure 2.67 Add PT5 before PT6

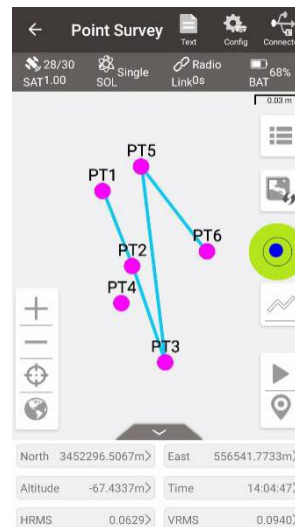

Figure 2.68 The new Line2 in survey interface

Click [Multiselect] to select a point and click [Delete]. After the deletion, the length will be recalculated, and then enter the survey interface to find that the deleted point is no longer connected to the line. For example, after deleting PT5 in Line2, this point PT5 is no longer in Line2 shown as below.

Note: After deleting the point in the line, the point and its information will be retained in the point library. It exists as a point, but it is no longer connected to the line.

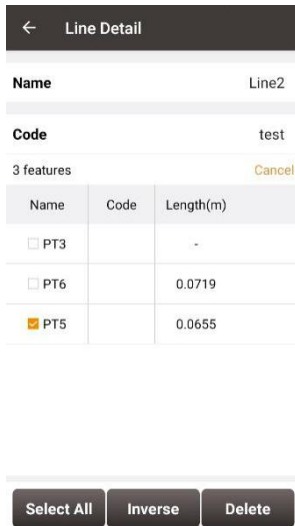

Figure 2.69 Delete PT5 in Line2

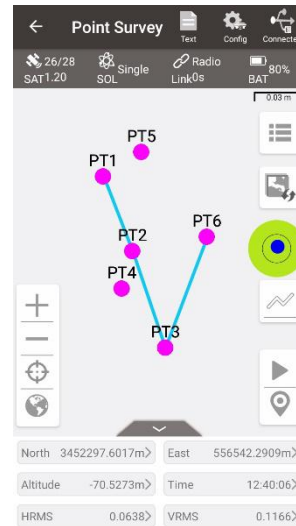

Figure 2.70 Line2 after deleting PT5

If editing a stakeout line, just select the stakeout line, click [Detail] to enter the edit page and edit the line parameters shown as below.

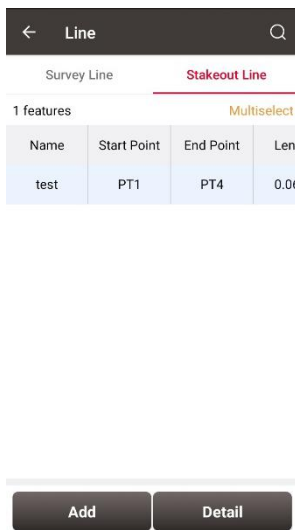

Figure 2.71 Select a stakeout line

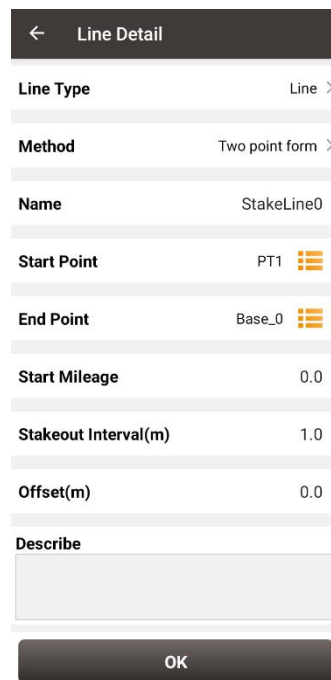

Figure 2.72 Edit a stakeout line

2.5.4 Delete Line

In the Line interface, click [Multiselect] to enter the following interface. Tick the line to be deleted, then click [Delete] to complete deletion.

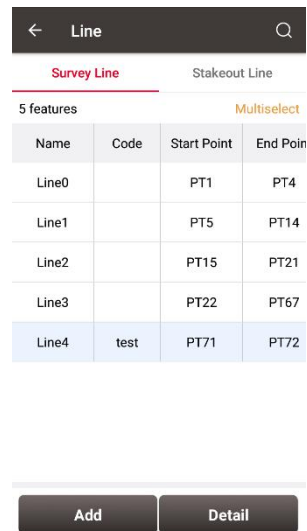

Figure 2.73 Line interface

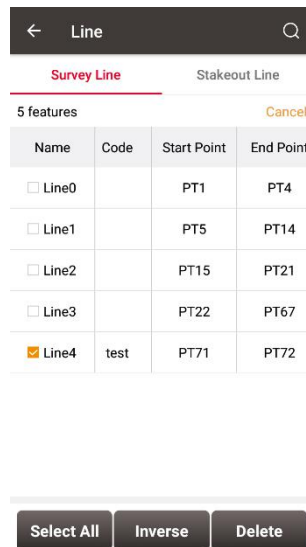

Figure 2.74 Tick the line to be deleted

2.6 Import

There are two types of import: Coordinate Import and Other Import. Coordinate import is to import files with .csv and .dat format. Other Import is to import files with .dxf, .shp and .sima format.

2.6.1 Coordinate Import

Under the Coordinate Import interface, select Type, Target Point library to be added, Data Format, File Format and the file path where the file is located, click [Import] to complete the import.

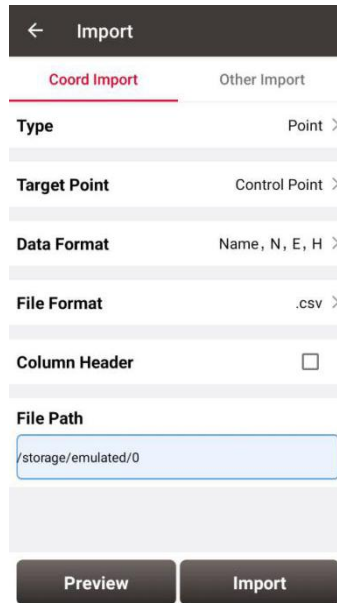

Figure 2.75 Import interface

The figure above shows the parameters that should be selected or filled for coordinate import.

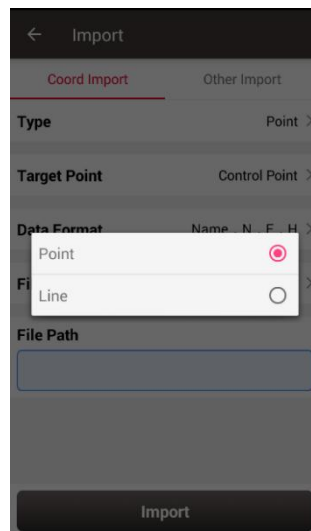

Figure 2.76 Import Type

For point import, select [Point] for Type as shown above.

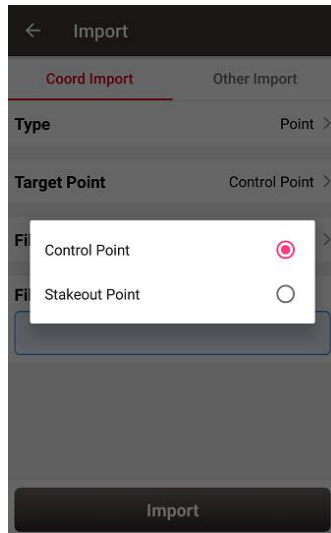

Figure 2.77 Target Point Library

The target point library has two options: control point and stakeout point as shown above.

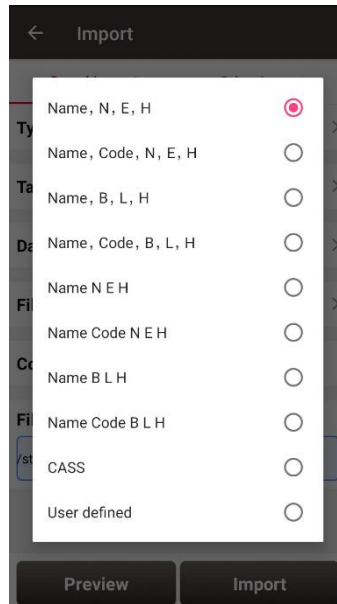

Figure 2.78 Data Format options

The data format options for data import are listed in the figure above.

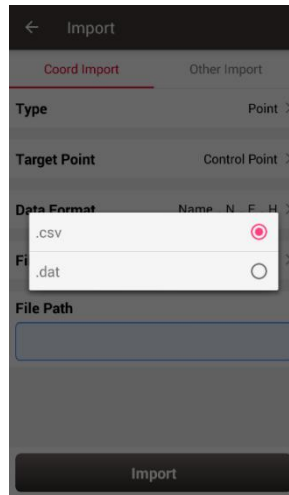

Figure 2.79 File Format options

There are two options for file format of imported points: .csv and .dat files.

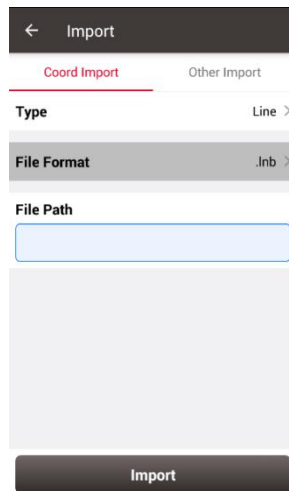

Figure 2.80 Import Line interface

For line import, select [Line] for Type in Figure 2.76 and it goes to the import line interface as shown in Figure 2.80 above. The file format for line is .lnb file.

The line file is a text file with the .lnb extension in nature. The detailed content in the text file is shown as below. The information from left to right is: starting point name, starting point N, starting point E, starting point h, 0, ending point name, ending point N, ending point E, ending point h, 0, 0.

```
5K+250-1,3453407.198,496492.9505,0,0,5K+250-2,3453312.565,496460.4625,0,0,0
5K+300-1,3453388.743,496542.6277,0,0,5K+300-2,3453300.967,496507.4977,0,0,0
5K+350-1,3453368.497,496589.9064,0,0,5K+350-2,3453277.249,496550.8326,0,0,0
```

Figure 2.81 Example content in the .lnb file

2.6.2 Other Import

Under the Other Import interface, select the file type and the file path, click [Import] to import the file. Currently this function is not support and is to be developed.

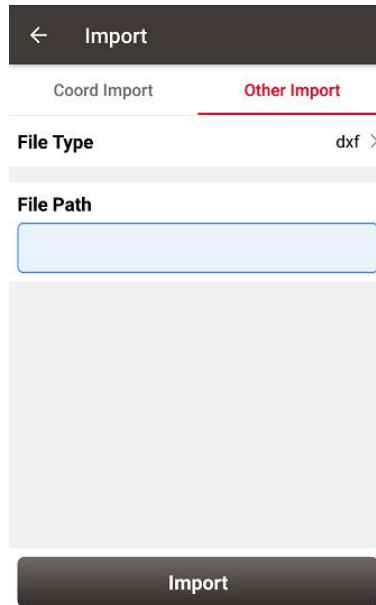

Figure 2.82 Other Import interface

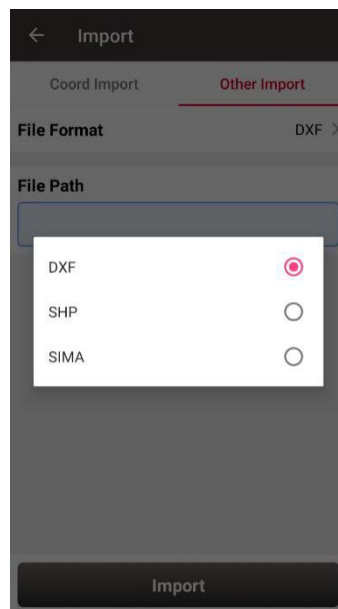

Figure 2.83 File Type for other import

2.7 Export

Correspondingly there are two types of export: Coordinate Export and Other Export. Coordinate Export is to export .csv files whose file name extension can be modified as .dat; Other Export is to export files with .kml, .shp, .dxf, .html, .xml and .sima format.

2.7.1 Coordinate Export

Under the Coordinate Export interface, select Point Type, Date range and Data Format, ensure the File Name and Storage Path is correct.

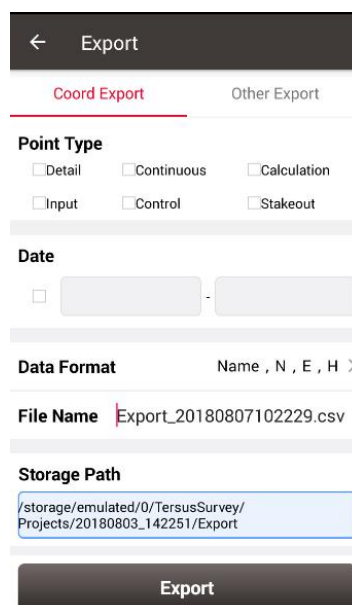

Figure 2.84 Export Interface

Thereafter click [Export] to complete the export.

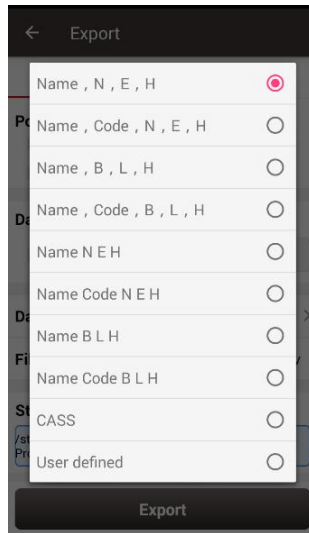

Figure 2.85 Data Format options

For Data Format, the user-defined format can be created or managed. Click [User defined] and it prompts out an option for data format: create data format and manage data format which are shown as below.

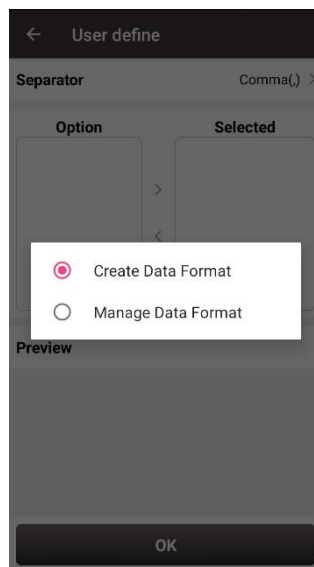

Figure 2.86 User defined data

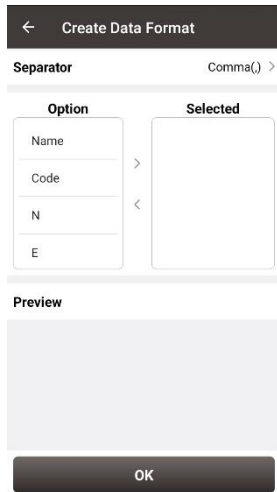

Figure 2.87 Create data format

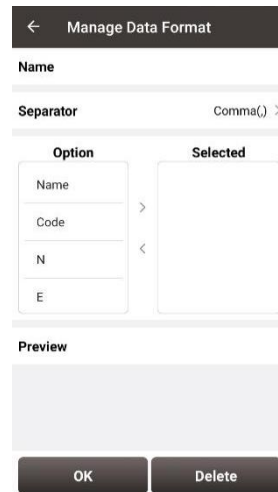

Figure 2.88 Manage data format

2.7.2 Other Export

Under the Other Export interface, file format can be KML, SHP, DXF, HTML, XML or SIMA. Type in the export file name and click [Export] to complete the file export. Please be noted that KML file is the BLH coordinate under the WGS84 coordinate system, SHP / DXF file is the NEH format coordinate under the local coordinate system, HTML file contains task information, coordinate reference system and survey points, XML file supports EZSurvey import.

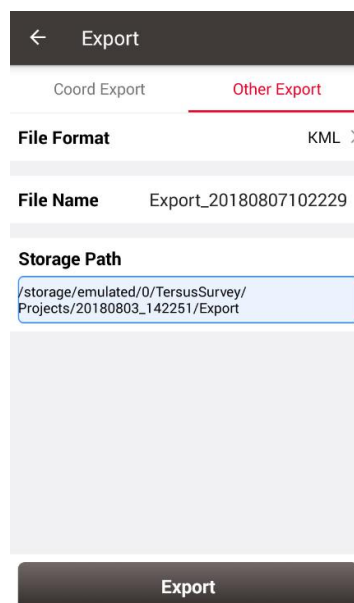

Figure 2.89 Other Export interface

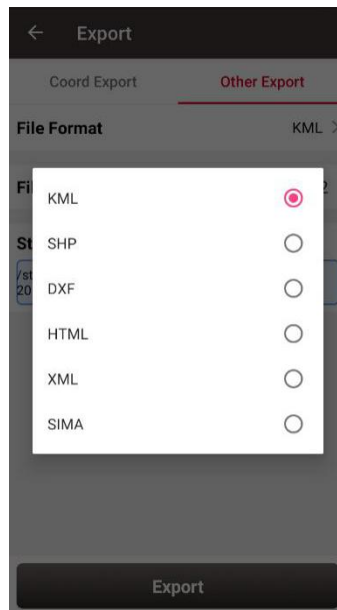

Figure 2.90 File Format for other export

If selecting XML for the file format, select start date and stop date of the Stop&Go survey to ensure the XML file recorded the correct stop points during the Stop&Go survey work.

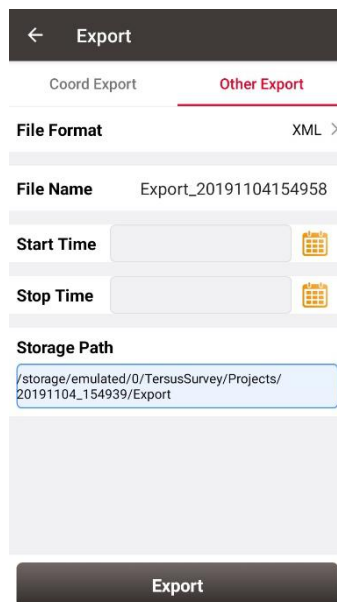

Figure 2.91 Export XML file

Copy the XML file to a computer and open this XML file using a text reader software. Change the rover observation file name on the fifth row to the rover Rinex file name which is shown as below.

```

<?xml version="1.0" encoding="UTF-8"?>
- <GNSSProject xmlns:xsd="http://www.w3.org/2001/XMLSchema"
  xmlns:xsi="http://www.w3.org/2001/XMLSchema-instance">
  <Collector Version="" Name="TERSUS"/>
  - <Rovers>
    - <Rover ObsFile="xxx.190">
      <Antenna Model="" Height="1.8180"/>
      <RefTime GPSSecond="443435" GPSWeek="2074"/>
      <Points/>
      - <Sites>
        - <Site Reference="" OnPozId="138" Code="Line10" Id="PT174">
          <Position Height="34.8386" Longitude="121.59318585" Latitude="31.19041192"/>
          - <TimeCoverage>
            <StartTime GPSSecond="443435" GPSWeek="2074"/>
            <EndTime GPSSecond="443435" GPSWeek="2074"/>
          </TimeCoverage>
          <StandardDeviation Height="0.0000" Longitude="0.0000" Latitude="0.0000"/>
        </Site>
        - <Site Reference="" OnPozId="138" Code="Line10" Id="PT175">
          <Position Height="34.8386" Longitude="121.59318585" Latitude="31.19041192"/>
          - <TimeCoverage>
            <StartTime GPSSecond="443436" GPSWeek="2074"/>
            <EndTime GPSSecond="443436" GPSWeek="2074"/>
          </TimeCoverage>
          <StandardDeviation Height="0.0000" Longitude="0.0000" Latitude="0.0000"/>
        </Site>
        - <Site Reference="" OnPozId="138" Code="Line10" Id="PT176">
          <Position Height="34.8386" Longitude="121.59318585" Latitude="31.19041192"/>
          - <TimeCoverage>
            <StartTime GPSSecond="443438" GPSWeek="2074"/>

```

change "XXX" to the rover rinex file name

Figure 2.92 Preview of the XML file in text mode

Import the base observation file, rover observation file and the edited XML file to EZSurv application, and EZSurv will identify these files successfully.

2.8 Settings

Settings interface is shown as below, the function descriptions is as follows.

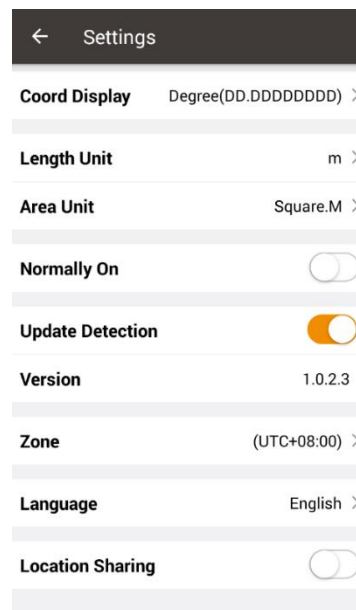

Figure 2.93 Settings interface

[Coord Display]: can be selected from degree (DD.DDDDDDDD), DM (DD:MM.MMMM) or DMS (DD:MM:SS.SS).

[Length Unit]: can be selected from Km, meter, Inch or Feet.

[Area Unit]: can be selected from Mu, Square Km, Square Meter, Hectare and Acre.

[Normally On]: the screen would be always on if it is enabled.

[Update Detection]: Auto update detection is on if it is enabled.

[Version]: the current version of the Nuwa app.

[Zone]: select the time zone according to the current position.

[Language]: support Auto, Chinese, English, French, Spanish, German, Portuguese, Italian, Russian, Japanese, Korean, Malay, Arabic, Thai, and Turkish.

[Location Sharing]: if it is enabled, it will automatically jump to the android system setting interface. Select Nuwa for the mock location app, the location would be shared with other apps.

3. Device

- Connect
- Data Terminal
- Base
- Rover
- NMEA Output
- Device Info

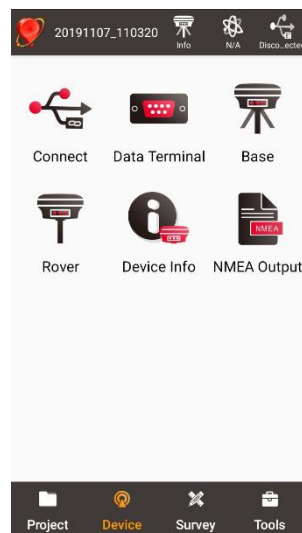



Figure 3.1 Functions under Device

3.1 Connect

There are two ways to enter the Connect interface: Click [Device] -> [Connect] or click

 [Disconnect] on the up right corner in the status bar. Screenshots and descriptions are as follows.

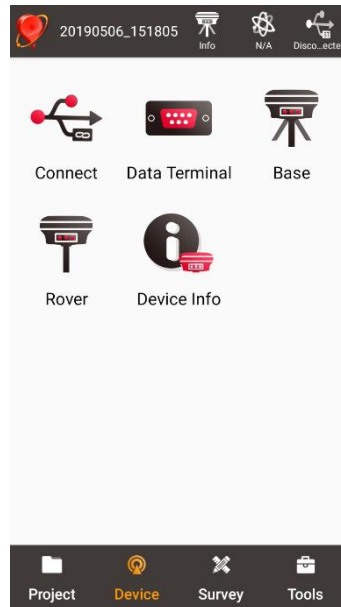

Figure 3.2 Device functional group

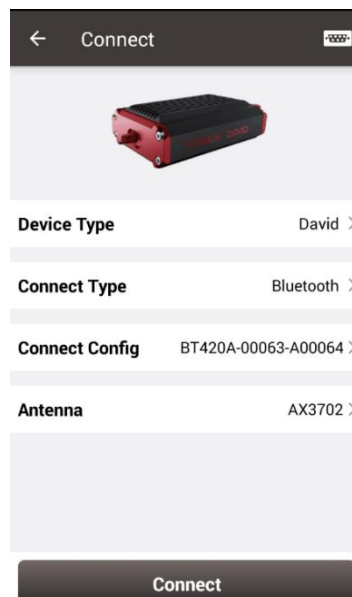

Figure 3.3 Connect interface – David

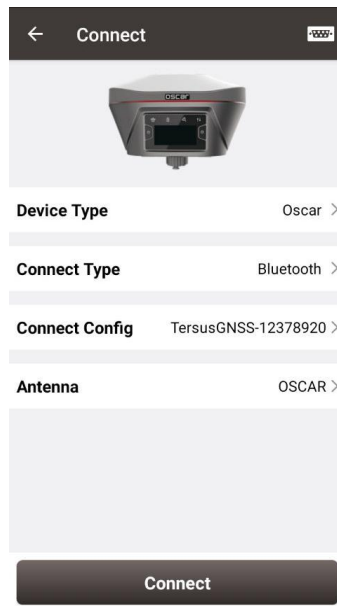

Figure 3.4 Connect interface – Oscar

[**Device Type**]: can be selected from David, Oscar or NMEA¹ devices.

[**Connect Type**]: can be selected from USB or Bluetooth.

[**Connect Config**]: shows the device name to be connected

[**Antenna**]: can be selected from the antenna list. An antenna with user-defined parameters can be added and selected.

Note: NMEA devices should be able to output one of following data: GGA / GSA / GSV / GST / RMC/ RANGEB.

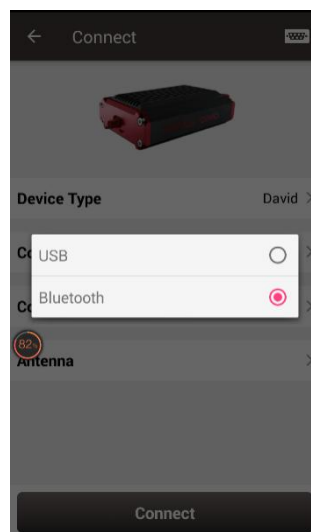

Figure 3.5 Two connection types for David

- USB connection: David can be connected to an android device using a ‘USB Type A Female to USB (Micro+Type C) OTG cable’ in the package. The detailed connection refers to *User Manual for David GNSS Receiver*.
- Bluetooth connection: David can be connected to an android device via wireless method – Bluetooth using ‘COMM1-Bluetooth module’ in the package.
 - 1) Add Bluetooth to the list: select Bluetooth for the [Connect Type], click [Connect Config] and [Search], choose the Bluetooth module to be paired.



Figure 3.6 Bluetooth searching

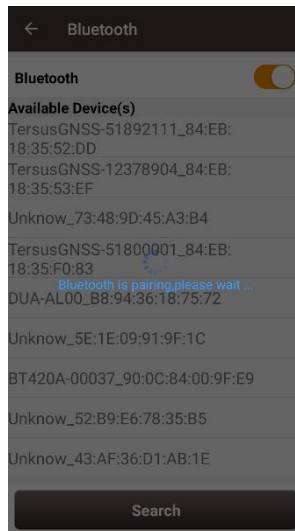

Figure 3.7 Bluetooth is pairing



Figure 3.8 Bluetooth paired

- 2) Remove paired Bluetooth: long press the paired Bluetooth name in the Bluetooth list to remove this paired Bluetooth device in the list.

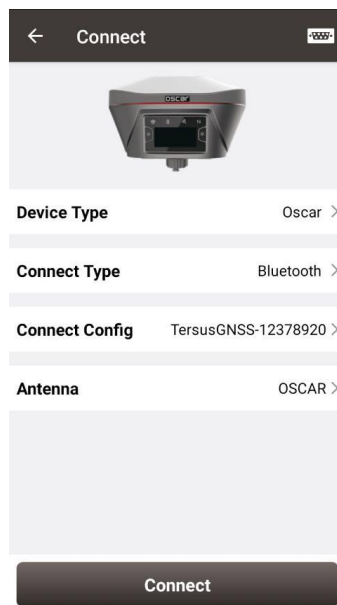

Figure 3.9 Connect interface – Oscar

Currently the connection type for Oscar is Bluetooth only, the other connection types are under development. Stay tuned for the updates. The Bluetooth connection of Oscar is the same with that of David. OSCAR is selected as default antenna for Oscar GNSS Receiver.

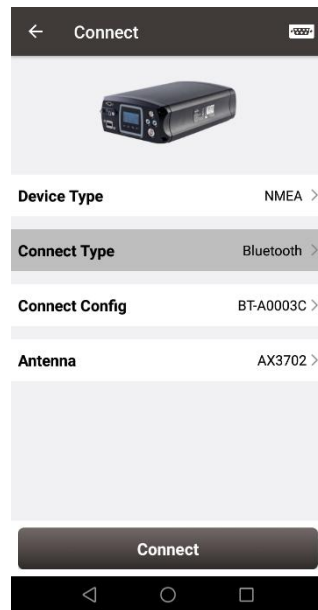

Figure 3.10 Connect interface – NMEA

Currently this connect interface is showing MatrixRTK as an example. In fact, other NMEA devices which support NMEA 0183 can also be connected. For NMEA devices, only Bluetooth is used for connect type.

Click [Antenna] to enter the Antenna Manage interface which is shown as below.

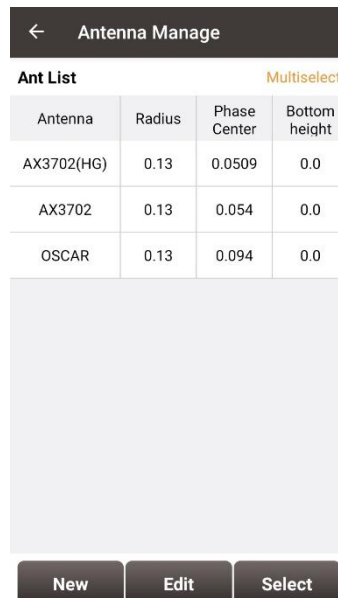

Figure 3.11 Antenna Manage interface

Click [New] in the left bottom corner to add new antenna parameters which is shown as below.

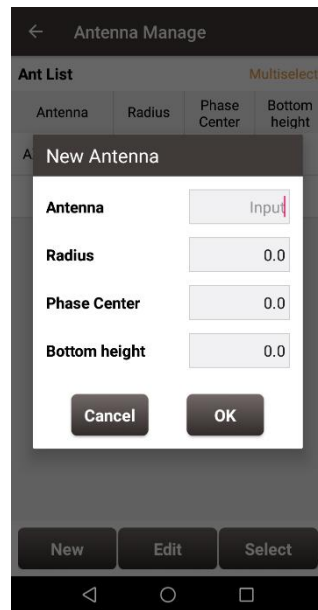

Figure 3.12 Parameters for New Antenna

[Antenna]: input the antenna name for the new antenna.

[Radius]: input the radius of the new antenna when measuring the slant height. Input 0.13 when using the height measure accessory provided by Tersus.

[Phase Center]: input the height from the antenna phase center to the antenna bottom.

[Bottom height]: input the height from the antenna circumference to the antenna bottom.

Note: the unit for the above three parameters is meter (m).

The following figure explains the above three parameters taking AX3702 antenna for example. R: Radius; P: Phase center; B: Bottom height.

Antenna Phase Center

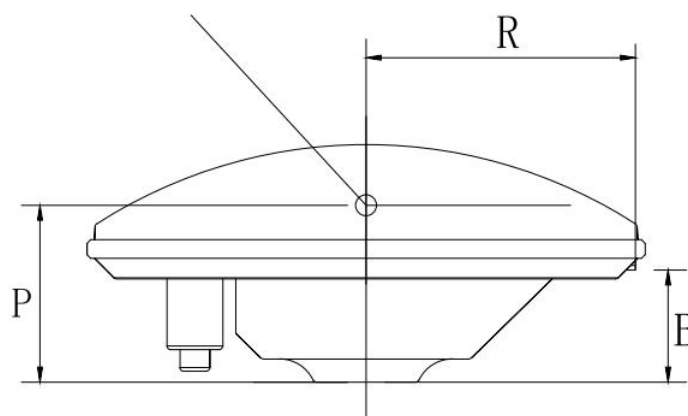

Figure 3.13 Antenna parameters explanation

3.2 Data Terminal

In the data terminal interface, the output loggings can be monitored as shown below. It is outputting ASCII data when David is connected with AX3702 GNSS antenna and it is working normally.

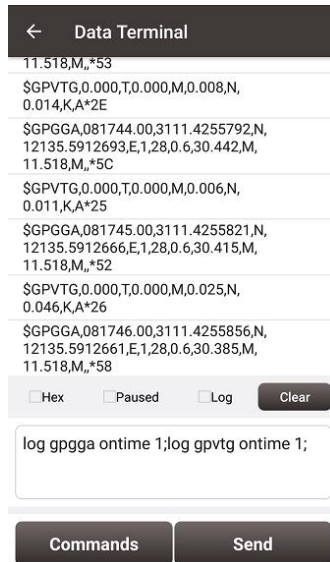

Figure 3.14 Data Terminal interface

Check the box on the left of [Hex] to enable the above window output hex data which is shown below.



Figure 3.15 Data Terminal outputs hex data

Check the box on the left of [Paused] to pause the output logging.

Check the box on the left of [Log] to start recording log data. The log data is saved in a .txt file. Create file name in the pop-up window as shown below.

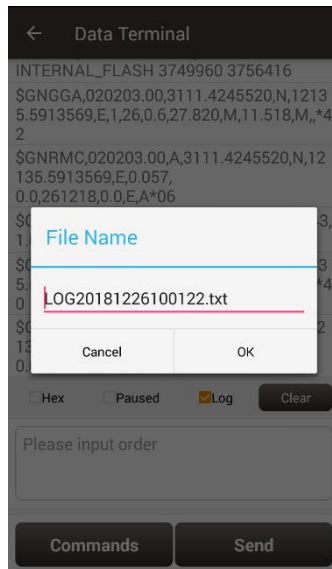

Figure 3.16 Create File Name

Click [OK] to confirm the file name, it automatically starts recording log data and stores the data in the default folder /storage/emulated/0/TersusSurvey/GpsLogger/xxxxxx.txt.

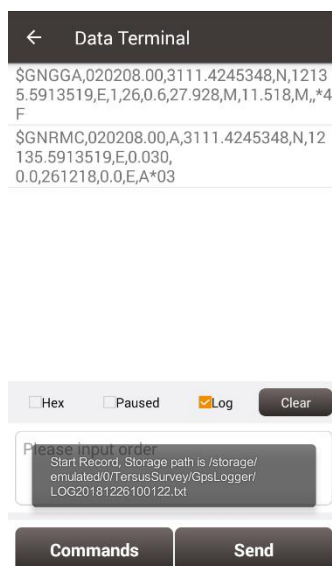

Figure 3.17 Start recording log data

Uncheck the box on the left of [Log] is to stop recording log data.

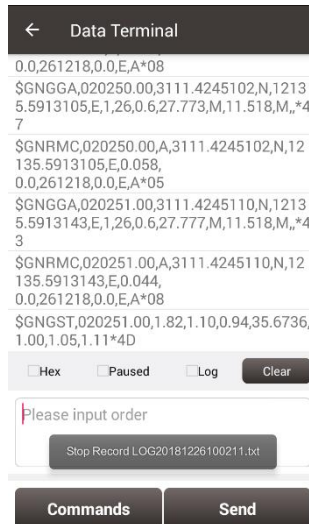

Figure 3.18 Stop recording log data

Click [Clear] to clear the screen.

Click [Commands] to output common NMEA loggings (not available for connecting Oscar).

Check the commands and click [OK], it will return to the command window with the typed commands which is shown in Figure 3.14. Then click [Send] to send the commands to communicate with Tersus receivers.

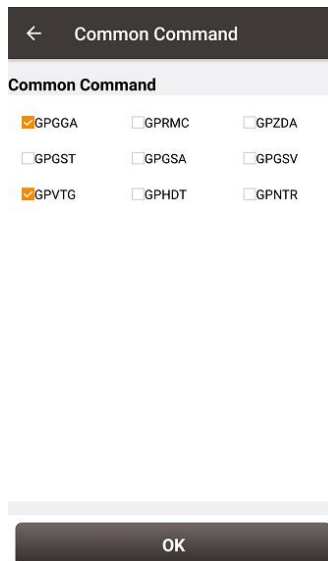

Figure 3.19 Common Command

The detailed description of log and command refers to *Log & Command Reference for Tersus BX GNSS OEM boards* which can be downloaded on Tersus website.

Note: [Commands] and [Send] are not available when Nuwa is connected with Oscar.

3.3 Base

Some default base configurations are provided for David and Oscar. Select a configuration file in the Work Mode List and click [Detail] to edit the base configuration. Click [Start] to complete the base configuration.

[Startup]: auto start or manual start

- Auto start: the position of the base is achieved automatically.
- Manual start: base coordinate is achieved by averaging collection, loaded from a point library or input manually.

[Data Link]: radio or network for **David**.

- Radio: the corrections are output to an external radio, serial baud rate should be selected accordingly.
- Network: the corrections are uploaded to a Ntrip server or TCP host. The IP address, port, password and mount point of the Ntrip server should be input manually; The IP address and port of the TCP host should be input.

Four options for data link of **Oscar**.

- External Radio: the corrections are transmitted via 25W radio for Oscar.
- Internal Radio: the corrections are transmitted via internal 2W radio of Oscar. Oscar internal radio currently supports three transmit powers of 0.5W, 1W, and 2W, and supports five protocols, TransEOT, TT450, SOUTH, SATEL, and TRIMMK3, and two corresponding air baud rates 9600bps and 19200bps. Each protocol supports ten channels and customized frequency. Select 0~9 channel on Nuwa will automatically read the corresponding frequency to the channel.
- Receiver Network: the corrections are uploaded to Ntrip server or TCP host, or Tersus Caster Service (TCS) using Oscar network. The IP address, port, password and mount point of the host should be input manually.

- PDA Network: the corrections are uploaded to Ntrip or TCP host, or Tersus Caster Service (TCS) using a PDA device. The IP address, port, password and mount point of the host should be input manually.

[Baud Rate]: the serial baud rate can be selected from 9600 to 921600, the default is 38400bps for David and 115200bps for Oscar. The air baud rate for Oscar internal radio can be selected from 9600 and 19200.

[Differential Format]: CMR, CMR+, RTCM2.3, RTCM3.0 and RTCM3.2 are supported for David; RTCM2.3, RTCM3.0 and RTCM3.2 are supported for Oscar.

3.3.1. Set David as a Base

The detailed description for each configuration of **David** as a base is shown in below screenshots.

Click [New] to create a new base configuration. In the figure below, for auto start in radio mode, baud rate is 38400 by default and can be selected in the pop-up list below. The differential format is RTCM3.2 by default.

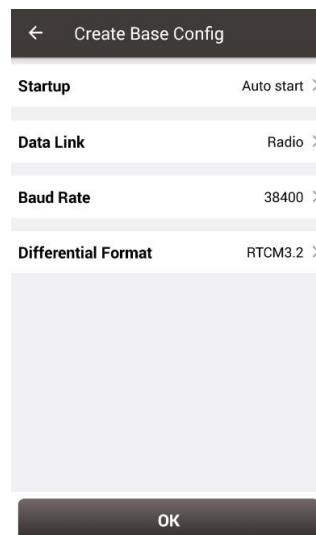

Figure 3.20 David base auto start – Radio

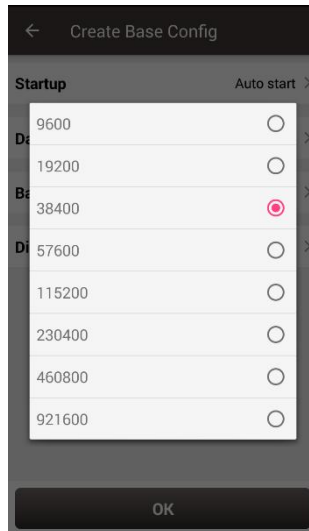

Figure 3.21 Baud rate options

The detailed information of how to use radio refers to *User Manual for David GNSS Receiver*.

In the figure below, for auto start in network mode, the host IP can be manually typed or selected by clicking the icon **IP** on the right of row Host. It shows two Ntrip servers built by Tersus GNSS Inc. and can be selected depending on different area. The site list can be added, edited and deleted. For Ntrip network, host IP, port, password and mount point should be input. For TCP network, host IP and port should be input. Contact Tersus technical support for password and mount point information if you bought products from Tersus.

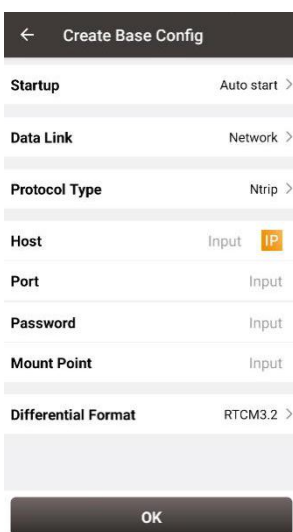

Figure 3.22 David base auto start – Ntrip

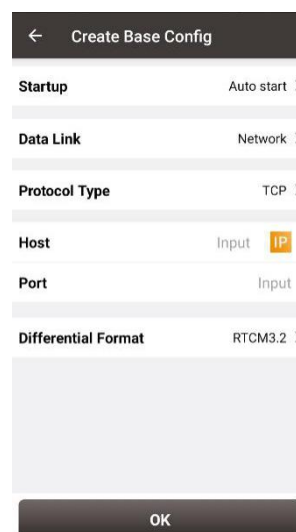

Figure 3.23 David base auto start – TCP





Figure 3.24 Ntrip Site Manager

Ntrip status viewing method when the base station is connected to Ntrip server:

Take asiacaster for example, open any browser on the computer (accessible to internet) and enter the following URL in the address bar:

<http://asiacaster1.tersus-gnss.com:2201/Ntrip.html?usr=username&pwd=password>

in which, the **username** and **password** should be obtained from Tersus GNSS Inc.

In the figure above, for manual start in radio mode, the base coordinate should be typed manually or obtained by clicking  the location icon or imported from the survey point library by clicking  the list icon. The other parameters setting is the same with that in auto start radio mode.

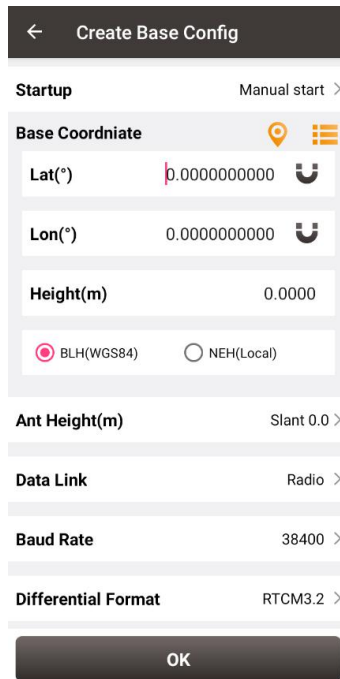

Figure 3.25 David base manual start – Radio

In the figure below, for manual start in network mode, the base coordinate setting is the same with the method mentioned above, the network host setting is the same with the method described for auto start in network mode.

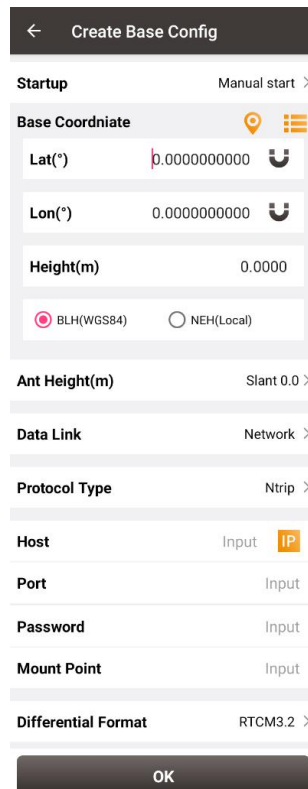

Figure 3.26 David base manual Start – Network

3.3.2. Set Oscar as a Base

The detailed description for each configuration of **Oscar** as a base is shown in below screenshots.

Click [New] to create a new base configuration.

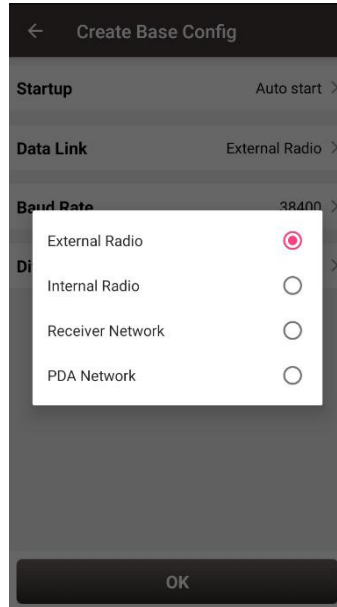

Figure 3.27 Oscar base auto start – 4 data link options

- External Radio: the configuration method of Oscar base with external radio is similar with that of David base with radio stated above. The difference is that the default serial baud rate of Oscar 25W radio is 115200bps.
- Internal Radio: if choosing to use the internal radio of Oscar, user needs to select proper air baud rate, transmitting power, protocol, channel and frequency.

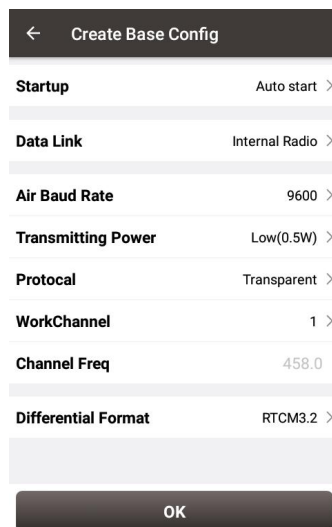

Figure 3.28 Oscar base auto start – internal radio

- Receiver Network: if choosing to use receiver network to transmit corrections, there are three protocol options to select: Ntrip, TCP and TCS (Tersus Caster Service). Fill in the corresponding IP address, port, password, mount point and base ID if necessary to connect to the receiver network.

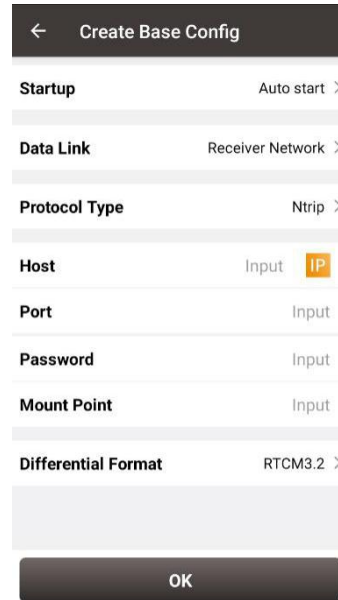
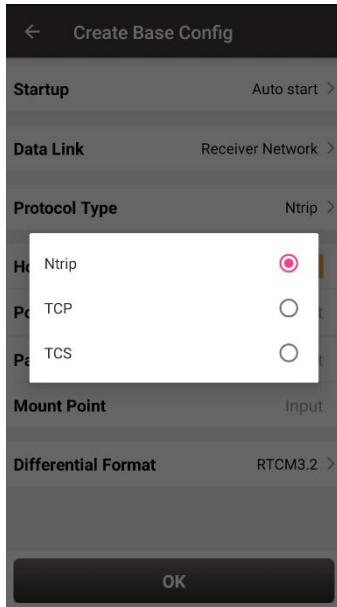

Figure 3.29 Oscar base auto start – receiver network options

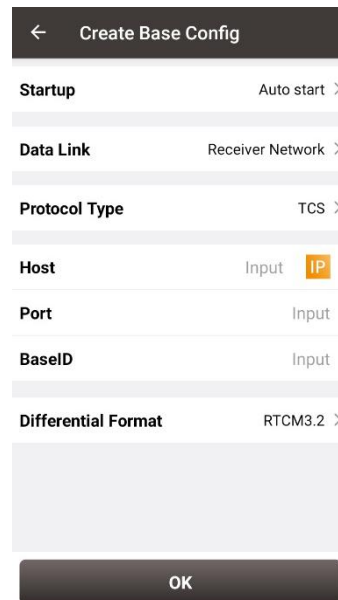
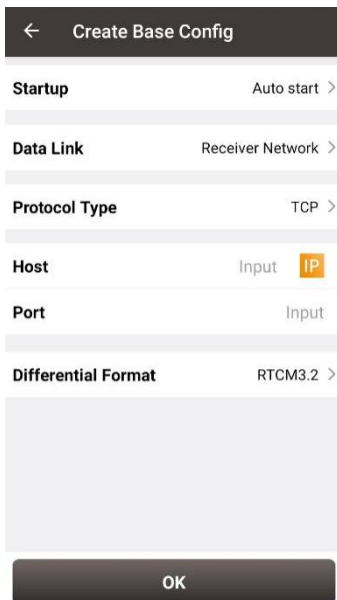

Figure 3.31 Oscar base auto start – TCP network

Figure 3.32 Oscar base auto start – TCS network

- PDA Network: there are also three protocol options of PDA network to select: Ntrip, TCP and TCS (Tersus Caster Service). The required information to input for different protocol is different, refer to the screenshots above.

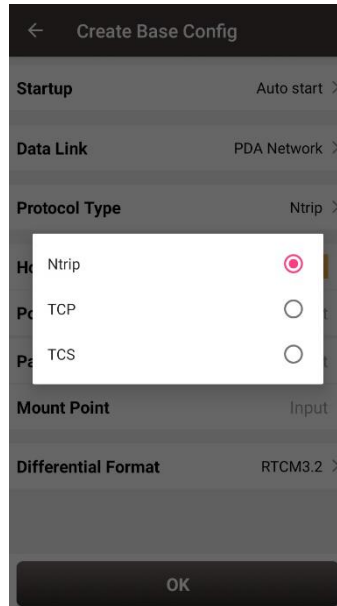



Figure 3.33 Oscar base auto start – PDA network options

For Oscar manual start in radio mode and network mode, the base coordinate should be typed manually or obtained by clicking  the location icon or imported from the survey point library by clicking  the list icon. The data link options configuration are the same with the method mentioned above in Oscar base auto start in radio and network modes.

3.4 Rover

Some default rover configurations are provided for David and Oscar. Select a configuration file in the Work Mode List and click [Detail] to edit the rover configuration. Click [Start] to complete the rover configuration.

3.4.1. Set David as a Rover

The detailed description for each configuration of **David** as a rover is shown in below screenshots.

Click [New] to create a new rover configuration. In Figure 3.34 below, for rover configuration in radio mode, the baud rate is 38400 by default and can be selected from 9600 to 921600 in the pop-up list as shown in Figure 3.21.

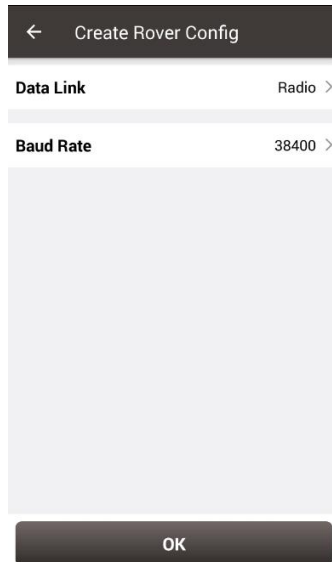

← Create Rover Config

Data Link Radio >

Baud Rate 38400 >

OK

Figure 3.34 Create Rover Configuration for David – Radio

In Figure 3.35 below, for rover configuration in network mode, the protocol type can be selected from Ntrip and TCP.

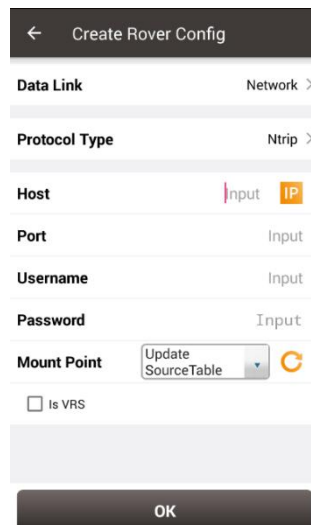

← Create Rover Config

Data Link Network >

Protocol Type Ntrip >

Host Input IP

Port Input

Username Input

Password Input

Mount Point Update SourceTable

Is VRS

OK

Figure 3.35 Create Rover Configuration for David – Ntrip Network

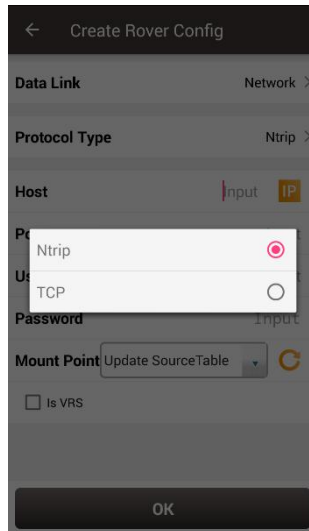



Figure 3.36 Protocol type options

When Ntrip network is selected, the host can be manually typed or selected by clicking the icon  on the right of row Host as mentioned in Figure 3.24 above. The username and password should be obtained from Tersus technical support. The box on the right of Mount Point displays the mount point and differential format after clicking the refresh icon  to update the source table. The example is shown below.

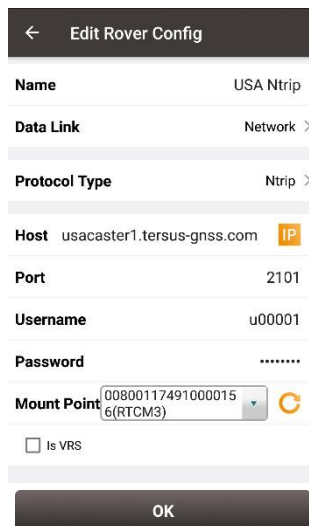
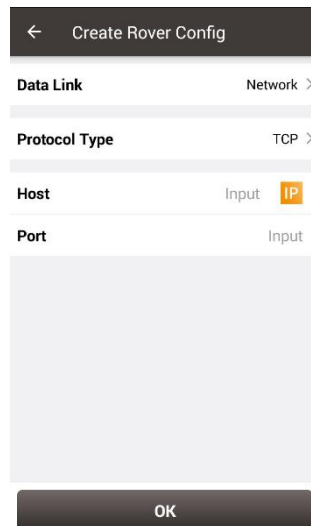

Figure 3.37 Edit Rover Configuration

When TCP is selected for protocol type, fill in the information of host and port according to customer requirements to complete the configuration.



| Create Rover Config | |
|---------------------|-----------|
| Data Link | Network > |
| Protocol Type | TCP > |
| Host | Input IP |
| Port | Input |
| OK | |

Figure 3.38 Create Rover Configuration for David – TCP Network

3.4.2. Set David as a Rover

The detailed description for each configuration of **Oscar** as a rover is shown in below screenshots.

Click [New] to create a new rover configuration. It shows the rover configuration using the internal radio of Oscar as below. Choose appropriate baud rate, communication protocol, work channel and channel frequency. Click [OK] and type the configuration name to complete creating a rover configuration of Oscar.

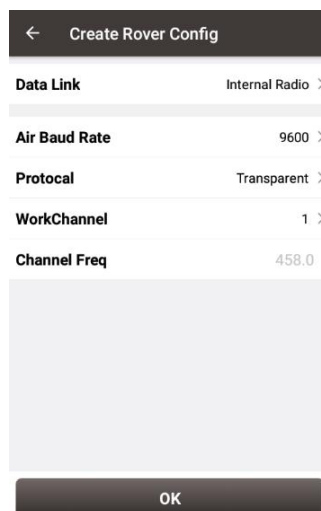

| Create Rover Config | |
|---------------------|------------------|
| Data Link | Internal Radio > |
| Air Baud Rate | 9600 > |
| Protocol | Transparent > |
| WorkChannel | 1 > |
| Channel Freq | 458.0 |
| OK | |

Figure 3.39 Create Rover Configuration for Oscar – Internal Radio

The data link can be selected from an option list: Internal Radio, Receiver Network and PDA Network shown as below.

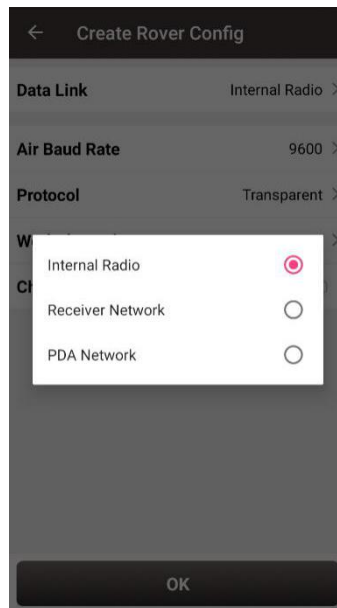

Figure 3.40 Oscar rover data link options

When Receiver Network is selected for Oscar rover communication, there are three protocol options to select: Ntrip, TCP and TCS (Tersus Caster Service). Fill in the corresponding host, port, password, mount point and base ID if necessary to connect to the receiver network.

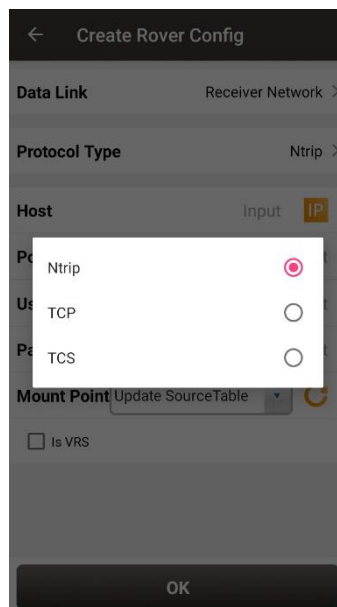

Figure 3.41 Oscar rover using receiver network – protocol options

When PDA Network is selected for Oscar rover communication, there are also three protocol options of PDA network to select: Ntrip, TCP and TCS (Tersus Caster Service).

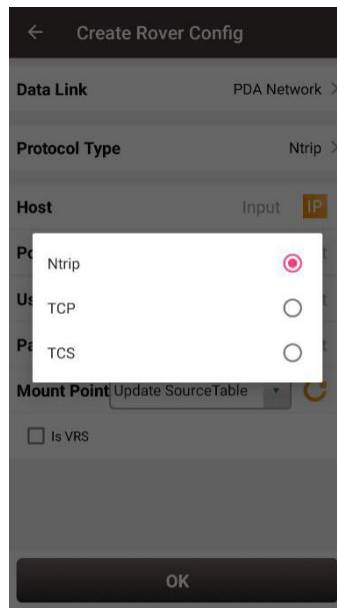

Figure 3.42 Oscar rover using PDA network – protocol options

3.5 NMEA Output

The NMEA output function is only available when Oscar receiver is connected. The serial config can be turned on or off. The baud rate can be selected in the pop-out list from 9600 to 921600 bps. The NMEA data which needs to be output via serial port can be checked.

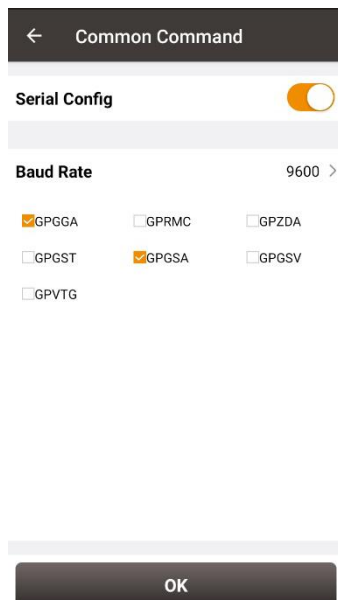

Figure 3.43 NMEA output configuration

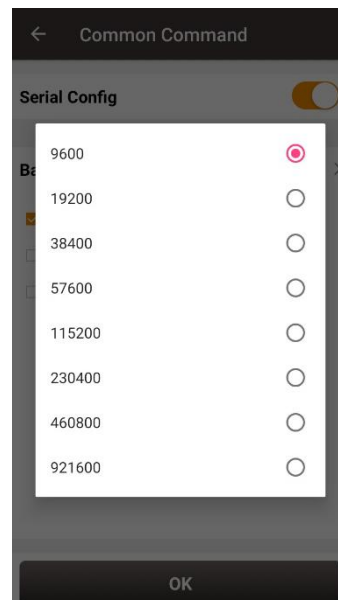

Figure 3.44 NMEA baud rate options

3.6 Device Info

Under the Device functional group, click [Device Info] to check the detailed information about the device connected.

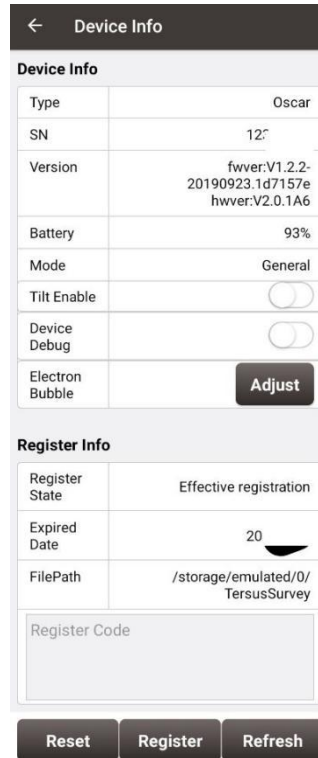

Figure 3.45 Device Info interface

In the figure above, the SN row displays complete serial number for David, while only displays 8 digits number for Oscar which is used for Bluetooth pairing, registration, TCS connection, and etc. The battery row displays remaining battery level for Oscar, not for David. The mode row displays current working mode, which includes General, Base and Rover.

When the David receiver has an unknown error, turning on Device Debug to record Tersus specific data to troubleshoot receiver which can help us better improve receiver's function.

Note: This function and static survey cannot be turned on at the same time. Please manually turn off the static survey before using Device Debug. This function is not applicable for Oscar.

Electronic Bubble (eBubble)

This function is only available for Oscar GNSS Receiver. Make the body of Oscar stand on a leveled Tribrach before eBubble calibration.

Click **Adjust** on the right of electronic bubble to adjust bubble. On the screenshot below, the eBubble is not in the black circle and its color is red for warning purpose.

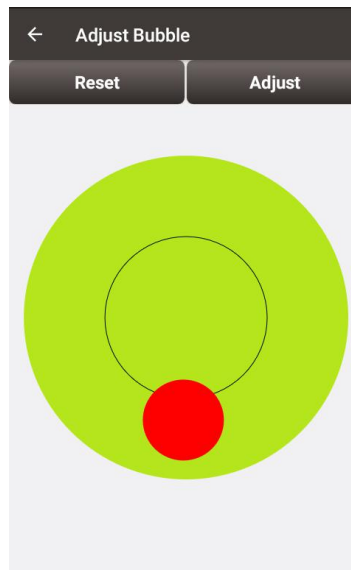

Figure 3.46 eBubble before adjusting

Click **Adjust** on the right, the eBubble is calibrated to the center inside the black circle and the bubble color turns blue.

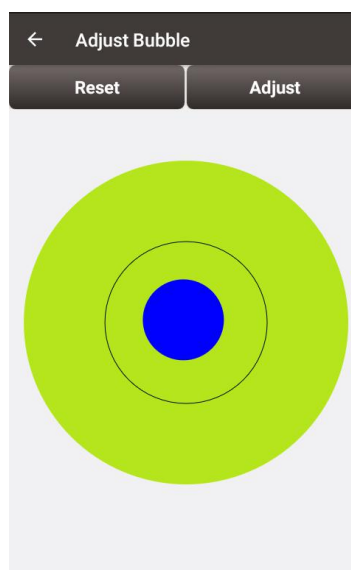

Figure 3.47 eBubble after adjusting

When the registration is not effective, click [Register] after putting the registration file (obtained from Tersus Technical Support) into the specified FilePath /storage/emulated/0/TersusSurvey, then click [Refresh] to update the registration status.

Clicking [Reset] resets the receiver into factory settings.

4. Survey

- Survey
- Point Stakeout
- Line Stakeout
- Static Survey
- Point Correction
- Survey Config
- Base Shift

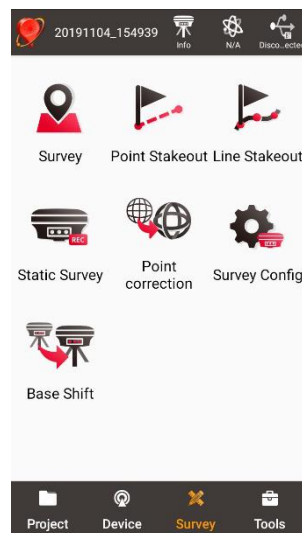

Figure 4.1 Functions under Survey

4.1 Survey

The Survey interface includes: status bar, background map, tools and information.

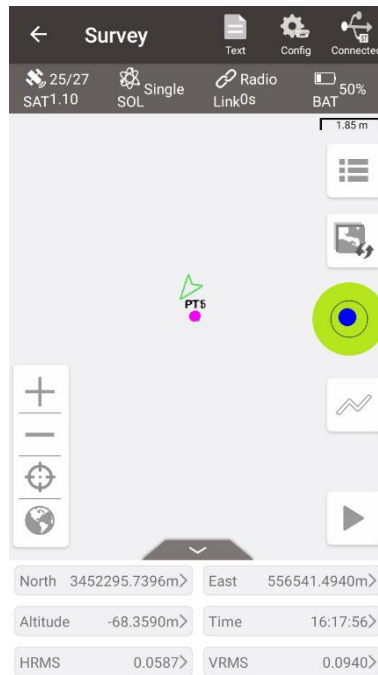

Figure 4.2 Survey – Drawing mode

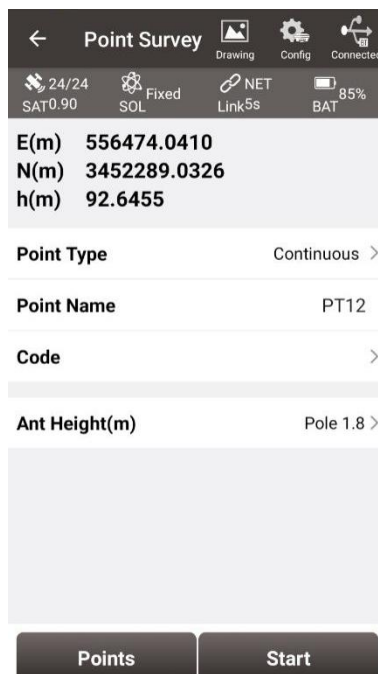

Figure 4.3 Survey – Text mode

➤ Status Bar



[Text]: the main interface is shown in text mode or drawing mode, click this icon to switch between the two modes.



[Config]: Survey Configuration, refer to section 4.6 for more details.



[Connected]: connection status with a Tersus GNSS receiver, refer to Connect for more details.



[SAT 1.30]: number of satellite traced, e.g., 23 means 23 satellites are used, 24 means 24 satellites are tracked, and 1.30 indicates the PDOP value.



[Fixed SOL]: solution status, includes Single, Float, Fixed, DGPS and Base.



[Link2s NET]: the upper right word indicates the data link type: radio or network; the lower right time is the latency of the data link.



[BAT 99%]: indicates the remaining battery power of Oscar GNSS receiver. Currently it is not supported of displaying the battery of David as there is no embedded battery in David receiver.

➤ Background Map



[Library icon]: view and edit the survey point library.



[Map icon]: click it to switch among none, OSM online map, Google online map and Google online map (China).



[+]: zoom in the map.



[-]: zoom out the map.



[Home icon]: zoom with the current location at the center.



[Globe icon]: place all the points in one view.

➤ Tools



[Electronic bubble icon]: electronic bubble: indicates leveling bubble calibration status. The bubble is blue when it is calibrated to the center inside the black circle, and is red when it is not calibrated to the center circle.

: Linework function: After clicking this icon, enter the line name and other information. Click [OK] and the hollow line becomes a solid line in the icon. Then it starts collecting the survey points (including continuous points and smooth points) which will be connected into a line. The line is saved in the line list. When the acquisition is completed, click again this icon. The icon changes back to the initial state and ends line acquisition. After this, the collecting survey points will not be connected to the line.

If entering the existing line name instead of a new one, it supports to continue the linework survey selecting from start or from end point.

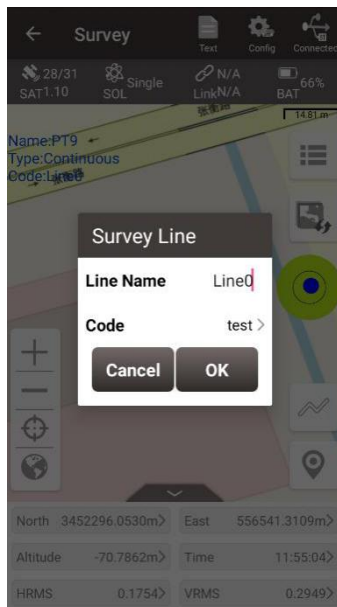

Figure 4.4 Enter an existing line name

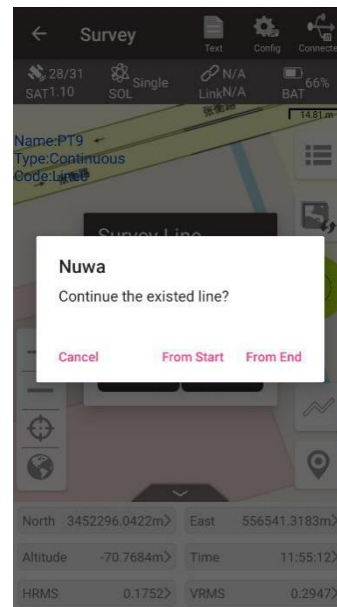



Figure 4.5 Continue the existing line options

After survey points are collected, information in blue color is displayed at the up left corner. There are two methods to collect survey points:

: Auto collect when selecting continuous for survey mode, refer to section 4.6.1 Common Config for more details.

: Manual collect, it will display this icon when selecting detail for survey mode.

➤ Information Bar

Six information items are displayed, each can be chosen from the 18 items in the following screenshots.

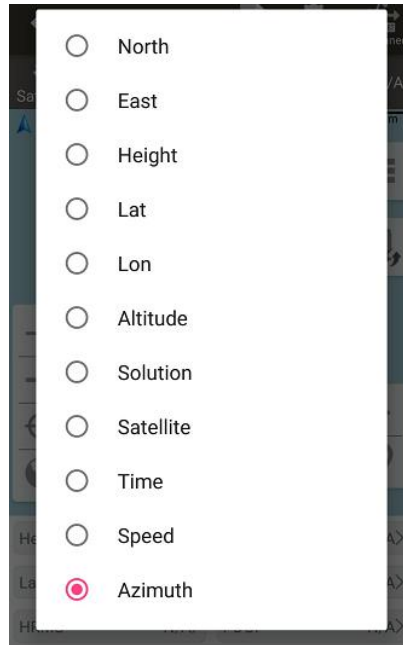

Figure 4.6 Information option list – part 1

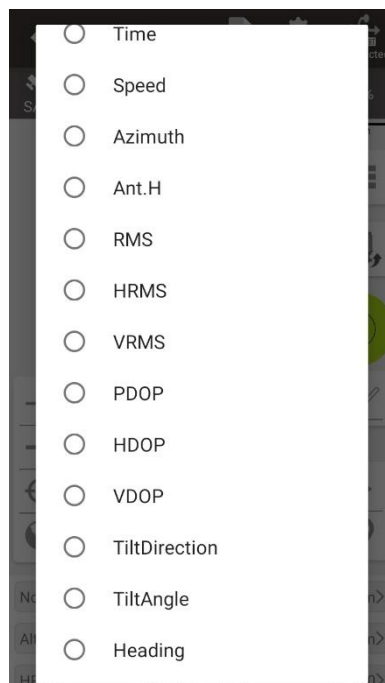

Figure 4.7 Information option list – part 2

4.2 Point Stakeout





Figure 4.8 Point Stakeout interface

The above screenshot is the main interface of point stakeout, which is similar to that of point survey.

The main steps of point stakeout are as follows:

- Add stakeout point: click  to enter the stakeout point library which is shown in Figure 4.9 below, refer to section 2.4 for point library management.
- Select the point to be stakeout: select the point, then click [Select].
- The offset between the current point and the target point is displayed on the screen.

The arrow icons  and  are used to switch the stakeout points in the library.

| ← Stakeout Point | | |
|------------------|------|--------------|
| 5 features | | Multiselect |
| id | Name | N |
| L5 | SPT1 | 3452290.9209 |
| L2 | SPT2 | 3452290.9220 |
| L3 | SPT3 | 3452290.9269 |
| L4 | SPT4 | 3452290.9225 |
| L6 | SPT9 | 3452248.6325 |

| | | | |
|-----|------|--------|--------|
| Add | Edit | Import | Select |
|-----|------|--------|--------|

Figure 4.9 Add stakeout point

In the point stakeout interface,

- The red flag indicates the location of the stakeout point.
- The red dotted line is the connection between the current point and the point to be staked.
- The green arrow is the point to be staked.
- The green arrow pointing towards the surveyor heading.
- The blue arrow prompts the surveyor that the point to be staked is in the front/rear/left/right position.
- The blue number shows the distance from the point to be staked in different directions.

4.3 Line Stakeout



Figure 4.10 Line Stakeout interface

The above screenshot is the main interface of line stakeout, which is similar to that of point survey. The main steps are as follows:

- Click to enter stakeout line library shown as below. Click [Add] to add a new stakeout line or click [Detail] at an existing stakeout line to edit the stakeout line.

| Name | Start Point | End Point | Leng |
|------------|-------------|-----------|--------------|
| StakeLine0 | PT1 | Base_0 | 349686; 9 |



Figure 4.11 Enter stakeout line library

| | |
|-----------------------|-------------------------------------|
| Line Type | Line > |
| Method | Two point form > |
| Name | StakeLine0 |
| Start Point | PT1 |
| End Point | PT2 |
| Start Mileage | 0.0 |
| Point On Line Staking | <input checked="" type="checkbox"/> |
| Stakeout Interval(m) | 1 |
| Offset(m) | 0.0 |
| Describe | <input type="text"/> |
| OK | |

Figure 4.12 Edit an existing stakeout line

In the above screenshot of line detail,

[Line Type]: line is the only line type currently.

[Method]: two methods to add a stakeout line, details refer to section 2.5.1.

[Name]: the line name can be modified manually.

[Start Mileage]: the mileage at the starting point, used to calculate mileage at subsequent points.

[Point On Line Staking]: when this button is turned on, stake out points on the line (or offset line) according to the entered Interval and Offset; when this button is turned off, stake out directly to the line, that is, stake out to the vertical cross point of the current position and the selected line.

[Stakeout Interval (m)]: the interval distance of the points on the stakeout line, which means stake out a point every certain distance.

[Offset (m)]: the offset when staking out the points on the stakeout line. When it is negative, it is to the left of the line forward direction. When it is positive, it is to the right of the line forward direction.

- Select the stakeout line, click [Select].
- Stake out from the starting point (+ offset), stake out the next point every interval distance. The distance from the current position to the target position will be displayed on the screen

4.4 Static Survey

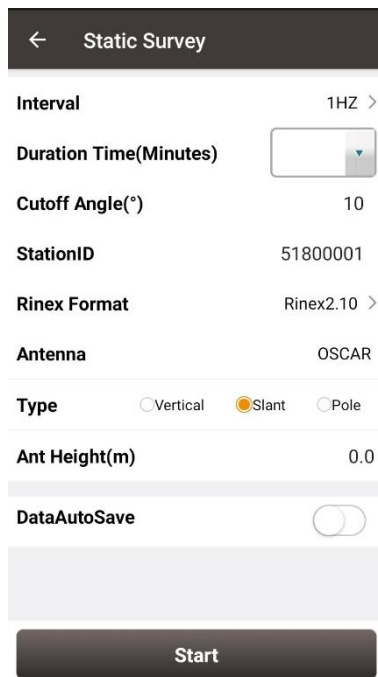

Static Survey

Interval 1HZ >

Duration Time(Minutes) [input field]

Cutoff Angle(°) 10

StationID 51800001

Rinex Format Rinex2.10 >

Antenna OSCAR

Type Vertical Slant Pole

Ant Height(m) 0.0

DataAutoSave

Start

Figure 4.13 Static Survey interface

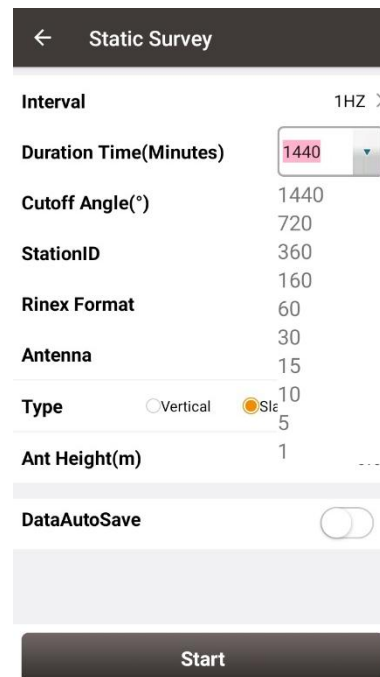

Static Survey

Interval 1HZ >

Duration Time(Minutes) 1440 [dropdown menu]

Cutoff Angle(°) 1440

StationID 360

Rinex Format 160

Antenna 60

Antenna 30

Antenna 15

Type Vertical Slant Pole

Ant Height(m) 10

Ant Height(m) 5

Ant Height(m) 1

DataAutoSave

Start

Figure 4.14 Duration options

[Interval]: selected from 10HZ, 5HZ, 1HZ, 5S and 10S. The max rate is determined by the device connected.

[Duration Time (Minutes)]: static survey duration, the recording time can be selected in the drop down list or typed manually.

[Cutoff Angle]: the elevation mask angle, usually set to 15°.

[StationID]: the name of the surveying station.

[Rinex Format]: selected from Rinex2.10, Rinex3.02, and NONE. If configure using Nuwa, it will save trs file by default.

[Antenna]: the antenna type.

[Type]: selected from vertical, slant or pole.

[Ant Height]: the height of the antenna.

[DataAutoSave]: if this function is turned on, when the static recording time reaches the set duration, Oscar closes the current file record, reopens a file to continue recording, and this cycles; Oscar will also reopen a file to continue recording static when restart. If this

function is turned off, Oscar will stop static recording when the recording time reaches the set duration.

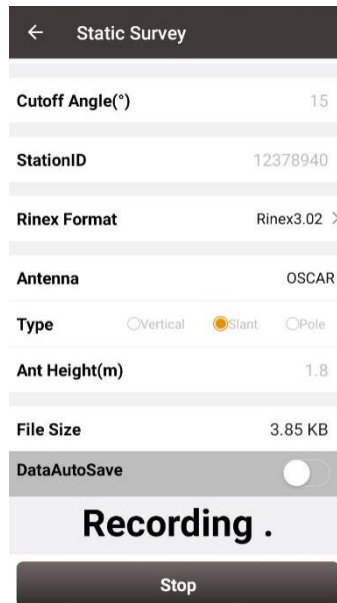

Figure 4.15 Static data recording

After all the parameters are confirmed, click [Start] to start data collection. The static data is recording as shown in Figure 4.15.

Note: Static Survey and Device Debug cannot be used at the same time. Please turn off Device Debug as shown in Figure 3.45 Device Info interface manually before recording static data.

Static data download and post-processing

4.4.1 Static data download for David

Device preparation

- A David GNSS receiver
- A DC-2pin to USB power cable
- A COMM2-7pin to USB & DB9 cable
- A power bank
- A computer running TersusDownload tool



Figure 4.16 Preparation for Static Data Process

After the static survey in fields is completed, connect the David receiver to the computer according to the following figure and power on the David receiver. The USB port is mapped to a serial port (COM5 in the following example) in the computer, which can be checked in the Device Manager.



Figure 4.17 Connections of David, computer and power bank

It is recommended to type UNLOGALL in the command window of Tersus GNSS Center software before executing below steps. Open the TersusDownload on the computer, select the serial port to communicate with the David receiver.

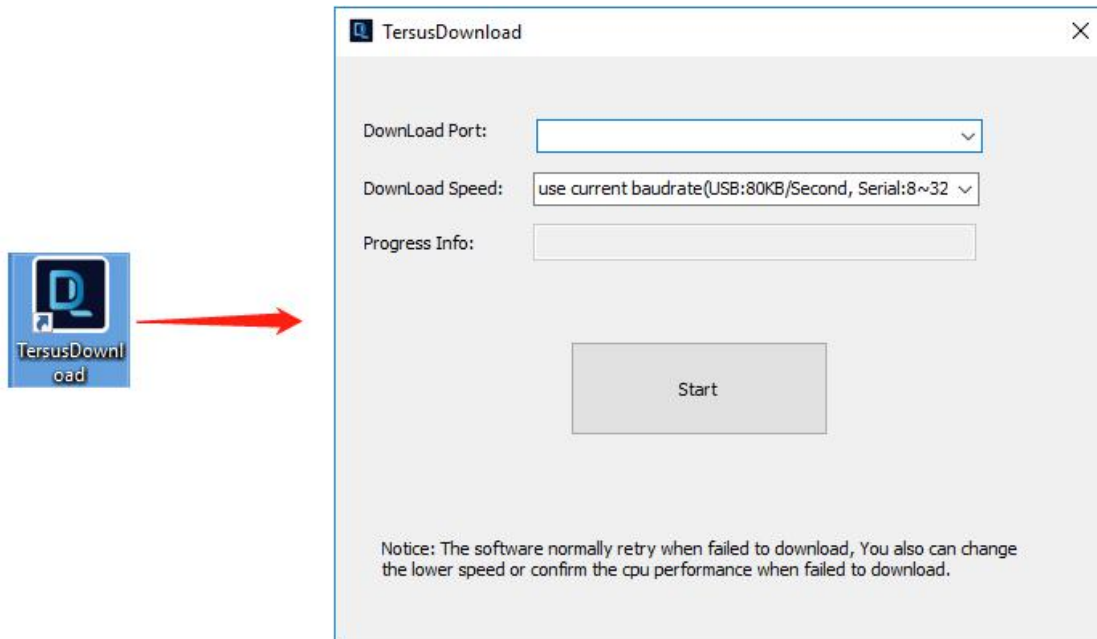

Figure 4.18 TersusDownload interface

Select the download speed. Select 'use current baudrate' when using USB port to download files as shown below. Select baud rate 460800bps if a serial port is used to download files.

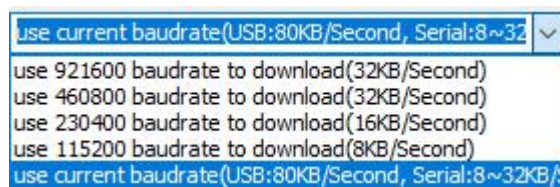

Figure 4.19 Download speed options

After completing the above steps, click [Start] and it pops out below window. Select the DownloadPath, select the files to be downloaded, click [Download] to start downloading:

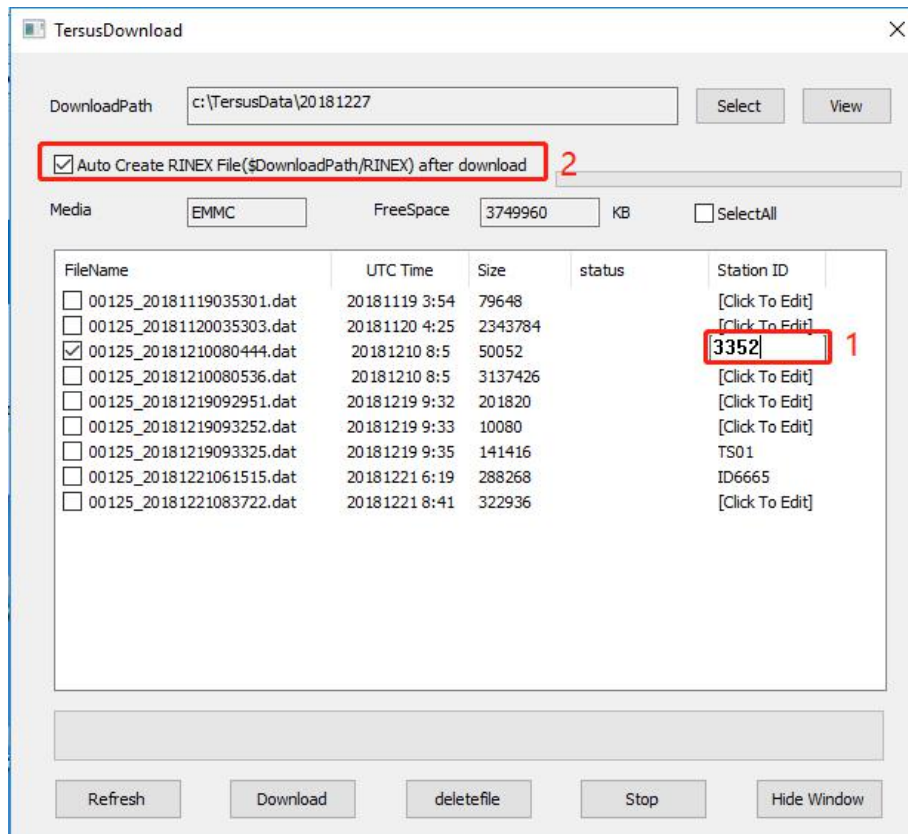

Figure 4.20 File selected for download

In this interface, click the number in red box 1 to edit Station ID if necessary, or it can be edited in Figure 4.13 in section 4.4 Static Survey. Check the box in the left of red box 2 to enable or disable auto create RINEX file after download.

| | |
|---|---|
| ! | The downloading rate is about 2MB/min, the downloading time can be estimated based on it. |
| ! | It is recommended to ensure the computer has available CPU and memory when downloading files. |

Open the RINEX file using notepad or other text viewing software, the antenna height is vertical height which is from the phase center of the antenna to the point on the ground. The value of the antenna height can be found as shown below.

```

3.02 OBSERVATION DATA M (MIXED) RINEX VERSION / TYPE
Tersus Tersus 2019-03-19 10:12 PGM / RUN BY / DATE
Test MARKER NAME
Tersus MARKER NUMBER
Tersus OBSERVER / AGENCY
TRSAX3702 NONE REC # / TYPE / VERS
-2860999.0400 4651726.0655 3283992.2949 ANT # / TYPE
1.0375 APPROX POSITION XYZ antenna height
1.000 ANTENNA: DELTA H/E/N
G 8 C1C L1C D1C S1C C2P L2P D2P S2P INTERVAL
C 8 C1I L1I D1I S1I C7I L7I D7I S7I SYS / # / OBS TYPES
R 8 C1C L1C D1C S1C C2P L2P D2P S2P SYS / # / OBS TYPES
2019 3 19 9 38 19.0000000 GPS TIME OF FIRST OBS
2019 3 19 10 12 3.0000000 GPS TIME OF LAST OBS
END OF HEADER
> 2019 03 19 09 38 19.0000000 0 24
G01 20477692.414 107611001.758 1744.113 46.000 20477694.438 83852737.918 1359.066 47.000
G07 20644342.445 108486749.574 -771.430 46.000 20644342.602 84535126.090 -601.168 44.000
G08 21771518.555 114410099.551 -1845.258 45.000 21771520.914 89150736.824 -1437.852 43.000
G11 20218292.344 106247839.395 437.070 44.000 20218290.375 82790516.031 340.543 39.000
G16 24614137.047 129348152.883 -2549.102 35.000 24614137.047 100790757.469 -1986.465 20.000
G18 20084844.078 105546570.480 -180.441 45.000 20084844.602 82244079.199 -140.668 39.000
G22 23999749.844 126119558.992 2465.613 38.000 23999748.195 98274979.070 1921.180 26.000
G27 24046037.734 126362774.551 -2662.340 38.000 24046039.195 98464502.613 -2074.566 39.000
G28 23831380.477 125234751.008 2417.512 40.000 23831378.719 97585516.570 1883.742 25.000
G30 21610795.938 113555496.465 1380.316 45.000 21610798.203 88492604.246 1075.527 43.000
C01 36967716.523 192500600.000 10.000 44.000 36967709.789 148853647.844 7.664 47.000
C02 38306562.961 199472321.852 20.707 39.000 38306558.727 154244635.484 16.035 44.000
C03 36909363.773 192196740.523 6.414 45.000 36909361.086 148618701.039 4.969 46.000
C04 38123486.313 198518996.797 15.398 42.000 38123483.750 153507470.684 11.938 45.000
C07 35729677.038 186053801.926 245.375 46.000 35729672.734 143868586.336 189.785 47.000
    
```

Figure 4.21 View antenna height in the RINEX file

4.4.2 Static data download for Oscar

Device preparation

- An Oscar GNSS receiver
- A mini USB cable
- A computer running RinexConverter tool

Before connecting Oscar to a computer, ensure Oscar is powered on. Use the Mini USB Cable in the package to connect Oscar to the USB port of a computer which is shown as below.



Figure 4.22 Connect Oscar to a computer

After completing the connection, the computer prompts a USB device, open it to view the files as below. Copy the folders and paste them to the computer.

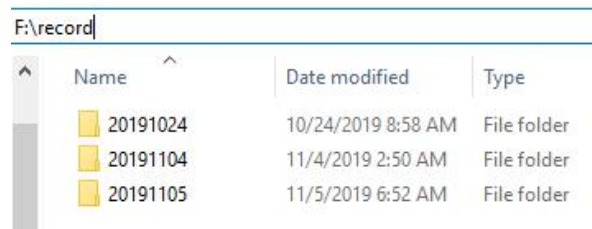

Figure 4.23 Static data recorded by Oscar

Note: When configuring static survey, if configure using buttons only, or configure using Nuwa with selecting None for Rinex format, Oscar only records trs format files. It is necessary to convert trs files to Rinex files before data post-processing.

Open Tersus Rinex Converter software, choose source file path, save path, source format, Rinex version, and click [Process] to complete the format conversion.

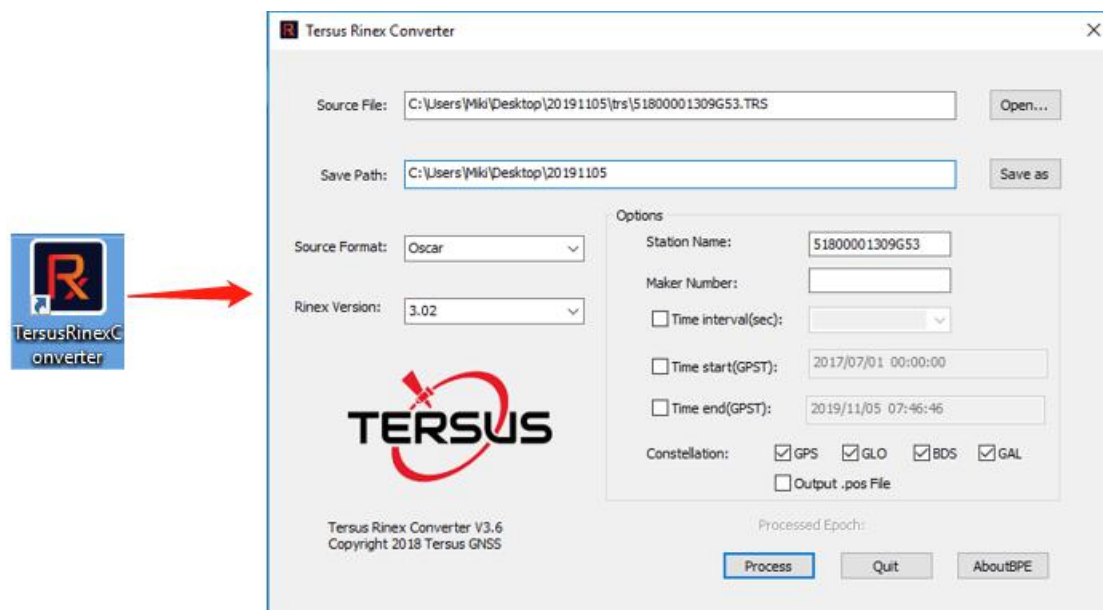

Figure 4.24 Tersus Rinex Converter interface

The Rinex files can be found in the save path as below.

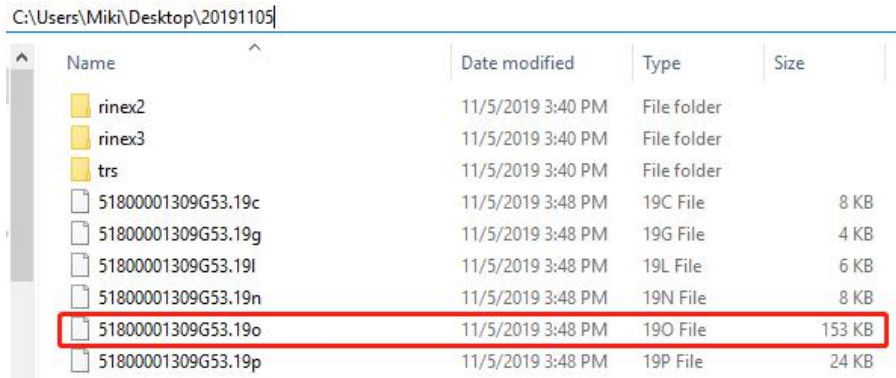

Figure 4.25 The Rinex files after conversion

4.4.3 Data post-processing

Open TERSUS Geo Office software:

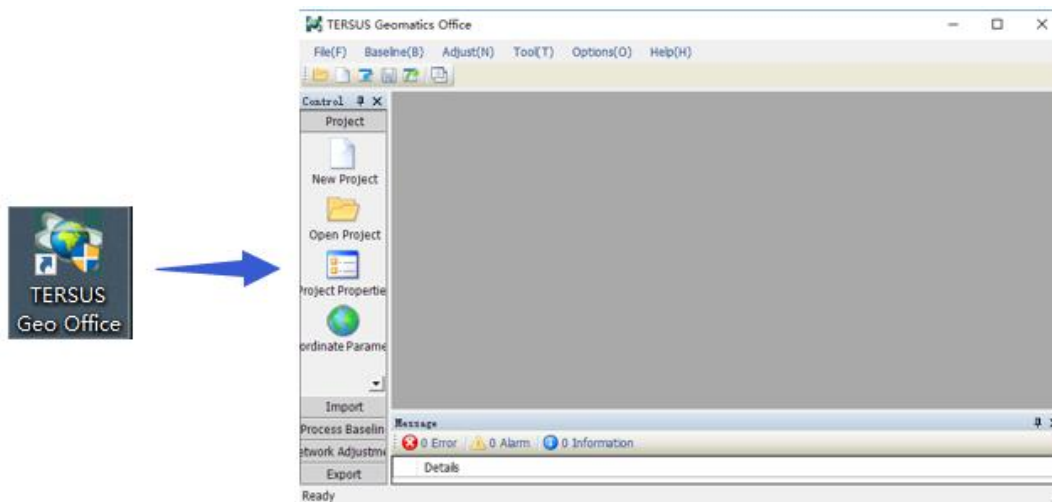

Figure 4.26 TERSUS Geomatics Office interface

After a project is created, click [Import] -> [Import Files]

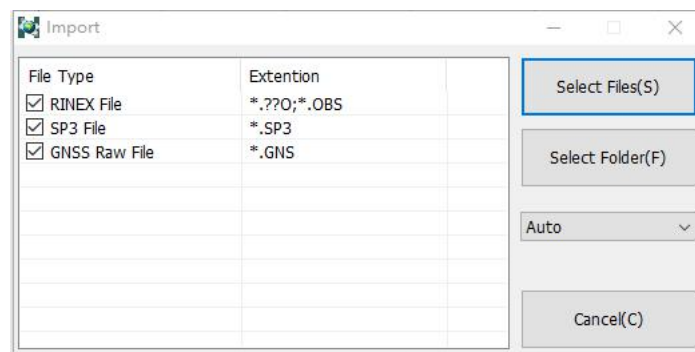
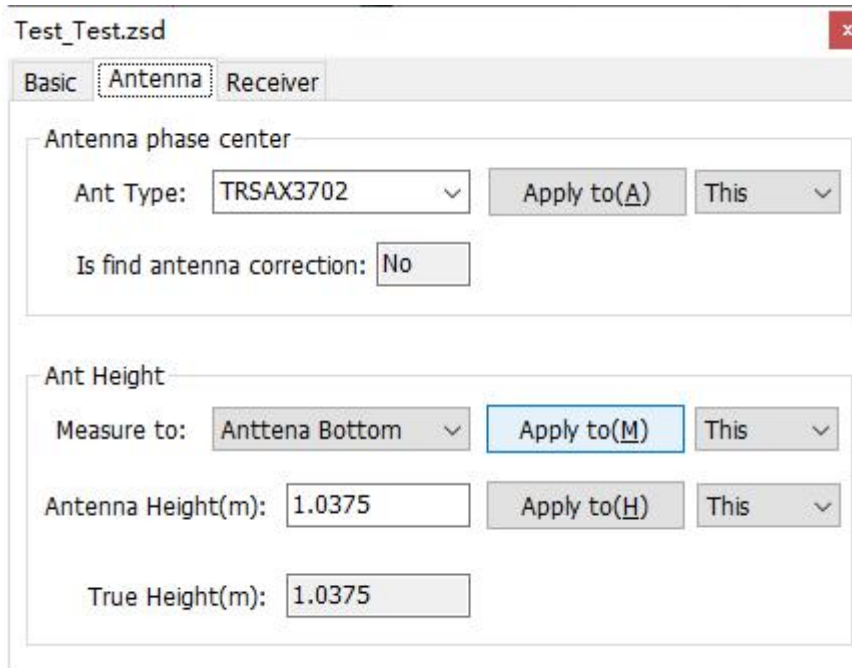

Figure 4.27 Import Files in TERSUS Geo Office

Click [Select Files] to load the Rinex files created in section 7.2.2.

After the above step of importing, the default configuration of the observation data is correct. There is no need to modify the configurations of antenna height, antenna type, and etc. The default configuration of the imported files is shown as follows.



The screenshot shows a configuration window titled "Test_Test.zsd" with three tabs: "Basic", "Antenna", and "Receiver". The "Antenna" tab is selected. The window is divided into two main sections: "Antenna phase center" and "Ant Height".

In the "Antenna phase center" section:

- "Ant Type" is set to "TRSAX3702".
- "Is find antenna correction" is set to "No".
- The "Apply to(A)" button is highlighted in blue.

In the "Ant Height" section:

- "Measure to" is set to "Antenna Bottom".
- "Antenna Height(m)" is set to "1.0375".
- "True Height(m)" is set to "1.0375".
- The "Apply to(M)" and "Apply to(H)" buttons are highlighted in blue.

Figure 4.28 Default configuration of the observation data

Refer to the user manual of Tersus Geo Office for more details on data post processing.

4.5 Point Correction

The point correction is to find the mathematical conversion relationship (transition parameter) between WGS84 and the local plane Cartesian coordinate system. There are three calculation types: four-parameter, height-fitting, and four-parameter + height-fitting.

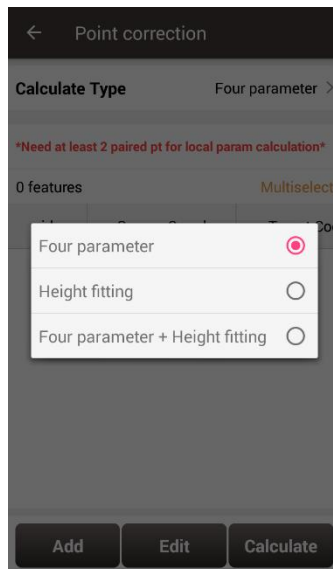

Figure 4.29 Calculation Type options

There are three methods for height-fitting: fixed difference correction, plane fitting and surface fitting.

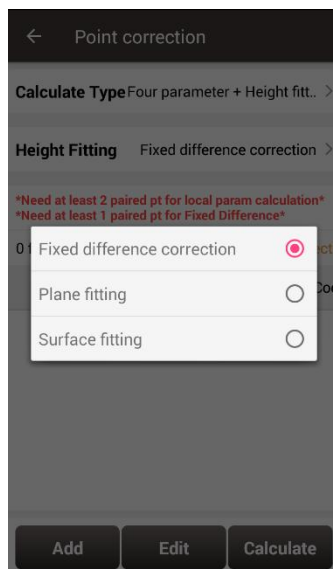

Figure 4.30 Height Fitting options

4.5.1 Four Parameter

At least two paired points are needed for Four Parameter type. Click [Add] to input the original coordinate values and the target coordinate values. Refer to section 2.4 about how to add points in the library.

4.5.2 Height Fitting

The number of points is different when different height fitting methods are used, the details are as follows:

Fixed Difference Correction: at least one paired point is needed.

Plane Fitting: at least three paired points are needed.

Surface Fitting: at least six paired points are needed.

Refer to section 2.4 about how to add points in the library.

4.5.3 Four Parameter + Height Fitting

The number of points is different when different height fitting methods are used, the details are as follows:

Fixed Difference Correction: at least two paired points for local parameter calculation and one paired point for fixed difference are needed.

Plane Fitting: at least two paired points for local parameter calculation and three paired points for plane fitting are needed.

Surface Fitting: at least two paired points for local parameter calculation and six paired points for surface fitting are needed.

Refer to section 2.4 about how to add points in the library.

4.5.4 Application Example

This section introduces an example of a calculation when Four Parameter + Height Fitting is selected for Calculate Type and Fixed Difference Correction is selected for Height

Fitting.

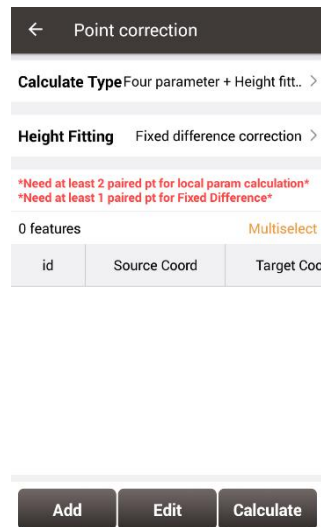

Figure 4.31 Application example for point correction

Click [Add] to add point for source coordinate and target coordinate.

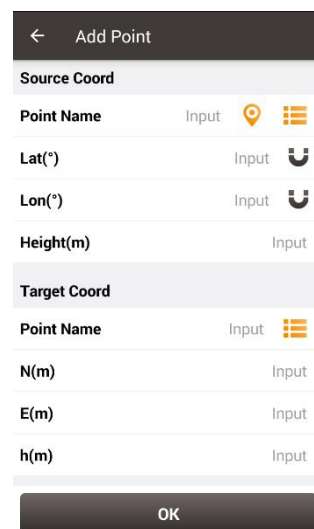

Figure 4.32 Add point for point correction

The source coordinate can be typed manually or obtained by clicking the location icon

or imported from the survey point library by clicking the list icon.

The target coordinate can be typed manually or imported from the control point library by

clicking the list icon.

In this example, two pairs of points are type manually for calculation, which are shown below.

Figure 4.33 The 1st pair of points for calculation

 Figure 4.34 The 2nd pair of points for calculation

Click [OK] and two pairs of points are shown below.

| id | Source Coord | Target Coord |
|----|---|---|
| 1 | B:31.198891390 L:120.716348150 H:3.9140 | N:3453071.6760 E:496716.0530 H:1.9740 |
| 2 | B:31.202320840 L:120.729190000 H:4.0250 | N:3453451.6210 E:497939.9990 H:2.0540 |

Figure 4.35 Two pairs of points for calculation

Click [Calculate] and the data is calculated with the result shown below.

← Result:

Local Para Result:

dDX(m) : 89.3786 dDY(m) : -7.7020

Rotation Angle : 3.1718797057

Scale : 0.9999680227

Height Fitting Result:

A0: 106.76839 A1: 0.00000

A2: 0.00000 A3: 0.00000

A4: 0.00000 A5: 0.00000

Max.HRMS 0.0000 NO.: 1

Max.VRMS 0.0154 NO.: 1

Cancel Apply

Figure 4.36 Calculation Result

Click [Apply] to apply the point correction result to the current project coordinate system, and it prompts that 'Apply result successfully!'.

← Point correction

Calculate Type Four parameter + Height fitt. >

Height Fitting Fixed difference correction >

Need at least 2 paired pt for local param calculation
Need at least 1 paired pt for Fixed Difference

2 features Multiselect

| id | Source Coord | Target Coord |
|----|---|---|
| 1 | B:31.198891390 L:120.716348150 H:3.9140 | N:3453071.6760 E:496716.0530 H:1.9740 |
| 2 | B:31.202320840 L:120.729190000 H:4.0250 | N:3453451.6210 E:497939.9990 H:2.0540 |

Apply result successfully!

Add Edit Calculate

Figure 4.37 Point correction results applied to current project

Slide left of the title bar to view the values of Residual results as shown below.

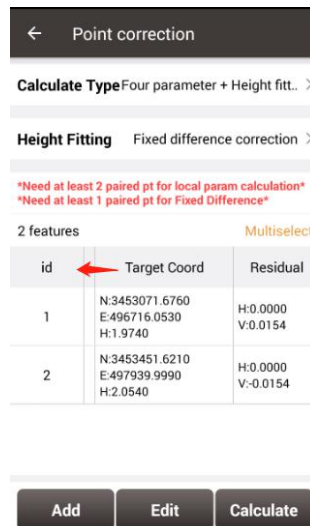

Figure 4.38 Slide left to view residual results

The results applied to the current project coordinate system can be checked in Project Property interface below.

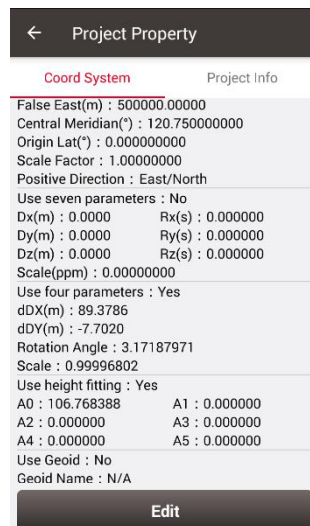

Figure 4.39 Updated project property after point correction

4.6 Survey Config

During data collection, restrictions are given to solution type and HRMS limits, hence only the data meeting the restrictions can be saved. More details are as follows:

4.6.1 Common Config

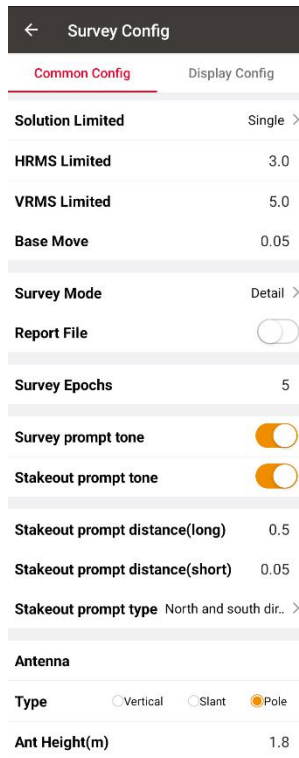

Figure 4.40 Survey Config - Detail

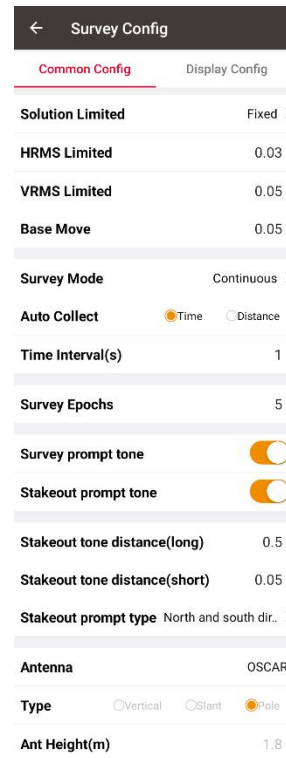

Figure 4.41 Survey Config – Continuous

[Solution Limited]: includes Single, DGPS, SBAS, Float and Fixed. The solution accuracy (from high to low) is: Fixed > Float > SBAS > DGPS > Single. Select different solution limits, the default HRMS, VRMS limit will change accordingly.

[HRMS Limited]: horizontal RMS limit. Data would not be collected if its HRMS is greater than this limit.

[VRMS Limited]: vertical RMS limit. Data would not be collected if its VRMS is greater than this limit.

[Base Move]: If the base moves over this limit, there will be a new base point and the rover coordinates will be recalculated according to the new base.

[Survey Mode]: can be selected from detail and continuous.

[Report File]: If Detail is selected, and turn on report file function, the coordinate of the survey epoch will be saved as a .txt file under project folder.

[Auto Collect]: if select continuous, data can be collected according to Time or Distance.

If Time is selected, ensure to input the time interval.

If Distance is selected, ensure to input the distance interval.

[Survey Epochs]: if select detail, the survey epoch can be modified. The survey epoch can be integer such as 2, 3, 5 or 10. Normally set to 5s.

[Survey Prompt Tone]: can be enable or disabled.

[Stakeout Prompt Tone]: can be enable or disabled.

[Stakeout tone distance(long)]: the distance threshold of the stakeout tone. For example, set 0.5 means the stakeout tone beeps every 2 seconds if distance is less than 0.5m.

[Stakeout tone distance(short)]: the distance threshold of the stakeout tone. For example, set 0.05 means the stakeout tone beeps every 1 seconds if distance is less than 0.05m.

[Stakeout Prompt Type]: can be North and South direction or Forward and Backward.

[Antenna]: Antenna name.

[Type]: height type, can be vertical, slant or pole.

[Ant Height]: value of the antenna height according the specified measuring type.

4.6.2 Display Config

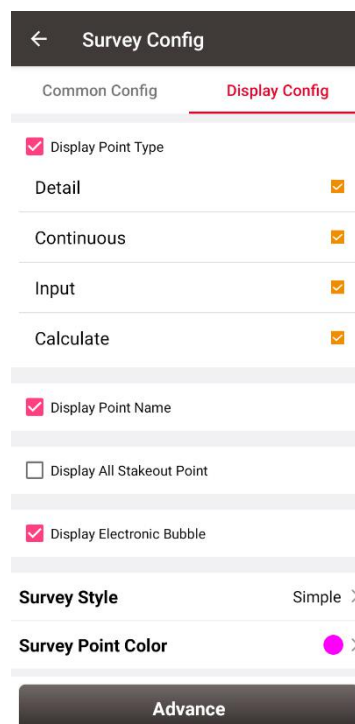

Figure 4.42 Survey Config – Display Config

Select the Display Point Type, Display Point Name, Display all stakeout point or Display Electronic Bubble according to the application requirement.

Select Survey Style: Simple or Detailed.



Figure 4.43 Survey Point Color

Click [Survey Point Colour] to select a colour on the outer ring for the survey points and click the inner pie to confirm the colour.

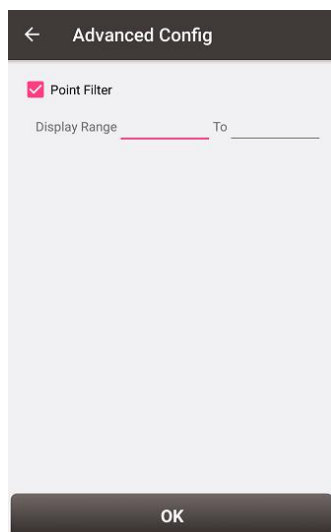

Figure 4.44 Advanced Config for Display Config

Click [Advance] to filter the displayed points.

4.7 Base Shift

In 'Auto Start' mode for base station, if the base is moved, re-erected or restarted at an unknown point, base shift should be performed to ensure the points collected by the current base station is consistent with that before the base is moved or powered off.

Briefly, find a known point, measure the coordinates of this point, then use this point to calculate the offset of the base shift, apply the base shift to all the survey points under the current base coordinates to make the reference coordinate system of the base remains the same as the previous base station.

The detailed steps are as follows:

Click [Base Shift] to enter the following interface, Figure 4.45 shows the calculation result for the base shift; Figure 4.46 shows the source of the base shift calculation. Click the list icon on the right of GNSS Point to select a survey point which is measured at the known point and click the list icon on the right of Known Point to select a known point in the control point library (details of control point refers to section 2.4 Point). Click [Calculate] and the base shift is calculated automatically. Click [Apply] to apply the base shift to all the points surveyed and to be surveyed under the current base station.

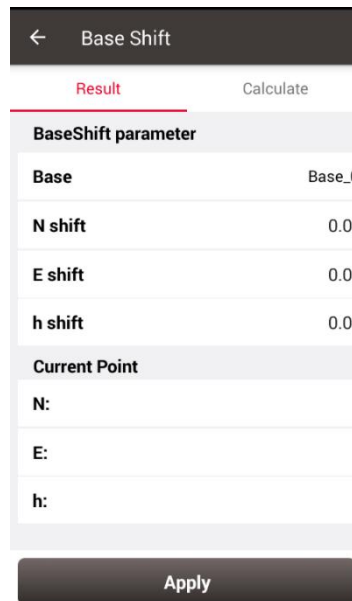

| BaseShift parameter | |
|---------------------|--------|
| Base | Base_0 |
| N shift | 0.0 |
| E shift | 0.0 |
| h shift | 0.0 |

| Current Point | |
|---------------|--|
| N: | |
| E: | |
| h: | |

Figure 4.45 Base Shift interface – 1

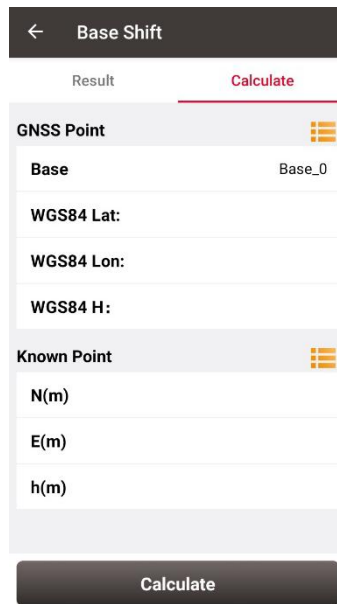

Figure 4.46 Base Shift interface – 2

At this time, select the base point in the survey point library to view the details. It can be found that the current NEh shift amount is recorded in the base point information, and the NEh coordinates of all the survey points under this base station change accordingly.

If you need to reset (cancel) the base shift, just enter [base shift], and manually modify the three parameters of north shift, east shift and height shift to 0. At this time, return to the survey point library to view the details of the base point. The NEh shift amount in the base point information is automatically changed to 0, and all survey points NEh coordinates under the base station are restored to the coordinates before the base shift.

5. Tools

- Area Perimeter
- Azimuth Distance
- Offset Point
- Rotation Point
- Two Points Intersection
- Four Points Intersection
- Intersection Angle

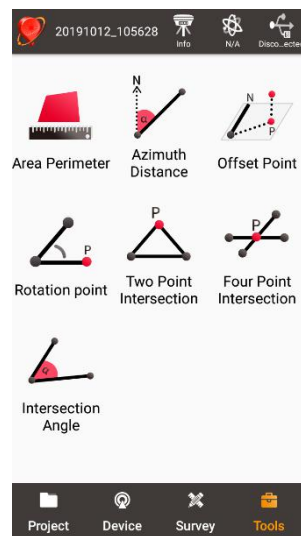

Figure 5.1 Functions under Tools

5.1 Area Perimeter

This tool is used to calculate area and perimeter. The points can be imported from the point library by clicking the list icon on the upper right corner. The unit is meter for perimeter and square meter for area.



Figure 5.2 Area Perimeter interface

[Graphic]: shows the closed polygon formed by the points.

[Calculate]: calculates the area and perimeter of the closed polygon.

[Multiselect]: enters point edit interface to inverse or delete.

Note: The calculation results are all plane results (point elevation does not participate in the calculation). It is suitable for all sections in this chapter except section 5.3 Offset Point.

5.2 Azimuth Distance

There are two kinds of azimuth distance calculation: point to point, and point to line. The points can be imported from the point library.

5.2.1 Point to Point Distance

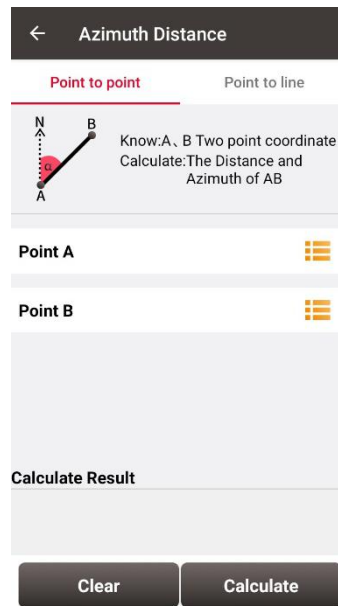

Figure 5.3 Azimuth Distance – Point to Point

Import point A and point B from the point library.

[Calculate]: calculate the distance between the two points and the azimuth.

[Clear]: clear the result.

5.2.2 Point to Line Distance

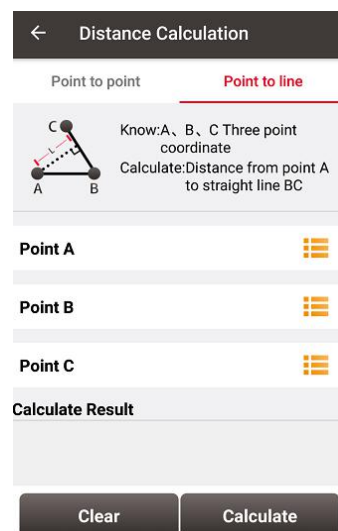

Figure 5.4 Azimuth Distance – Point to Line

Import points from the library to calculate the distance from point A to line BC.

[Calculate]: calculate the distance.

[Clear]: clear the result.

5.3 Offset Point

Given the azimuth of point A & P, AP's horizontal length L and height H, calculate the coordinate of P. The steps are as follows:

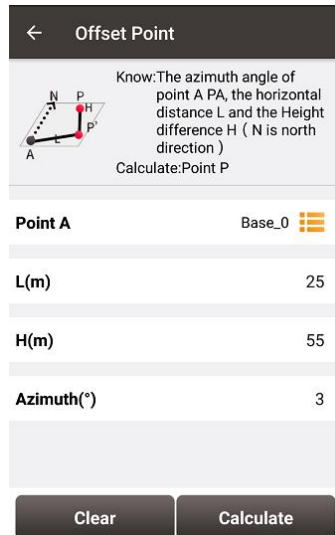

← Offset Point

Know: The azimuth angle of point A PA, the horizontal distance L and the Height difference H (N is north direction)
Calculate: Point P

Point A Base_0

L(m) 25

H(m) 55

Azimuth(°) 3

Clear Calculate

Figure 5.5 Offset Point interface

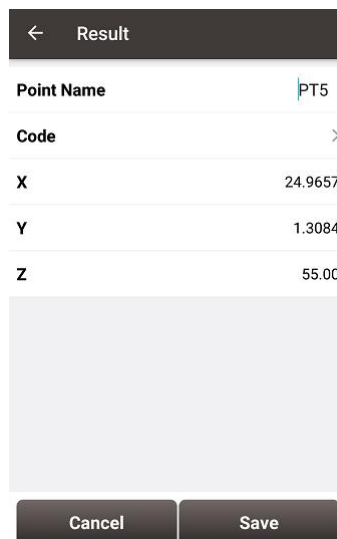

← Result

Point Name PT5

Code >

X 24.9657

Y 1.3084

Z 55.00

Cancel Save

Figure 5.6 Offset Point calculation result

[Calculate]: calculate the coordinate of point P.

[Clear]: clear the current result.

5.4 Rotation Point

Given the coordinates of point A, B and the rotation angle (clockwise), calculate the coordinate of point B after rotation.

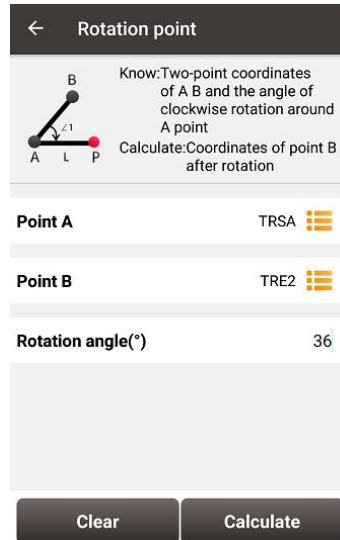

← Rotation point

Know: Two-point coordinates of A B and the angle of clockwise rotation around A point
Calculate: Coordinates of point B after rotation

Point A TRSA

Point B TRE2

Rotation angle(°) 36

Clear Calculate

Figure 5.7 Rotation Point interface

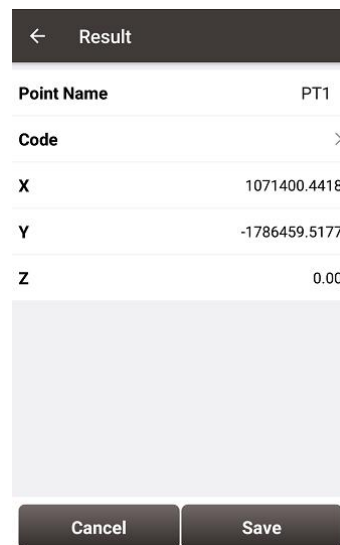

← Result

Point Name PT1

Code >

X 1071400.4418

Y -1786459.5177

Z 0.00

Cancel Save

Figure 5.8 Rotation Point Calculation result

[Calculate]: calculate the coordinate of point B after rotation.

[Clear]: clear the result.

5.5 Two Points Intersection

There are two types of models listed below:

- Model 1: Given the coordinates of point A and B, the angle α between line AB and AP, the angle β between line AB and PB, calculate the coordinate of point P.
- Model 2: Given the coordinates of point A and B, the length of line AP and BP, calculate the coordinate of point P.

Figure 5.9 Two Point Intersection – Angle

Figure 5.10 Two Point Intersection – Distance

[Calculate]: calculate the coordinate of the intersection P.

[Clear]: clear the result.

5.6 Four Points Intersection

Given the coordinates of point A, B, C and D, calculate the coordinate of the intersection point P between line AB and line CD.

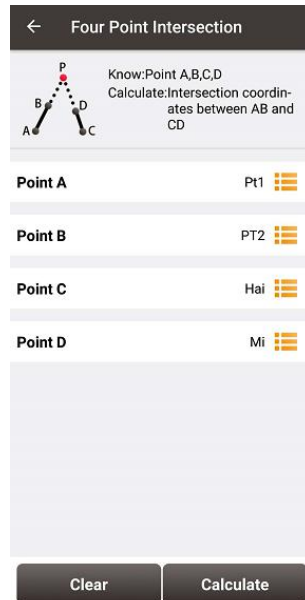

Figure 5.11 Four Point Intersection interface

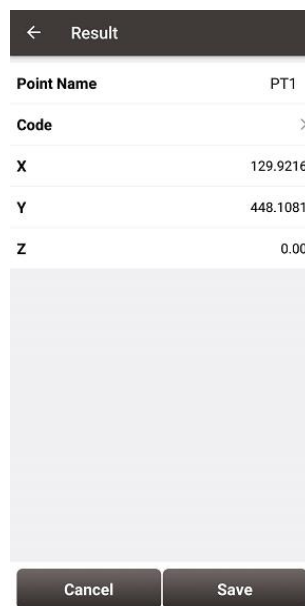

Figure 5.12 Four Point Intersection result

[Calculate]: calculate the coordinate of the intersection P.

[Clear]: clear the result.

5.7 Intersection Angle

Given the coordinates of point A, B and C, calculate the angle $\angle ABC$



Figure 5.13 Intersection Angle calculation

[Calculate]: calculate the angle $\angle ABC$.

[Clear]: clear the result.

6. TC20 Controller and application

6.1 Overview of TC20 Controller

The Tersus TC20 Controller is a rugged smart phone with design of 4.3" touch screen and an alphanumerical keypad. Equipped with powerful processor, it is perfect to adapt with Tersus Survey software. With professional IP67 rating, it is robust and reliable for harsh operating conditions.

Features:

- Rugged smart phone 4.3" display
- 4G GSM unlocked Android 6.0
- Quad-Core 1.3GHz CPU
- 2GB RAM + 16GB ROM
- 8 MP Auto Focus camera
- IP67 certified grade, water/shock/dust proof
- 6500 mAh battery
- A-GPS supported
- Wi-Fi, Bluetooth, NFC
- Two color options: red and yellow

Note: Although the TC20 controller uses chemical and impact resistant materials, precision instruments require careful use and maintenance and should be kept as dry as possible. In order to improve the stability and life cycle of the TC20 controller, avoid exposing the TC20 controller to extreme environments such as moisture, high temperatures, low temperatures, corrosive liquids or gases.



TC20 must be in the specified temperature range $-20^{\circ}\text{C} \sim 55^{\circ}\text{C}$ when used and stored.

6.2 Outlook of TC20 Controller

Power on: Press and hold the power button for 3 seconds

Power off: Press and hold the power button for 3 seconds, select 'power off' in the menu option.



Figure 6.1 Four sides of TC20 controller

Menu Key: Select to show the available menu in current screen.

Home Key: Return to home screen. To view recent application, press and hold the home key.

Back Key: Return to previous screen.

Volume Key: Adjust the volume of the ringtone.

Reset Key: Shut down the phone when the device is abnormal.

Camera key: Short press to enter camera in home screen. Long press it to open torch.

6.3 Accessories of TC20 Controller

TC20 Lithium Battery (3.7V/6500mAh)



Figure 6.2 TC20 Lithium battery

TC20 Charger Adapter (5V/1A) with one USB port



Figure 6.3 TC20 Charger Adapter



Figure 6.4 TC20 Charger Adapter Plugs

A: American, B: British, C: Chinese, E: European, N: Australian

Put the plug in in the back of the adapter to assemble the TC20 Charger.

The hand strap below is for easy handling of TC20 controller.



Figure 6.5 TC20 Controller hand strap

The stylus pen below is for easy touch of screen on TC20 controller.



Figure 6.6 Stylus Pen for TC20

The mini USB cable below is to charge TC20 controller or transfer files between TC20 controller and a computer.



Figure 6.7 Mini USB cable

6.4 General Operations

6.4.1 Insert SIM card and Micro SD card

1. **Remove the back cover:** Loosen the screws on the back side - to rotate the screws anti-clockwise until open the back cover as shown in Figure 6.8.



Figure 6.8 Remove the back cover

2. **Take off the back cover:** Remove the back cover by lifting it up from the bottom part as shown in Figure 6.9 and take out the battery.



Figure 6.9 Take off the back cover

3. **Put the SIM Card in the holder:** Put the SIM card into the slot touching the SIM contacts of the phone as shown in Figure 6.10.



Figure 6.10 Put the SIM card in the holder

4. **Insert Micro SD card:** Open Micro SD card holder and insert Micro SD card into the slot, then close Micro SD card holder as shown in Figure 6.11.



Figure 6.11 Insert Micro SD card

5. **Insert the back cover:** Insert the back cover and rotate screws clockwise to lock the back cover as shown in Figure 6.12.



Figure 6.12 Insert the back cover

Note: Please power off the phone before plug in or pull out the SIM card.

6.4.2 Micro SD card

1. Connect USB, turn on USB storage.

It automatically pops up USB connected interface after connecting USB, and then click [Transfer Files] to turn on USB storage to use the files in the Micro-SD card.

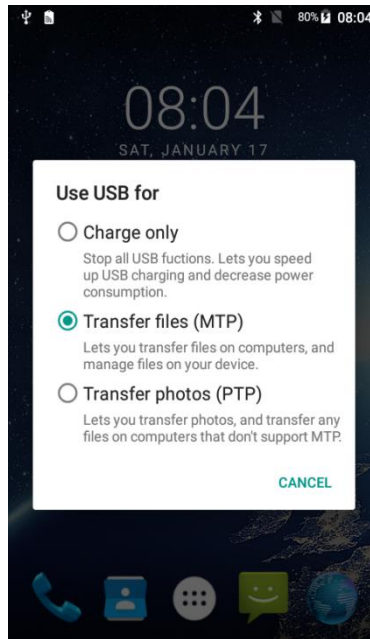

Figure 6.13 Select USB function

6.4.3 Using of Touch Screen

Single Click: To select an icon. For example, click dial to open the keypad which will be displayed on the screen.

Double Click: To zoom-in or zoom-out. For example, to zoom-in or out of a photo, click twice when viewing a photo or browsing on the internet.

Hold: Click and hold the screen, icon or input box to get more operation options.

- 1) Long-Time Click a picture in the gallery list interface, the status bar prompts to select a picture, you select to share or delete.
- 2) Long-Time Click the blanks of home screen to add home screen shortcut.
- 3) Long-Time Click the blanks of home screen wallpaper sources can be selected.

Drag the screen: You can drag the screen to view more applications which are not displayed in one screen.

7. Technical Appendix

7.1 Quick Start

1. Create a new project

Go to [Project] -> [Project], click [New], input the project name, select a CRS or edit with a template CRS, click [OK] to create a project.

2. Connect a device

Go to [Device] -> [Connect], select the device type, connect type, connect config and antenna type, and click [Connect]. Click  in the status bar can also connect to the device.

3. Configure the base and the rover

A base transmits RTK corrections to a radio or to network. The position of the base must be input manually or auto start. Nuwa supports RTK uploading to a NTRIP host, which brings convenience for a number of applications.

A rover receives RTK corrections from a radio or from network. NTRIP, TCP and TCS protocols are supported if corrections are received from network.

All the configuration can be managed, such as created, edited and deleted in Nuwa App. A device can be configured to work as a base or as a rover.

4. Point Correction and Base Shift

The point correction is to find the mathematical conversion relationship (transition parameter) between WGS84 and the local plane Cartesian coordinate system. There are three calculation types: four-parameter, height-fitting, and four-parameter + height-fitting.

There are three methods for height fitting: Fixed Difference Correction, Plane Fitting and Surface Fitting.

In Auto Start mode, if a base is moved, re-installed or powered off, Base Shift is necessary to make the points have the same coordinates before and after the change. Main steps: Go to [Survey] -> [Base Shift], select GNSS points and known points, click [Calculate], the offsets parameters are calculated automatically. The user can apply the parameters on the points to be surveyed. Base Shift also influence coordinates value of other points with this base.

Steps 5 – 8 are action points in fields, select one or more in fields.

5. Survey

Go to [Survey] -> [Survey] to enter survey interface, which can be in text mode or drawing mode. The main difference between the two modes is whether the drawing is displayed.

The configuration refers to section 4.6.1 Common Config for more details.

Two collection modes: Auto Collect and Manual Collect, refer to section 4.1 Survey for details. All the detailed information about the survey points can be checked in the survey point library.

6. Point Stakeout

Go to [Survey] -> [Point Stakeout] to enter point stakeout interface. Stakeout points must be saved in the stakeout point library before. Select the points to be stakeout and find the target point according to the prompt information by Nuwa, refer to section 4.2 Point Stakeout for details.

7. Line Stakeout

Go to [Survey] -> [Line Stakeout] to enter line stakeout interface. Stakeout lines must be saved in the stakeout line library. Select the lines to be stakeout and find all the points on the target line according to the prompt information by Nuwa, refer to section 4.3 Line Stakeout for details.

8. Static Survey

Go to [Survey] -> [Static Survey] to enter static survey interface. Select the parameters, such as interval, cut off angle, antenna parameters and click [Start], refer to section 0

Static Survey for details.

9. Export

Go to [Project] -> [Export] to enter export interface. The supporting file formats include: csv, kml, shp, dxf, html and kml. The data to be exported can be filtered by point type and collection time. Click [Export] after all the options are filled.

10. Import

Go to [Project] -> [Import] to enter import interface, which can be divided into Coordinate Import and Other Import.

Coordinate import is to import points in a .csv file or .dat file, mainly to import points to a library.

Other import is to import the DXF or SHP files for the background. Click [File Path] to select the file directory.

7.2 Issues and Solutions

1. Bluetooth / USB cannot be connected with David.

- (1) Check if other devices have connected to Bluetooth (COMM1-Bluetooth module only supports Android phones);
- (2) Check if the Bluetooth model matches the David GNSS receiver, the David-R model matches the BT420R model of Bluetooth module, and the David model matches the BT420A model of Bluetooth module;
- (3) Check if the David GNSS receiver is powered on normally. If the receiver's LED is bright but cannot search for the Bluetooth name, please delete the matched Bluetooth in the phone and search again. If you still cannot find the Bluetooth device name, please contact the supplier for assistance;
- (4) Reconnect USB and allow USB device to connect when USB cannot be connected;
- (5) If the radio base station mode is used, check the power supply. At this time, only the 12V battery can be used for power supply. Do not use 5V power bank for power supply.

2. David GNSS receiver cannot be located.

- (1) Check if the GNSS antenna is properly connected;
- (2) Check if the GNSS antenna cable and connector are intact or damaged.
- (3) Ensure that the GNSS antenna is placed in an open outdoor environment;
- (4) Check if David's LED light is in normal startup state.

3. The rover with 2W radio kit cannot obtain a fixed solution.

- (1) Check if the radio 'T/R' LED is in the receiving state with blue light. If it is not in the receiving state, press and hold the 'CHAN' and 'PWR' buttons for about 1 second to switch to the receiving state.
- (2) Check whether the number of channels and the transmission protocol of the rover are consistent with that of the base radio;
- (3) Check whether the baud rate of the serial port of the 2W radio and the base radio is

normal. The baud rate of the serial port of the 2W radio and the 30W radio is 38400bps, and the baud rate of the serial port of the 1W radio is 115200bps.

4. The rover network mode cannot obtain a fixed solution.

- (1) Check if the network of the rover is normal, and whether the controller (an android device) can connect to the network normally;
- (2) Check if the rover's user name and password are correct, pay attention to case sensitivity, and there is no '@' character at the beginning of the rover's password;
- (3) Check if the rover's MountPoint is consistent with that of the base. It is recommended to use the default base serial number as MountPoint;
- (4) Check if the base has sent corrections data normally.

5. The base radio constantly restarts.

- (1) In the base radio mode, only 12V battery can be used for power supply, and 5V power bank cannot be used for power supply;
- (2) Check if the battery is low power or insufficient voltage.

6. The local coordinate deviation of the rover is large.

- (1) Check if the coordinate system of the project in Nuwa application is configured correctly;
- (2) If point correction or parameter calculation is not performed, the base needs to be configured by manual start, and the known point coordinates of the base configuration should be consistent with the known point of the actual installation;
- (3) If point correction or parameter calculation is performed, check whether the coordinate of the control point is incorrectly entered, whether the coordinate deviation of the control point and the distribution of the control point is uniform, and whether the scale is close to 1 in the parameter calculation result.

7. It prompts that the coordinate deviation is large when configuring base.

- (1) If the input is WGS84 coordinates, check whether the input coordinates are the same

point, and the coordinate difference cannot be greater than 30m;

(2) If the input is local coordinates, check whether the configured coordinate system is consistent with the coordinates that need to be input.

8. The time for the rover to get a fixed solution is too long.

(1) Check the number of satellites for the rover, the satellite distribution (whether the occlusion is serious), and the satellite signal-to-noise ratio (whether the maximum signal-to-noise ratio is greater than 50);

(2) Check if the antenna connection is loose;

(3) Check whether the correction data of the base is normal, and whether it includes correction data of GPS, GLONASS, and BeiDou systems.

8. Terminology

| Abbreviation | Definition |
|---------------------|--|
| CRS | Coordinate System |
| GNSS | Global Navigation Satellite System |
| HDOP | Horizontal Dilution of Precision |
| HRMS | Horizontal Root Mean Square |
| OS | Operating System |
| PDA | Personal Digital Assistant |
| PDOP | Position Dilution of Precision |
| RINEX | Receiver Independent Exchange format |
| RMS | Root Mean Squares |
| RTCM | Radio Technical Commission for Maritime Services |
| RTK | Real-Time Kinematic |
| SNR | Signal Noise Ratio |
| UI | User Interface |
| UTC | Coordinated Universal Time |
| UTM Projection | Universal Transverse Mercator Projection |
| VDOP | Vertical Dilution of Precision |
| VRMS | Vertical Root Mean Square |

9. File Format

[.apk]: android app installation file

[.csd]: coordinate system file

[.csv]: excel file

[.dat]: data file

[.dxf]: CAD data file developed by Autodesk

[.ggf]: Geoid file

[.kml]: landmark file developed by Google

[.lnb]: line file

[.shp]: shape file developed by ESRI

[.txt]: text file

Proprietary Notice

All Information in this document is subject to change without notice and does not reflect the commitment on Tersus GNSS Inc. No part of this manual may be reproduced or transmitted by all means without authorization of Tersus GNSS Inc. The software described in this document must be used in terms of the agreement. Any modification without permission from Tersus GNSS Inc. is not allowed.