

User Manual

Version V1.1-20190321



User Manual

For Tersus GeoBee

Cost-effective Solution for Ntrip Corrections

©2019 Tersus GNSS Inc. All rights reserved.



Sales & Technical Support:

sales@tersus-gnss.com & support@tersus-gnss.com

More details, please visit www.tersus-gnss.com

Revision History

Version	Revision Date	Change Summary
1.0	20190121	Initial Release
1.1	20190321	Update cover photo; Update section 2.1.2 Configure David; Add section 2.5 Observation Data Storage and 4.3 Check Link Status using Web Portal

Table of Content

Revision History.....	1
Table of Content.....	2
List of Figures.....	4
List of Tables.....	5
1. Introduction.....	6
1.1 Overview.....	6
1.2 System Structure.....	7
1.3 Devices in GeoBee Package.....	10
1.3.1 David GNSS Receiver.....	10
1.3.2 AX3702 GNSS Antenna.....	11
1.3.3 TR600 Ntrip Modem.....	12
1.3.4 Other accessories.....	13
1.4 Installation Guide.....	17
1.4.1 Install bottom plate for fixing David.....	17
1.4.2 Install bracket and slide rail for TR600.....	18
2. General Operation.....	19
2.1 Configurations.....	19
2.1.1 Accessories Required.....	19
2.1.2 Configure David.....	19
2.1.3 Configure TR600.....	22
2.2 Configuration Parameters.....	26
2.3 Factory Reset.....	27
2.4 Firmware Upgrade.....	27
2.5 Observation Data Storage.....	29
3. Specifications.....	32
3.1 David GNSS Receiver.....	32

3.2	AX3702 GNSS Antenna.....	35
3.3	TR600 Ntrip Modem.....	36
4.	Typical Application.....	38
4.1	GeoBee working under Ntrip server mode.....	38
4.2	GeoBee working under Ntrip client mode.....	39
4.3	Check Link Status using Web portal.....	40
5.	Terminology.....	41

List of Figures

Figure 1.1 GeoBee System Structure.....	7
Figure 1.2 David GNSS Receiver.....	10
Figure 1.3 AX3702 GNSS Antenna.....	11
Figure 1.4 TNC-J to SMA Cable (GNSS antenna cable, 25m by default)	11
Figure 1.5 TR600 side view 1.....	12
Figure 1.6 TR600 side view 2.....	12
Figure 1.7 COMM1-Bluetooth Module.....	13
Figure 1.8 DC-2pin AC Power Adapter with 1.2m cable.....	13
Figure 1.9 COMM2-7pin to TR600-DC-2pin & DB9 female cable.....	14
Figure 1.10 COMM1-7pin to USB & DB9 male Cable.....	14
Figure 1.11 RS232 to RS485 converter.....	15
Figure 1.12 DB9 female to TR600-RS485-5pin cable.....	15
Figure 1.13 DB9 Female to USB Type A Male converter cable.....	15
Figure 1.14 USB Type A Female to USB (Micro +Type C) OTG cable....	15
Figure 1.15 4G antenna for TR600.....	16
Figure 1.16 Wi-Fi antenna for TR600.....	16
Figure 1.17 Ethernet cable 1.5m.....	16
Figure 1.18 Bottom plate for fixing David.....	17
Figure 1.19 Dimension of bottom plate.....	17
Figure 1.20 TR600 dimension.....	18
Figure 1.21 Bracket for TR600.....	18
Figure 1.22 Slide rail for TR600 (20cm).....	18
Figure 1.23 TR600 with bracket and slide rail.....	18
Figure 2.1 Configure David using Nuwa app.....	21
Figure 2.2 Properties for Internet Protocol (TCP/IP).....	22
Figure 2.3 Set IP address as 'Obtain an IP address automatically'.....	22
Figure 2.4 Login TR600 configuration interface.....	23

Figure 2.5 Check the current connection status.....	23
Figure 2.6 Select network in Network Settings.....	24
Figure 2.7 WiFi Client setting.....	24
Figure 2.8 Set Ntrip info in Ntrip configuration interface.....	25
Figure 2.9 Set Virhub configuration.....	26
Figure 2.10 Factory Reset for TR600.....	27
Figure 2.11 Update firmware for David.....	28
Figure 2.12 Update firmware for TR600.....	29
Figure 2.13 Launch STRSVR in RTKLIB.....	30
Figure 2.14 Input NTRIP Client information.....	30
Figure 2.15 Output information.....	30
Figure 2.16 Start saving observation data.....	31
Figure 3.1 Panel of David.....	34
Figure 3.2 Pin Definition of the COMM1/COMM2/DC ports.....	34
Figure 4.1 GeoBee under Ntrip server mode.....	38
Figure 4.2 GeoBee under Ntrip client mode.....	39

List of Tables

Table 1 Definition of LEDs.....	10
Table 2 David GNSS Performance.....	32
Table 3 Pin Definition of connectors on David.....	34
Table 4 AX3702 GNSS Antenna.....	35
Table 5 Ntrip Modem TR600 specifications.....	36

1. Introduction

This chapter mainly introduces the overview, system structure, package list, and installation guide of the Tersus GeoBee.

1.1 Overview

The Tersus GeoBee is a dedicated and cost-effective solution to transmit or receive Ntrip corrections. With Tersus Ntrip Caster Service, Ntrip Modem and David Receiver, the GeoBee opens the possibility for users to transmit Real Time Kinematic (RTK) corrections via Internet (Ethernet or 2G/3G/4G) in a simple, user-friendly way, just using a SIM card or Ethernet cable without any need of a static IP. GeoBee can also work as GNSS Rover to receive RTK corrections from Tersus Ntrip Caster or any CORS service.

Ntrip server mode: use David GNSS receiver to create a base station. This temporary base or CORS are for surveying, agriculture, UAV, machine control, and etc. It is also ideal for deformation monitoring. Tersus GNSS Inc. provides Ntrip Caster to transfer data.

Ntrip client mode: connect David or other Tersus GNSS receivers to Tersus Ntrip Caster or any Ntrip/CORS service. David is mainly used for surveying, and also used as a GNSS sensor in various applications, such as mobile mapping, UAV, machine control, agriculture, and etc.

1.2 System Structure

Set up the GeoBee system according to the figure below.

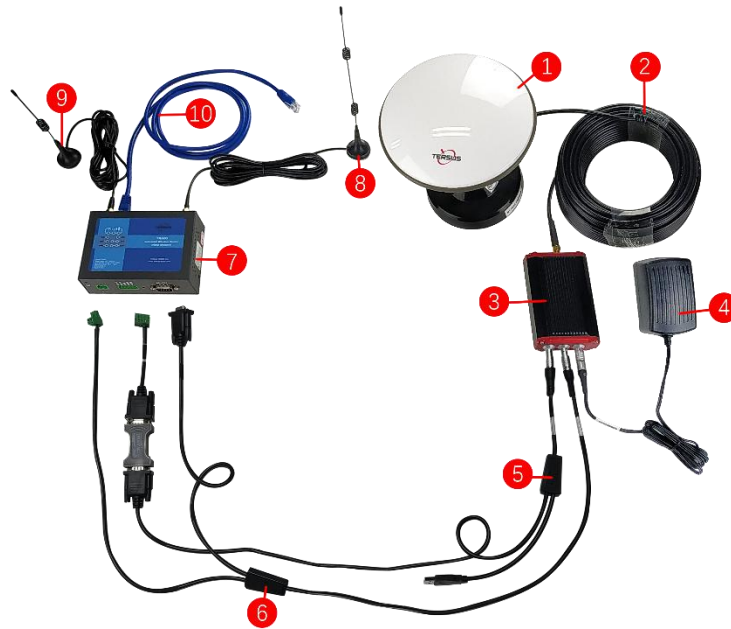

Figure 1.1 GeoBee System Structure

No.	Name
1	Antenna (AX3702 in the figure above, customizable)
2	TNC-J to SMA cable (25m by default, customizable)
3	David GNSS Receiver
4	Power Adapter (short for 'DC-2pin AC Power Adapter with 1.2m cable')
5	COMM1 cable (short for 'COMM1-7pin to USB & DB9 male cable')
6	COMM2 cable (short for 'COMM2-7pin to TR600-DC-2pin & DB9 female cable')
7	Ntrip Modem TR600
8	4G antenna for TR600
9	Wi-Fi antenna for TR600
10	Ethernet cable 1.5m

Note:

- 1) There are two configuration modes for GeoBee. GeoBee system is configure-free if customer adopts GeoCaster provided by Tersus GNSS Inc., as GeoBee is pre-configured when shipped out of factory. GeoBee system needs to be configured if customers demand to set up caster by themselves.
- 2) David GNSS receiver uploads RTCM stream to the NTRIP caster using Ethernet (default) or Wi-Fi or 2G/3G/4G sorted by priority. For Ntrip Modem TR600, Wi-Fi client and Wi-Fi hotspot are both supported, however they cannot be enabled simultaneously. Wi-Fi client function is to use Wi-Fi connection to communicate with caster. Wi-Fi hotspot function is to share internet connection to other devices.
- 3) Place the antenna (AX3702 in the Figure 1.1) in the outdoor open environment. Install Wi-Fi antenna when Wi-Fi connection is available for communication. Install 4G antenna when 2G/3G/4G SIM card is used for communication.
- 4) GeoBee starts to work in auto start mode by default once it is powered up. According to the autonomous positioning (without RTK or DGPS), it smooth out the average value to be the base coordinate. GeoBee outputs the RTCM32 corrections data and sends to the Ntrip caster through LAN, WIFI or 2G/3G/4G mobile network.
- 5) For the known phase center coordinates of the AX3702 antenna, the two configuration methods are as follows:
 - a. Use the 'DB9 Female to USB Type A Male converter cable' to connect the COMM1 cable in Figure 1.1 and a computer, open Tersus GNSS Center application on the computer, and type below commands in the command window:

```
POSAVE OFF           //Turn off position average
UNDULATION USER 0.0  //Set user specified undulation value for ellipsoid height1
FIX POSITION B L H     // B: latitude (degree), L: longitude (degree), H: height (m)
                    For example: FIX POSITION 31.24523012 121.58922341 40.35
SAVECONFIG           //save configuration
```

Note 1: If customer needs to use global geoidal height model EGM96 for mean sea level height, type below command to replace the undulation command above.

UNDULATION EGM96**//Set EGM96 geoidal height model**

More details about logs and commands refer to *Log & Command Reference* document.

- b. Use the COMM1-Bluetooth module in the package, insert the Bluetooth module to the COMM1 port of David GNSS receiver. Launch Nuwa app on an android device, connect David by pairing Bluetooth. Create a base configuration with manual start in radio mode, fill in the base coordinates and antenna height, and set Baud Rate as 115200 bps and Differential Format as RTCM3.2. Detailed operation refers to *User Manual for David GNSS Receiver*.
- 6) The known phase center coordinates of the AX3702 antenna can be obtained from surveying and mapping department of local government, or calculated from commercial software such as Bernese or Gamit.

1.3 Devices in GeoBee Package

1.3.1 David GNSS Receiver

David has four interfaces which is shown below.



Figure 1.2 David GNSS Receiver

The DC port of David is for power input, COMM1 port is for COM1 and CAN ports, and COMM2 port is for COM2 and USB ports, refer to section 3.1 for detailed specification of David.

Table 1 Definition of LEDs

LED	Colour	Description
PWR	RED	ON: the David is power on.
PV	BLUE	ON: David in Fixed solution. Blink: David in Float solution OFF: David in other position types.

1.3.2 AX3702 GNSS Antenna

AX3702 GNSS antenna is used to receive the RF signal from the satellites, and it must be connected to the David with the GNSS antenna cable in the package.



Figure 1.3 AX3702 GNSS Antenna



If an antenna from other companies is used, contact Tersus to obtain permission, or the David receiver may not work as expected.



Figure 1.4 TNC-J to SMA Cable (GNSS antenna cable, 25m by default)

1.3.3 TR600 Ntrip Modem



Figure 1.5 TR600 side view 1

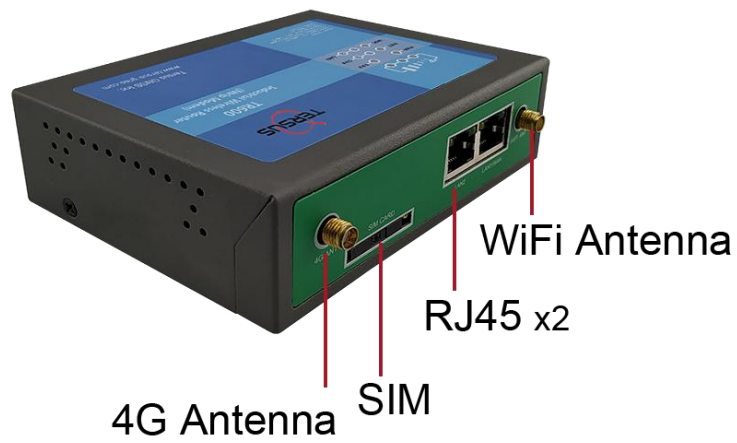

Figure 1.6 TR600 side view 2

1.3.4 Other accessories



Figure 1.7 COMM1-Bluetooth Module



The Bluetooth can only be installed to the COMM1 port of David.

This Bluetooth module is used to connect to the COMM1 port of David receiver.

The SSID of this Bluetooth module is BT420R-xxxxx_xxxxxx, where the first xxxxx is the last 5 digits of the Bluetooth serial number, which is printed on the Bluetooth module. No password is needed to pair with it.



Figure 1.8 DC-2pin AC Power Adapter with 1.2m cable

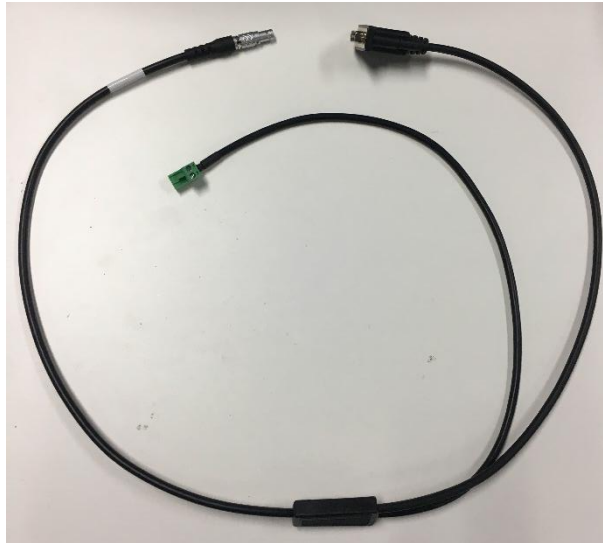

Figure 1.9 COMM2-7pin to TR600-DC-2pin & DB9 female cable



Figure 1.10 COMM1-7pin to USB & DB9 male Cable

!	The COMM1-7pin to USB & DB9 male cable can only be installed into the COMM1 port of David.
---	--

The COMM1-7pin to USB & DB9 male Cable has two functions:

- 1) Connect to DB9 female to USB Type A Male converter cable (refer to Figure 1.13) to download the file saved on the internal EMMC card, refer to section *Download Files from Internal EMMC Card* in David user manual;
- 2) Connect to USB Type A Female to USB (Micro +Type C) OTG cable (refer to Figure 1.14) to connect the Android phone or controller with David.



Figure 1.11 RS232 to RS485 converter



Figure 1.12 DB9 female to TR600-RS485-5pin cable



Figure 1.13 DB9 Female to USB Type A Male converter cable



Figure 1.14 USB Type A Female to USB (Micro +Type C) OTG cable



Figure 1.15 4G antenna for TR600



Figure 1.16 Wi-Fi antenna for TR600



Figure 1.17 Ethernet cable 1.5m

1.4 Installation Guide

1.4.1 Install bottom plate for fixing David

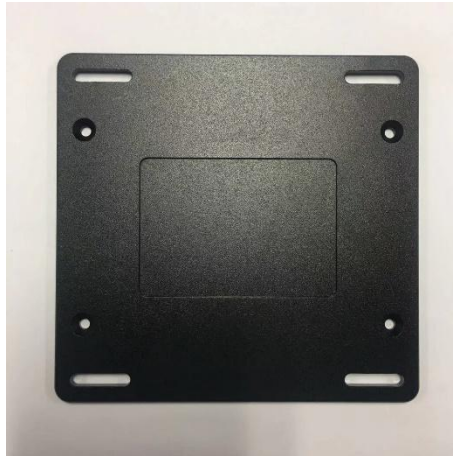

Figure 1.18 Bottom plate for fixing David

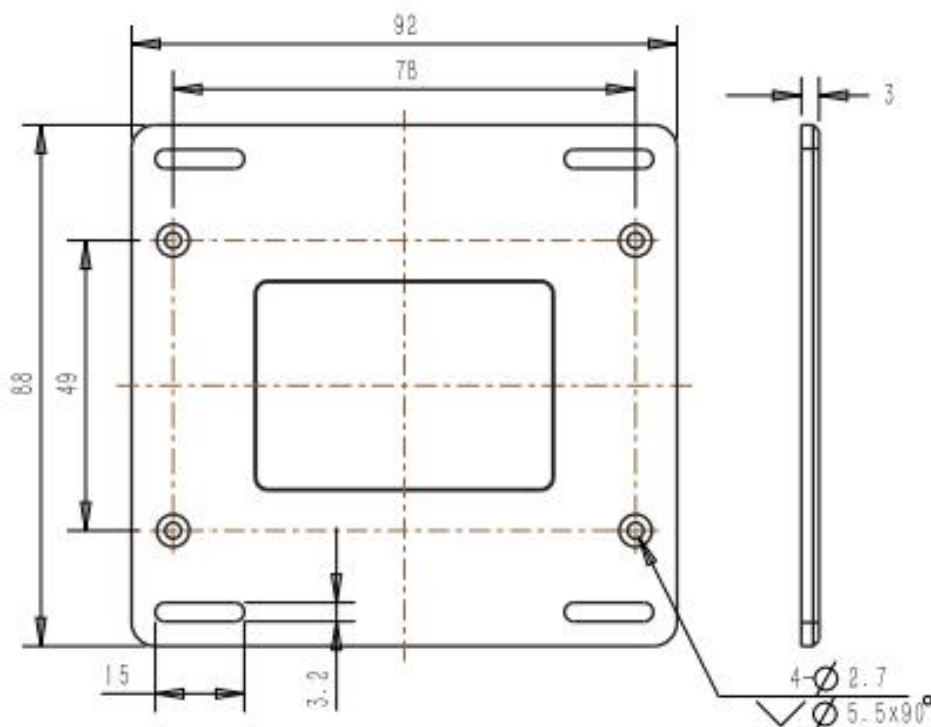

Figure 1.19 Dimension of bottom plate

Use the screws in the package to secure the bottom plate to the back of the David GNSS receiver. Hence it can be fixed to the places required.

1.4.2 Install bracket and slide rail for TR600

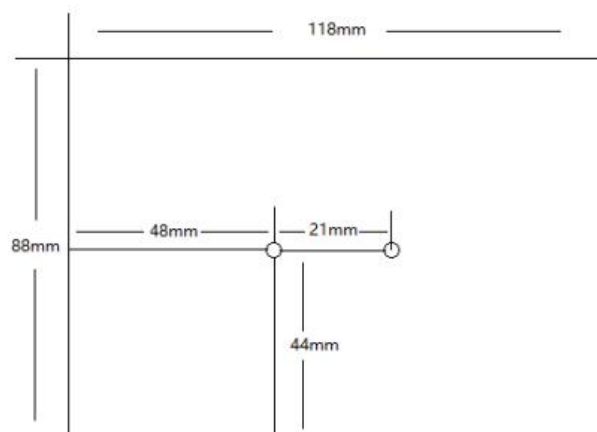

Figure 1.20 TR600 dimension



Figure 1.21 Bracket for TR600



Figure 1.22 Slide rail for TR600 (20cm)



Figure 1.23 TR600 with bracket and slide rail

Fix the bracket to the back of the TR600 with two screws, slide the rail into the bracket, and then use screws to fix the whole set to the places required.

2. General Operation

This chapter introduces how to use GeoBee, configuration parameters, factory reset and firmware upgrade.

2.1 Configurations

2.1.1 Accessories Required

The accessories required are listed below:

- 1) One Power Adapter (DC-2pin AC Power Adapter with 1.2m cable);
- 2) One COMM1 cable (COMM1-7pin to USB & DB9 male cable);
- 3) One DB9 Female to USB Type A Male Converter cable;
- 4) One COMM1-Bluetooth module;
- 5) One Ethernet cable for connecting TR600 and PC or customized device.

2.1.2 Configure David

Configuring David is able to be done using Tersus GNSS Center via cables or using Nuwa app via Bluetooth.

The detailed steps of configuring David using Tersus GNSS Center via cables are listed below:

- 1) Use the 'DB9 Female to USB Type A Male Converter cable' to connect the COMM1 cable (COMM1-7pin to USB & DB9 male cable) and a computer;
- 2) Open Tersus GNSS Center application on the computer and type below commands in the command window:

```
POSAVE OFF           //Turn off position average
UNDULATION USER 0.0 //Set user specified undulation value for ellipsoid height2
FIX POSITION B L H     //B: latitude (degree), L: longitude (degree), H: height (m)
                    For example: FIX POSITION 31.24523012 121.58922341 40.35
LOG COM2 RTCM1074 ONTIME 1 //output GPS RTK raw measurements
LOG COM2 RTCM1084 ONTIME 1 //output GLONASS raw measurements
LOG COM2 RTCM1124 ONTIME 1 //output BeiDou RTK raw measurements
LOG COM2 RTCM1005 ONTIME 10 //output the base's position
LOG COM2 RTCM1230 ONTIME 5 //output GLONASS bias information
SAVECONFIG           //save configuration
```

Note 2: If customer needs to use global geoidal height model EGM96 for mean sea level height, type below command to replace the undulation command above.

```
UNDULATION EGM96           //Set EGM96 geoidal height model
```

More details about logs and commands refer to *Log & Command Reference* document.

- 3) Power cycle the receiver or input RESET command to make the above configuration effective.

The detailed steps of configuring David via Bluetooth are listed below:

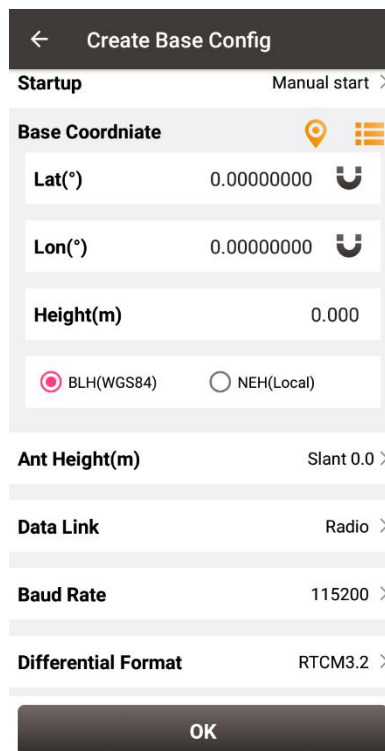

- 1) Insert the 'COMM1-Bluetooth module' into the COMM1 port of David GNSS receiver;
- 2) Connect the AX3702 GNSS antenna to David with the GNSS antenna cable;
- 3) Power on the David GNSS receiver by plugging the AC power adapter;
- 4) Run Nuwa app, click [Device] -> [Connect];

- 5) Select [Bluetooth] in the option list of Connect Type;
- 6) Click [Connect Config] -> [Search]. The SSID is BT420R-xxxxx_xxxxx. No password is needed to pair with it;
- 7) Click [Connect] to enable the communication with David;
- 8) After the Bluetooth module is connected with David successfully, configure David as a base with manual start in radio mode, fill in the base coordinates and antenna height, and set Baud Rate as 115200 bps and Differential Format as RTCM3.2. Detailed operation about David and Nuwa app refers to the *User Manual for David GNSS Receiver* and *User Manual for Nuwa app* which can be downloaded on Tersus website.



← Create Base Config

Startup Manual start >

Base Coordinate  

Lat(°) 0.00000000 

Lon(°) 0.00000000 

Height(m) 0.000

BLH(WGS84) NEH(Local)

Ant Height(m) Slant 0.0 >

Data Link Radio >

Baud Rate 115200 >

Differential Format RTCM3.2 >

OK

Figure 2.1 Configure David using Nuwa app

!	A Bluetooth device can be removed from the Available Device list by pressing it for a few seconds.
---	--

2.1.3 Configure TR600

The detailed steps of configuring TR600 are listed below:

- 1) Set IP address of the PC as 'Automatically obtain IP address';

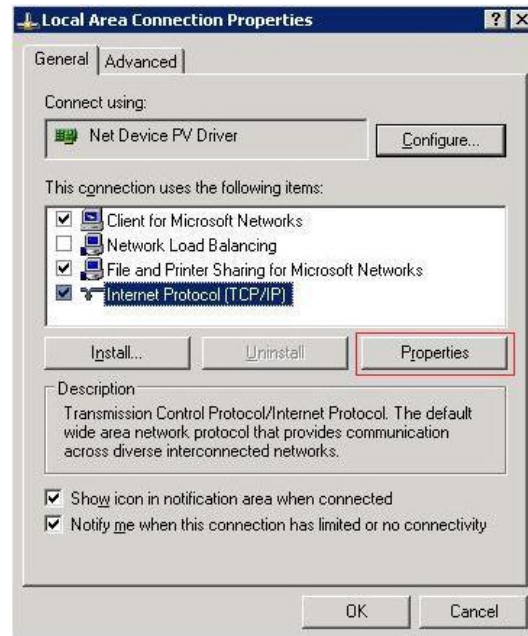

Figure 2.2 Properties for Internet Protocol (TCP/IP)

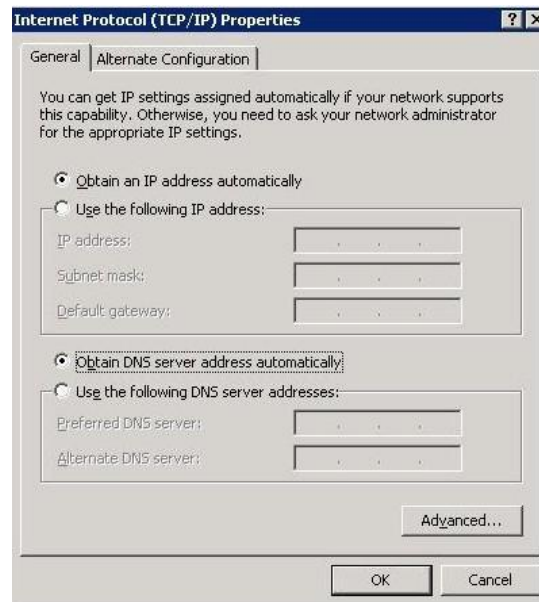

Figure 2.3 Set IP address as 'Obtain an IP address automatically'

- 2) Using Ethernet cable to connect the LAN2 port of TR600 to PC, connect the LAN1/WAN port to a router to access Internet;

- 3) Type in 192.168.100.1 or 192.168.1.1 in the browser of PC to enter the web configuration login page;
- 4) Type in username 'root' and password '1234' in the login page;





TR-600 	
用户名 (username):	<input type="text"/>
用户密码 (passwd):	<input type="password"/>
语言 (language):	ENGLISH ▾
<input type="button" value="登陆(login)"/>	

天硕导航

Figure 2.4 Login TR600 configuration interface

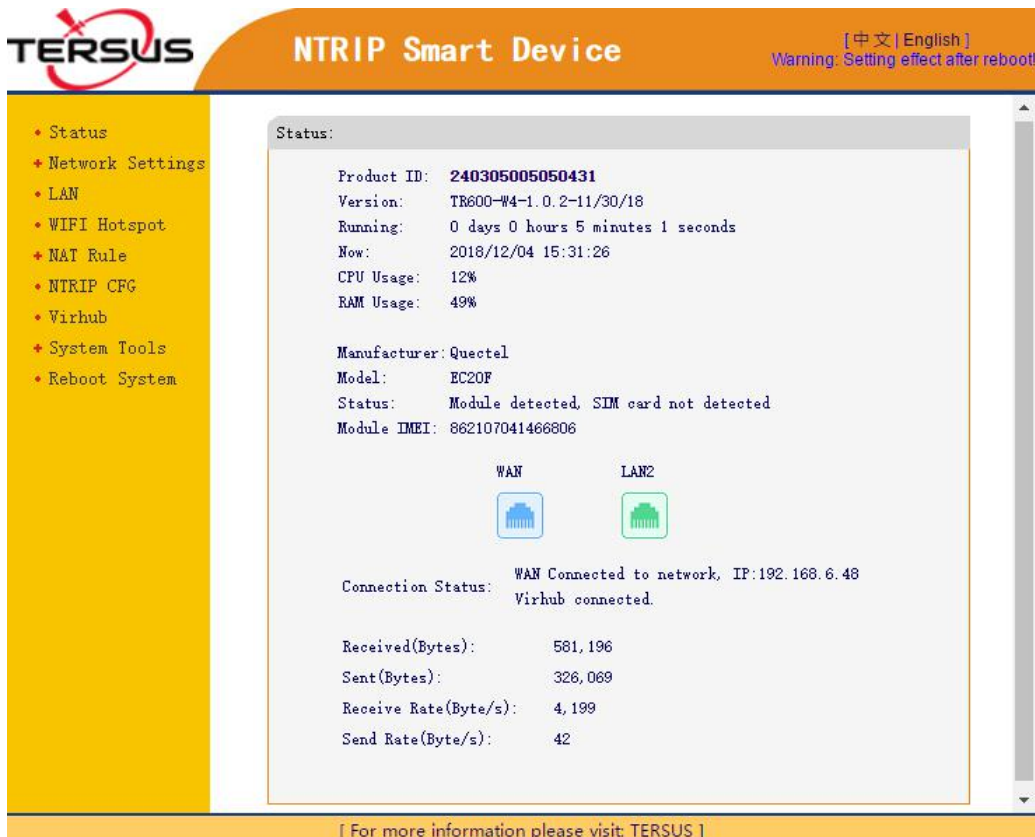
- 5) In the web configuration interface, check the current connection status.





NTRIP Smart Device

[中文 | English]
Warning: Setting effect after reboot

- Status
- Network Settings
- LAN
- WIFI Hotspot
- NAT Rule
- NTRIP CFG
- Virhub
- System Tools
- Reboot System

Status:

Product ID: **240305005050431**

Version: TR600-W4-1.0.2-11/30/18

Running: 0 days 0 hours 5 minutes 1 seconds

Now: 2018/12/04 15:31:26

CPU Usage: 12%

RAM Usage: 49%

Manufacturer: Quectel

Model: EC20F

Status: Module detected, SIM card not detected

Module IMEI: 862107041466806

WAN



LAN2



Connection Status: WAN Connected to network, IP:192.168.6.48
Virhub connected.

Received(Bytes): 581,196

Sent(Bytes): 326,069

Receive Rate(Byte/s): 4,199

Send Rate(Byte/s): 42

[For more information please visit: TERSUS]

Figure 2.5 Check the current connection status

- 6) Select 'WAN&WIFI&MOBILE' for Network option in Network Settings, and click [Save] to save this setting.

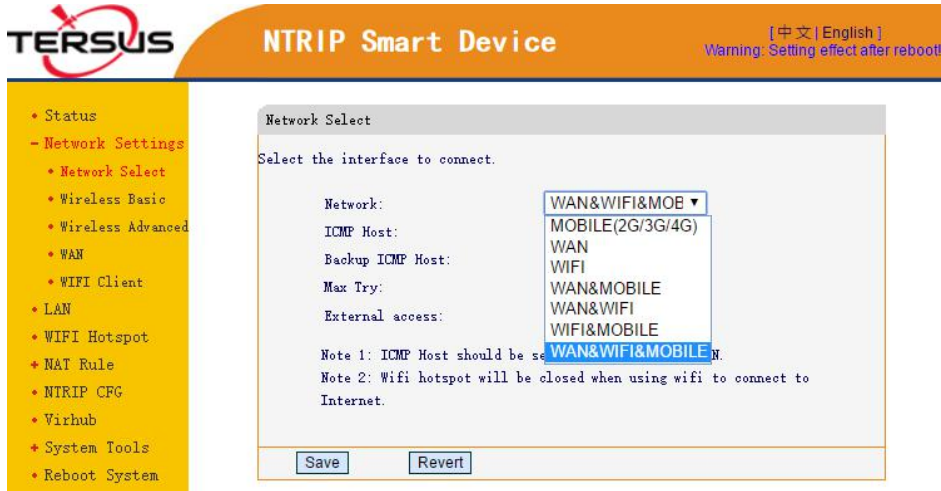

Figure 2.6 Select network in Network Settings

- 7) If WIFI Client is chosen to access internet, click WIFI Client in Network Settings, select a SSID to be used and type in the WIFI password in the PSK pin area, click [Save] to save this setting.



Figure 2.7 WiFi Client setting

- 8) Set corresponding NTRIP information in NTRIP configuration interface as shown in the upper red box according to the NTRIP information attached as a label on the Ntrip Modem TR600. The information for Data Center 1 in the lower red box is pre-configured as default if Tersus mserver is used. Contact Tersus Technical Support if users need other server for Data Center.

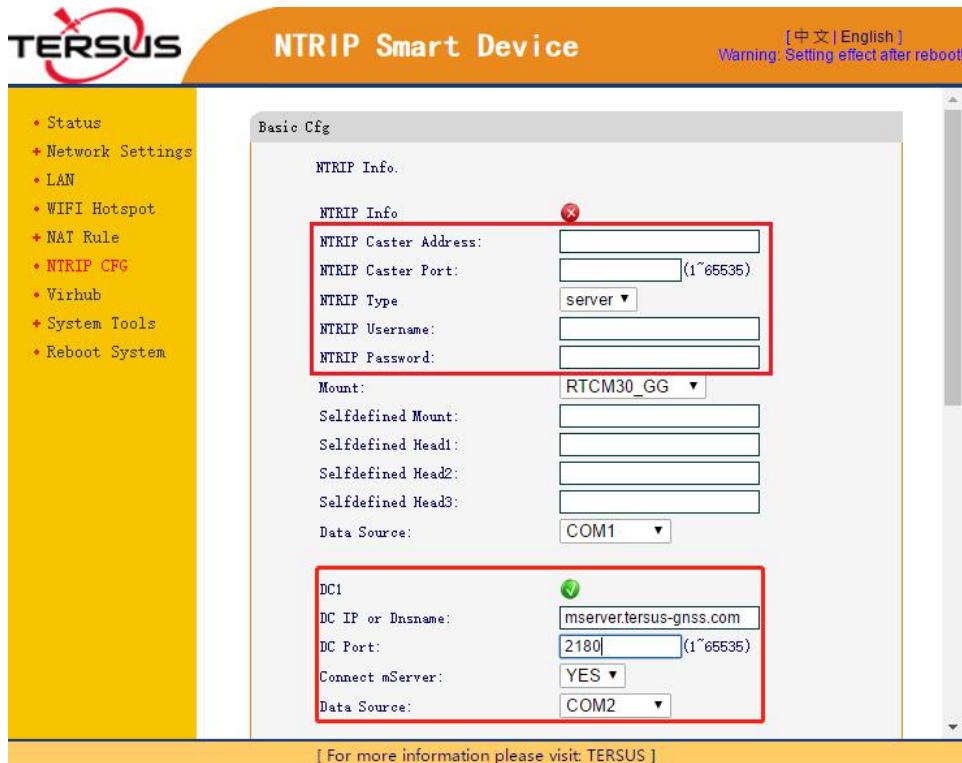

Figure 2.8 Set Ntrip info in Ntrip configuration interface

- 9) Turn on the virtual hub function and configure Virhub according to the information which is shown below. It is pre-configured as default. Contact Tersus Technical Support if users need other server for the Virhub configuration.

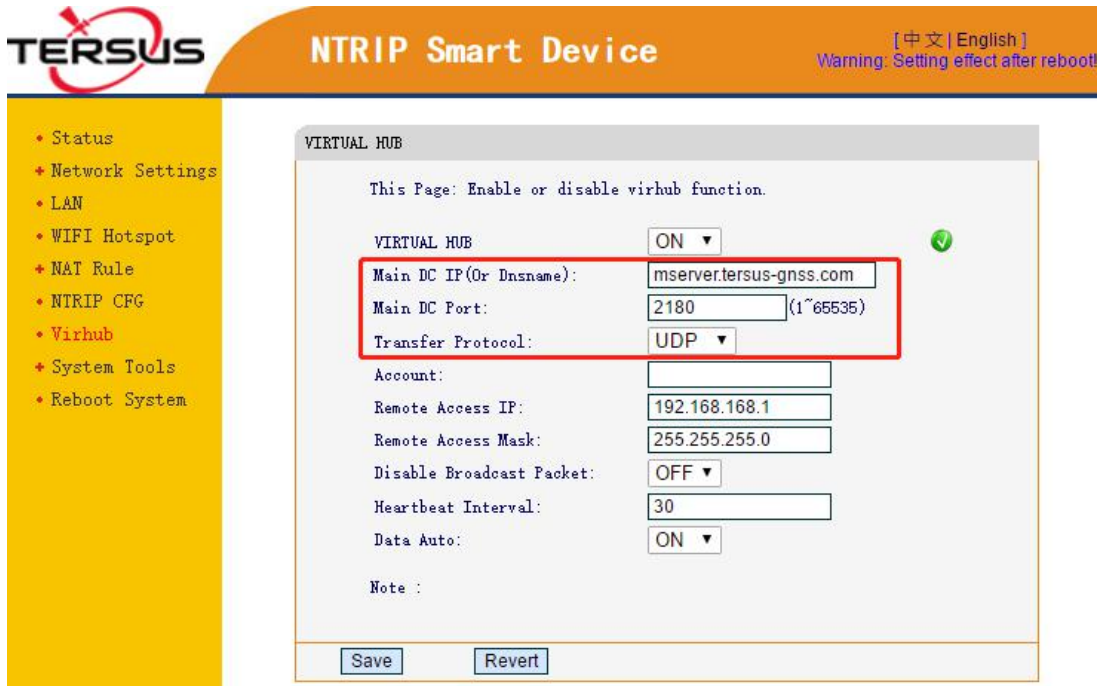

Figure 2.9 Set Virhub configuration

10) After setting the above configurations, click [Save] and reboot the device to active the configuration. The configuration becomes effective only after the Ntrip Modem TR600 is restarted.

Note: the mserver software and Verhub software are under development, stay tuned.

2.2 Configuration Parameters

The configuration menu of David GNSS receiver can be viewed on Nuwa app, the detailed usage of Nuwa app refers to the user manual of Nuwa app which can be downloaded on Tersus official website

<https://www.tersus-gnss.com/document/david-receiver> under the User Manual section.

Each configuration menu of Ntrip Modem TR600 has multiple parameters, and some of them have sub-menus. The detailed configuration parameters refer to section 2.2 of the user manual of Ntrip Modem TR600.

2.3 Factory Reset

The factory reset of David GNSS receiver can be completed on Nuwa app by clicking [Reset] on the Device Info interface. The detailed usage of Nuwa app refers to the user manual of Nuwa app which can be downloaded on Tersus official website <https://www.tersus-gnss.com/document/david-receiver> under the User Manual section.

In the TR600 configuration interface, select 'Restore Set' under 'System Tools', click [Restore Set] to reset to factory settings; or long press the RESET button to reset.

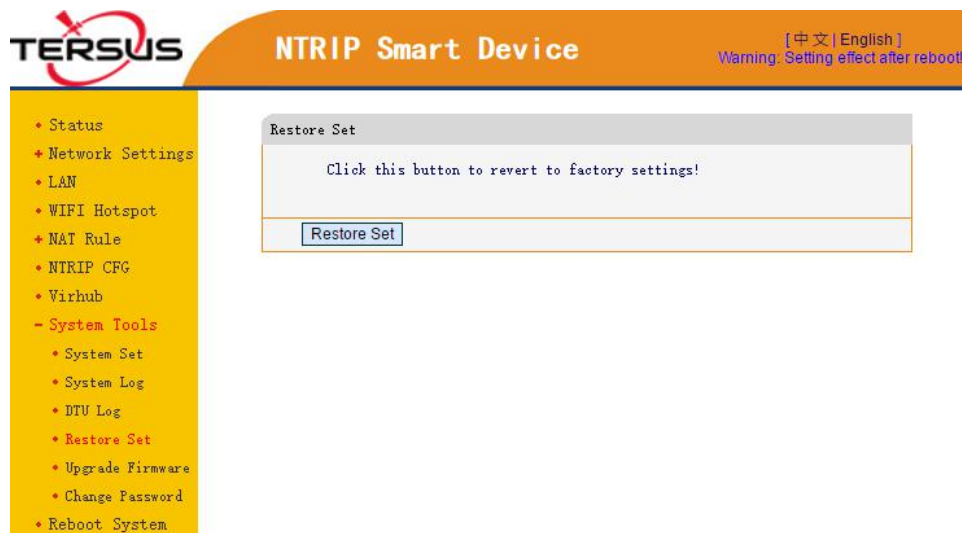

Figure 2.10 Factory Reset for TR600

2.4 Firmware Upgrade

The updated firmware is released and available for downloading on Tersus

web site <https://www.tersus-gnss.com/software> , or it can be obtained from Tersus technical support. After completing the hardware connection mentioned in 2.1.2 Configure David, launch the TersusUpdate software on the desktop or click [Tools] -> [UpdateFirmware] in Tersus GNSS Center software.

In the TersusUpdate interface, the software recognizes the serial port and scans the baud rate automatically. Select the Port which is connected to David receiver, browse the location for the updated firmware file, and click [Next] to update the firmware.

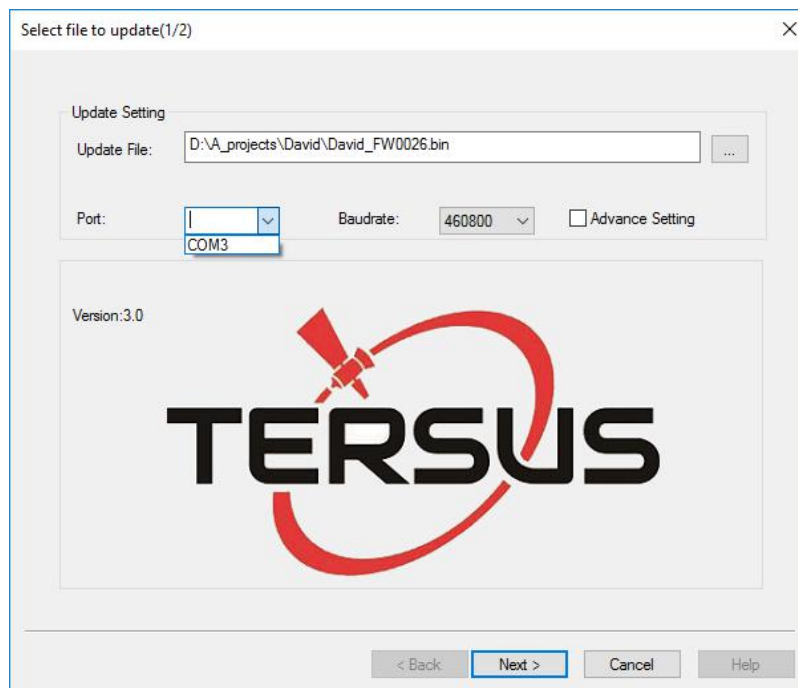

Figure 2.11 Update firmware for David

Contact Tersus Support for firmware file to upgrade Ntrip Modem TR600. Select 'Upgrade Firmware' under 'System Tools' in the TR600 configuration interface, choose the firmware file, and click [Upload/Download] to upload the firmware.



Figure 2.12 Update firmware for TR600

Wait for a few minutes until 'Update' is shown, choose 'Delete the former file'. Click [Update], it will prompt that the file system has been updated, the original setting is cleared, and the system is rebooting.

2.5 Observation Data Storage

Since it is not supported to download observation data remotely, it is recommended using RTKLIB, an open source program for GNSS positioning, to store the observation data as a file in the computer.

The detailed steps of how to store observation data into a computer are as follows:

- 1) Download RTKLIB software from its official website <http://www.rtklib.com/> , unzip the zip file and find the application rtklaunch.exe
- 2) Double click rtklaunch.exe and then click the third icon to launch STRSVR function.

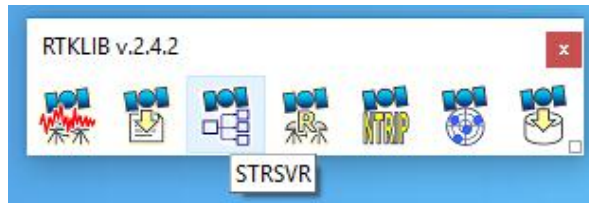

Figure 2.13 Launch STRSVR in RTKLIB

- 3) In the STRSVR interface, select 'NTRIP Client' as input type, click the Opt button on the right, fill all the information for NTRIP Client Options and then click [OK].

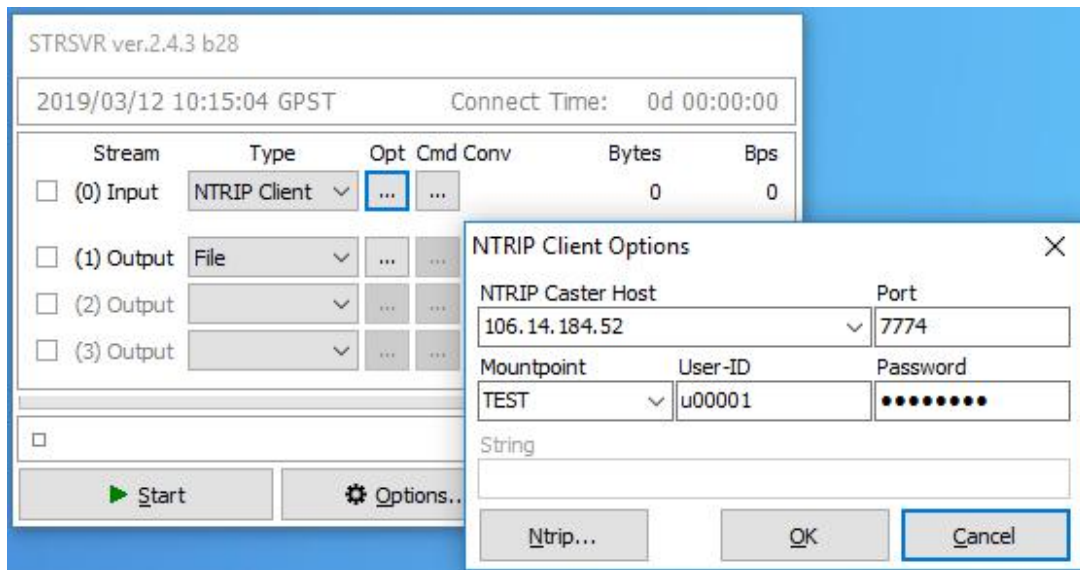

Figure 2.14 Input NTRIP Client information

- 4) Select 'File' as output type, click the Opt button on the right, browse a location for the Output File Path, and click [OK].

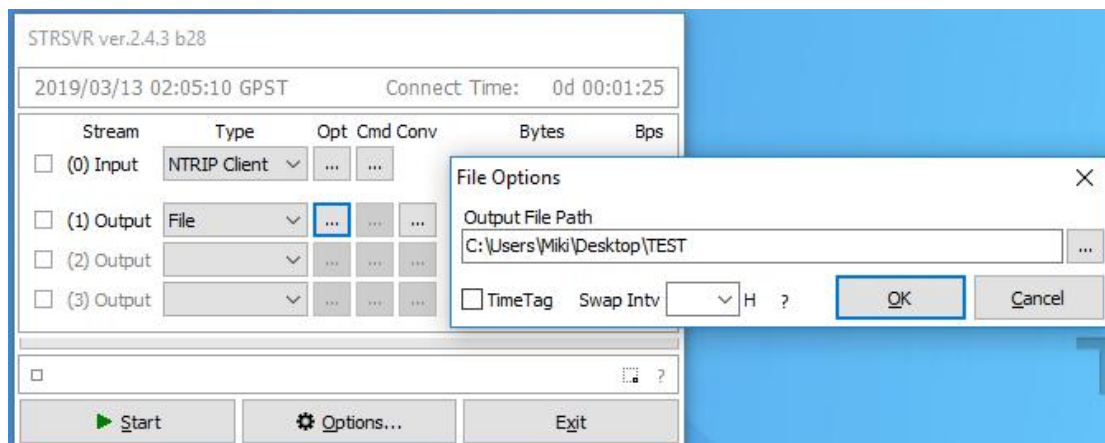

Figure 2.15 Output information

- 5) Go back to the main page, and click [Start]. The observation data will be

stored in file of the designated folder. The file is being saved as shown below.

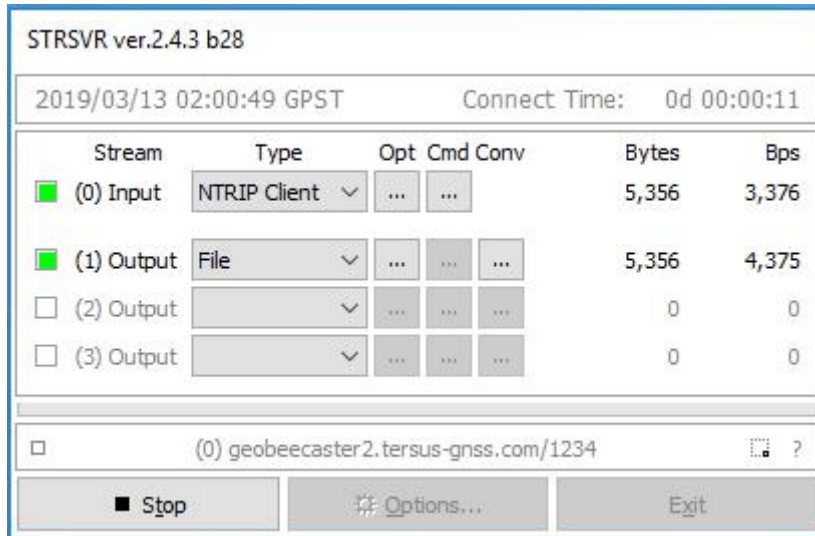

Figure 2.16 Start saving observation data

3. Specifications

This chapter includes the specifications of David GNSS Receiver, AX3702 GNSS Antenna and TR600 Ntrip Modem.

3.1 David GNSS Receiver

Table 2 David GNSS Performance

GNSS Performance		
Position Accuracy	Single positioning	1.5m RMS (Horizontal)
		3.0m RMC (Vertical)
	RTK Positioning	10mm+1ppm (Horizontal)
		15mm+1ppm (Vertical)
	Static post processing	3mm+0.5ppm (Horizontal)
		5mm+0.5ppm (Vertical)
Time to First Fix	Cold Start: <50s Warm Start: <30s	
Reacquisition	0.5s L1 (typical) 1.0s L2 (typical)	
Data Rate	Measurements	20Hz
	Position	5Hz
Time Accuracy	20ns RMS	
Velocity Accuracy	0.03m/s RMS	
Measurement Precision	C/A Code	10cm
	P Code(zenith direction)	10cm
	Carrier Phase (zenith direction)	1mm
Physical Description		
Dimension	104*65*31 mm (David only)	

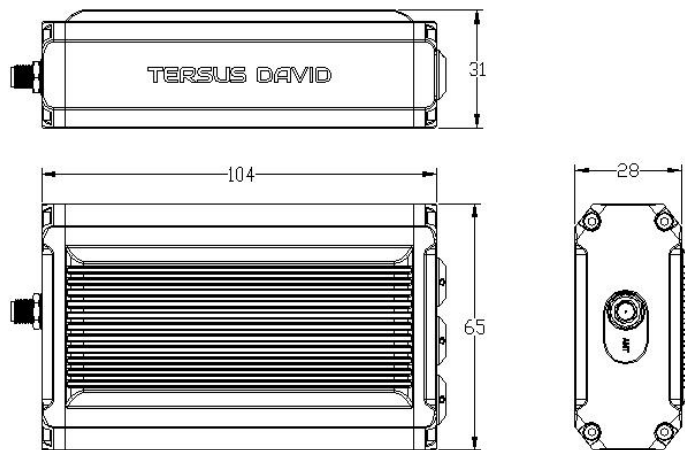
Weight	250g (David only)
Mechanical Drawing	
	
Environmental	
Operating Temperature	-40°C to +85°C
Storage Temperature	-55°C to +95°C
Humidity	MIL-STD-810G, Method 507.5 Procedure II (95%)
Random Vibration	MIL-STD 810G Method 514.6, Category 24 (7.7 g RMS)
Sinusoidal Vibration	IEC 60068-2-6 (5 g)
Bump	ISO 9022-31-06 (25 g)
Shock	Operating: MIL-STD-810G, Method 516.6, Procedure I (40 g) Non-operating: MIL-STD-810G, Method 516.6, Procedure V (75 g)
Water & dust proof	IP67
Power Requirement	
Input Voltage	+5 – 12 VDC
Power Consumption	3.2W without external Radio 9.8W with external 2W radio

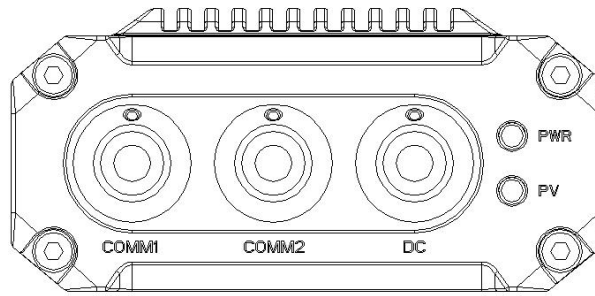

Figure 3.1 Panel of David

Table 3 Pin Definition of connectors on David

Connector Pin No.	COMM1 LVTTL	COMM2 RS-232	DC
1	PWR	PWR	PWR
2	GND	GND	GND
3	TXD1	TXD2	
4	RXD1	RXD2	
5	GND	GND	
6	CAN_H/PPS ¹	USB D+	
7	CAN_L/EVENT ¹	USB D-	

Note 1: The default configurations for pin 6 and pin 7 of COMM1 port are CAN_H and CAN_L. The two signals are multiplexed with PPS and EVENT. This feature is related to firmware release, contact support@tersus-gnss.com for confirmation.

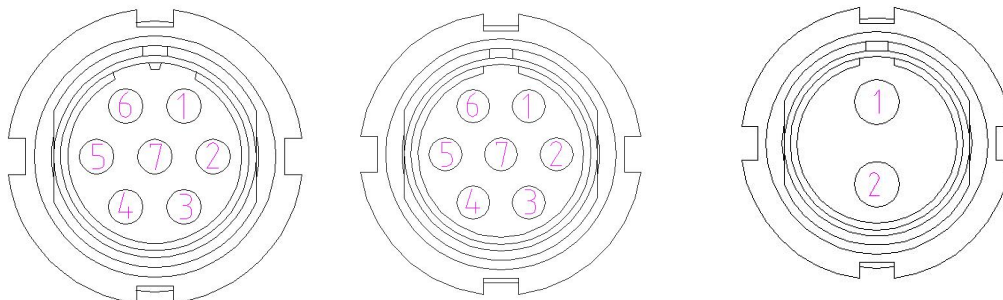
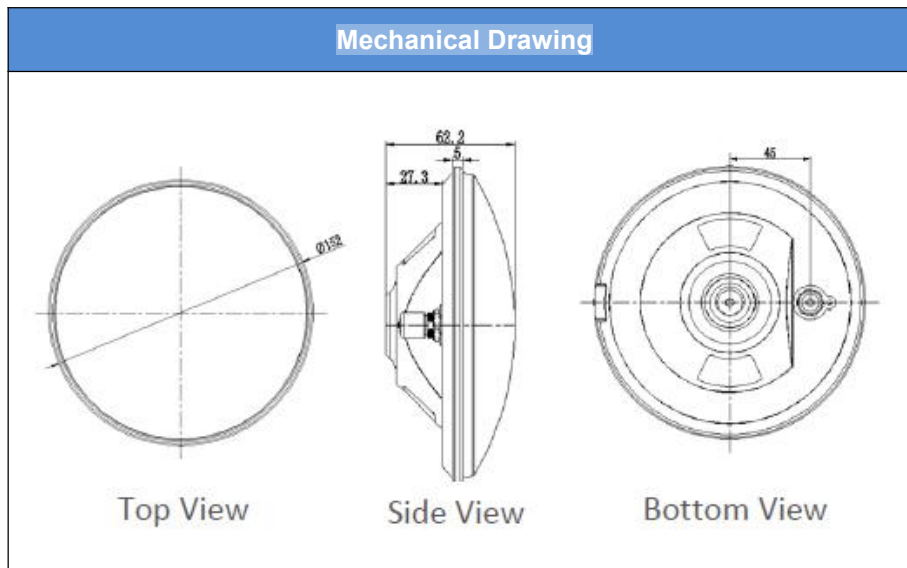

Figure 3.2 Pin Definition of the COMM1/COMM2/DC ports

3.2 AX3702 GNSS Antenna

Table 4 AX3702 GNSS Antenna

Antenna Specification	
Tracking signals	GPS L1/L2/L5; BDS B1/B2/B3; GLONASS L1/L2
Impedance	50 Ohm
Polarization	RHCP
Axial Ratio	≤ 3dB
Azimuth Coverage	360°
Output VSWR	≤ 2.0
Peak Gain	5.5dBi
Phase Center Error	± 2mm
LNA Specification	
LNA Gain	40±2dB
Noise Figure	≤ 2.0dB
VSWR	≤ 2.0
Input Voltage	3.3~12V DC
Operating Current	≤ 45mA
Ripple	± 2dB
Physical Description	
Dimension	Φ152*62.2mm
Weight	374g
Signal Connector	TNC Female
Installation connector	5/8" x 11
Environment	
Operating temperature	-45°C - +85°C
Storage temperature	-45°C - +85°C
Damp	45% - 95%



3.3 TR600 Ntrip Modem

Table 5 Ntrip Modem TR600 specifications

Electrical	
Input Voltage	+12 ~ +48V DC
Operating Current	350mA @ +12V DC
Standby Current	250mA @ +12V DC
Power Consumption	4.2W (typical)
Network	
Chinese version	2G: GSM/GPRS/EDGE/CDMA2000 1x 3G: UMTS/WCDMA/HSPA/HSPA+/TD-SCDMA/CDMA2000 EVDO 4G: TDD-LTE/FDD-LTE
Eurasian version (Europe, Middle East, Africa, South Korea, Thailand)	2G: GSM/GPRS/EDGE 3G: UMTS/WCDMA/HSPA/HSPA+ 4G: TDD-LTE/FDD-LTE
North American version	3G: UMTS/WCDMA/HSPA/HSPA+ 4G: FDD-LTE
Australian version (New)	2G: GSM

Zealand, Australia, South America)	3G: WCDMA 4G: FDD-LTE/TDD-LTE
Operating Frequency Band	
Chinese version	TDD-LTE B38/B39/B40/B41 FDD-LTE B1/B3/B8 UMTS/HSDPA/HSPA+ B1/B8 TD-SCDMA B34/B39 CDMA2000 1x/EVDO BC0 GSM/GPRS/EDGE 900/1800 MHz
Eurasian version	TDD-LTE B38/B40 FDD-LTE B1/B3/B7/B8/B20 UMTS/HSDPA/HSPA+ B1/B8 GSM/GPRS/EDGE 900/1800 MHz
North American version	FDD-LTE B2/B4/B5/B17 UMTS/HSDPA/HSPA+ B2/B5
Australian version	FDD-LTE B1/B2/B3/B4/B5/B7/B8/B28 TDD-LTE B40 WCDMA B1/B2/B5/B8 GSM 850/900/1800/1900
Interfaces	
Serial Port	RS232 x1, RS485 x1
Ethernet	RJ45 x2 (LAN, LAN/WAN)
Antenna Connector	SMA Female x1
Physical	
Dimension	118x91x34mm (w/o connectors)
Weight	335g
Operating Temperature	-30°C ~ +80°C
Relative Humidity	95% @ +40°C

4. Typical Application

Typically, GeoBee can work under both Ntrip server mode and Ntrip client mode. The system structure for them is the same, the configuration of Ntrip Modem TR600 is different.

4.1 GeoBee working under Ntrip server mode

If GeoBee is configured to work under Ntrip server mode, fill in the Ntrip information under the [NTRIP CFG] sub menu. Select [server] in the drop-down menu of Ntrip Type, type in the Ntrip password and click [Save] at the bottom of this page to complete the configuration.

The Ntrip information can be found on Ntrip Modem TR600. If there is any question, please contact Tersus Technical Support by email support@tersus-gnss.com without any hesitate.



Figure 4.1 GeoBee under Ntrip server mode

4.2 GeoBee working under Ntrip client mode

If GeoBee is configured to work under Ntrip client mode, fill in the Ntrip information under the [NTRIP CFG] sub menu. Select [client] in the drop-down menu of Ntrip Type, type in the Ntrip Username and Ntrip password, and click [Save] at the bottom of this page to complete the configuration.

The Ntrip information can be found on Ntrip Modem TR600. If there is any question, please contact Tersus Technical Support by email support@tersus-gnss.com without any hesitate.



Figure 4.2 GeoBee under Ntrip client mode

4.3 Check Link Status using Web portal

Open any browser on your computer (accessible to the Internet) and enter the following URL in the address bar: <http://geobecaster2.tersus-gnss.com:2101/>

In the login window, type the (Ntrip) Client User and (Ntrip) Client Password which are shown on the label of the Ntrip Modem TR600.

```

NtripName:
geobecaster2.tersus-gnss.com
NtripPort: 2101
Client User: geobeetest1
Client Password: s65uhkJd
Default Mount Point: 240305085154981
    
```

After a successful login, the link status is shown in the figure below:

Current Time:19-03-19 03:56:19(-0000)

Server/Client Current Status

S/C	From IP	MountPoint	StartTime	Data Bytes(KB)	Data Type	lat/long/ellipsoid height
Server	221.178.124.152	2403050050	19-03-19 02:02:35(-0000)	2896.824	RTCM3	594690/11883409/107.4092

Statistics

MountPoint	First Start Time	PAS Count/ideal	total online rate(%)	Error/Valid Package	lat/long/ellipsoid height
2403050050	18-12-13 02:52:14(-0000)	2569/4610	55.74	0/15265991	594690/11883409/107.4092

240305005050828 Hourly online rate from 03/17 to 03/19(-0000)

00 01 02 03 04 05 06 07 08 09 10 11 12 13 14 15 16 17 18 19 20 21 22 23

03/17 100 100 99 100 100 97 97 98 99 100 97 100 99 100 100 100 100 100 100 100 100 100

03/18 100 100 100 100 100 100 100 99 100 100 100 100 100 100 100 100 100 100 100 100 100 100

03/19 100 100 99 93

5. Terminology

BDS	BeiDou Navigation Satellite System
DC	Direct Current
eMMC	Embedded Multi Media Card
EXIF	Exchangeable Image File Format
GLONASS	GLObal NAVigation Satellite System
GNSS	Global Navigation Satellite System
GPS	Global Positioning System
MSL	Mean Sea Level
PC	Personal Computer
PPK	Post-Processing Kinematic
PPS	Pulse Per Second
RINEX	Receiver Independent Exchange format
RMS	Root Mean Squares
RTK	Real-Time Kinematic
RTCM	Radio Technical Commission for Maritime Services
UAV	Unmanned Aerial Vehicle, drone
USB	Universal Serial BUS

Proprietary Notice

All Information in this document is subject to change without notice and does not reflect the commitment on Tersus GNSS Inc. No part of this manual may be reproduced or transmitted by all means without authorization of Tersus GNSS Inc. The software described in this document must be used in terms of the agreement. Any modification without permission from Tersus GNSS Inc. is not allowed.