

User Manual

Version V2.0-20190131

User Manual For David GNSS Receiver

©2019 Tersus GNSS Inc. All rights reserved.



Sales & Technical Support:

sales@tersus-gnss.com & support@tersus-gnss.com

More details, please visit www.tersus-gnss.com



Revision History

Version	Revision Date	Change summary
1.0	20180702	Initial Release
2.0	20190131	Chapter 2: removed rover kit with 1W radio and base kit with 1W radio, update device names; Chapter 3: section 3.4 firmware update; Chapter 5: removed specification of 1W radio, add frequency configuration for 2W and 30W radio; Chapter 6: changed detailed steps in table to paragraphs, updated related screenshots, added operations for 2W radio and 30W radio.

Table of Content

Revision History.....	1
Table of Content.....	2
List of Figures.....	5
List of Tables.....	9
Notices.....	10
1. Overview.....	12
1.1 Introduction.....	12
1.2 Receiver Features.....	13
1.3 Brief Introduction of GNSS and RTK.....	13
2. Devices in David Package.....	16
2.1 Rover Kit Network Mode.....	17
2.1.1 David GNSS Receiver.....	19
2.1.2 AX3702 GNSS Antenna.....	20
2.1.3 DC-2pin to USB Power Cable.....	21
2.1.4 COMM1-Bluetooth Module.....	21
2.1.5 COMM2-7pin to USB & DB9 Cable.....	22
2.1.6 DB9 Male to USB Type A Male converter cable.....	23
2.1.7 USB Type A Female to USB (Micro + Type C) OTG cable.....	23
2.1.8 Height Measure Accessory.....	24
2.1.9 Wrench.....	24
2.1.10 Other accessories.....	24
2.2 Rover Kit with 2W Radio Station.....	27
2.2.1 2W/460MHz Radio.....	29
2.2.2 2W/460MHz Radio Antenna.....	30
2.2.3 COMM2-7pin to USB & 2W-Radio-5pin Cable.....	31
2.2.4 TNC-J to TNC-J Cable 1.0m (Radio Antenna Extension Cable).....	31

2.2.5	Bracket for 460M antenna with TNC-TNC converter.....	32
2.3	Base Kit Network Mode.....	32
2.3.1	Bracket for Base.....	34
2.3.2	Tape Measure.....	34
2.3.3	Other accessories.....	35
2.4	Base Kit with 2W Radio Station.....	35
2.4.1	DC-2pin to Bullet-DC Power cable.....	38
2.4.2	Bullet-DC to Alligator Clip.....	38
2.4.3	High Gain Radio Antenna.....	38
2.4.4	Metal plate for radio antenna.....	39
2.4.5	Telescopic pole for radio antenna.....	39
2.4.6	Hook and Screws for 2W Radio.....	40
2.4.7	Hook and Screws for David.....	40
2.4.8	Bracket for Mobile.....	40
2.4.9	Other accessories.....	41
2.5	Base Kit with 30W Radio Station.....	41
2.3.1	30W Radio.....	44
2.3.2	DC-2pin & 30W-Radio-DC-2pin to Bullet-DC.....	45
2.3.3	COMM2-7pin to USB & 30W-Radio-5pin Cable.....	45
3.	General operation.....	46
3.1	Install the GNSS antenna.....	46
3.2	Power on David.....	46
3.3	Communication between Android phone and David.....	48
3.3.1	Wires connection.....	48
3.3.2	External Bluetooth Connection.....	50
3.4	Firmware Update.....	52
3.4.1	Hardware Connection.....	52
3.4.2	USB to Serial COMM Port driver.....	52
3.4.3	Firmware Update.....	55
3.5	Auth Code.....	60

3.6	Download Files from Internal EMMC Card.....	61
3.7	Input command directly to the GNSS board.....	63
4.	Introduction of Nuwa.....	65
5.	Specification.....	68
5.1	David Receiver.....	68
5.2	Antenna AX3702.....	71
5.3	2W Radio RS400L2.....	72
5.4	30W Radio RS400L30.....	75
6.	Typical operation.....	78
6.1	David as a Rover to receive corrections from Internet.....	79
6.2	David as a Base to transmit corrections to Internet.....	82
6.3	Radios Transmit RTK Corrections between Two David receivers.....	85
6.4	Data Collection for Post Processing.....	89
6.5	Auto Base Station List Function.....	92
6.6	2W Radio operation.....	94
6.7	30W Radio operation.....	97
7.	Terminology.....	100

List of Figures

Figure 1.1 Outlook of David GNSS receiver.....	12
Figure 1.2 Outline of David System.....	14
Figure 1.3 Corrections transmitted via Internet.....	14
Figure 1.4 Corrections transmitted with radios.....	15
Figure 2.1 Devices in the box.....	16
Figure 2.2 Rover Kit Network Mode.....	17
Figure 2.3 David GNSS Receiver.....	19
Figure 2.4 AX3702 GNSS Antenna.....	20
Figure 2.5 TNC-J to SMA Cable 1.5m (GNSS antenna cable).....	20
Figure 2.6 GNSS Antenna Connector.....	21
Figure 2.7 DC-2pin to USB Power Cable.....	21
Figure 2.8 COMM1-Bluetooth Module.....	21
Figure 2.9 COMM2-7pin to USB & DB9 Cable.....	22
Figure 2.10 DB9 Male to USB Type A Male converter cable.....	23
Figure 2.11 USB Type A Female to USB (Micro + Type C) OTG cable.....	23
Figure 2.12 Height Measure Accessory.....	24
Figure 2.13 Wrench.....	24
Figure 2.14 Bracket for Rover.....	25
Figure 2.15 Ranging Pole.....	25
Figure 2.16 Magic Tape.....	25
Figure 2.17 Carrying Case for Rover.....	26
Figure 2.18 Power Bank.....	26
Figure 2.19 Rover Kit with 2W Radio Station.....	27
Figure 2.20 2W/460MHz Radio.....	29
Figure 2.21 2W/460MHz radio antenna.....	30
Figure 2.22 COMM2-7pin-USB & 2W-Radio-5pin Cable.....	31
Figure 2.23 TNC-J to TNC-J cable 1.0M (Radio Antenna Extension Cable).....	31

Figure 2.24 Bracket for 460M antenna with TNC – TNC converter.....	32
Figure 2.25 Base Kit Network Mode.....	33
Figure 2.26 Bracket for Base.....	34
Figure 2.27 Tape Measure.....	35
Figure 2.28 Carrying Case for Base.....	35
Figure 2.29 Base Kit with 2W Radio.....	36
Figure 2.30 DC-2pin to Bullet DC Power Cable.....	38
Figure 2.31 Bullet-DC to Alligator Clips.....	38
Figure 2.32 High Gain Radio Antenna.....	39
Figure 2.33 Metal plate for radio antenna.....	39
Figure 2.34 Telescopic pole for radio antenna.....	39
Figure 2.35 Hook and Screws for 2W Radio (attached to 2W radio).....	40
Figure 2.36 Hook and Screws for David (attached to David).....	40
Figure 2.37 Bracket for Mobile.....	41
Figure 2.38 Toolbag.....	41
Figure 2.39 Base Kit with 30W Radio.....	42
Figure 2.40 30W Radio Station.....	44
Figure 2.41 DC-2pin & 30W-Radio-DC-2pin to Bullet-DC.....	45
Figure 2.42 COMM2-7pin to USB & 30W-Radio-5pin Cable.....	45
Figure 3.1 Outline of Android phone to David with Wires.....	48
Figure 3.2 Connect using USB cable.....	49
Figure 3.3 Outline of Android phone to David with Bluetooth.....	50
Figure 3.4 Connect using Bluetooth.....	51
Figure 3.5 Search Bluetooth device.....	51
Figure 3.6 Outline of David connected to a Computer.....	52
Figure 3.7 COM port is recognized by the computer in the Computer Management.....	54
Figure 3.8 Update Driver Software manually.....	54
Figure 3.9 Two methods of searching for driver software.....	55

Figure 3.10 PC software icons on desktop.....	56
Figure 3.11 Firmware Settings in TersusUpdate software.....	56
Figure 3.12 Update Progress of the firmware update.....	57
Figure 3.13 Firmware update successful interface.....	57
Figure 3.14 Advance Setting for firmware update.....	59
Figure 3.15 Device Information interface on Nuwa app.....	61
Figure 3.16 Download file from EMMC card.....	61
Figure 3.17 File download using TersusDownload.....	62
Figure 3.18 Select serial port for Download Port.....	62
Figure 3.19 Select download speed.....	62
Figure 3.20 File downloading in process.....	63
Figure 3.21 Input command in Data Terminal on Nuwa app.....	64
Figure 4.1 Booting up page of Nuwa app.....	65
Figure 4.2 Nuwa app interface 1 – Project.....	66
Figure 4.3 Nuwa app interface 2 – Device.....	66
Figure 4.4 Nuwa app interface 3 – Survey.....	67
Figure 4.5 Nuwa app interface 4 – Tools.....	67
Figure 5.1 Panel of David.....	70
Figure 5.2 Pin Definition of the COMM1/COMM2/DC ports.....	70
Figure 6.1 Outline of Android phone to David with Wire – Rover.....	79
Figure 6.2 Connect David via USB.....	80
Figure 6.3 Rover setting interface.....	81
Figure 6.4 Edit Rover configuration.....	81
Figure 6.5 Rover is receiving RTK corrections.....	81
Figure 6.6 Outline of Android phone to David with Wire – Base.....	82
Figure 6.7 Connect David via USB.....	83
Figure 6.8 Base setting interface.....	84
Figure 6.9 Edit Base configuration.....	84
Figure 6.10 Base is transmitting corrections.....	84

Figure 6.11 Outline of Base/Rover with Radios.....	85
Figure 6.12 Base work mode list.....	87
Figure 6.13 Edit base configuration.....	87
Figure 6.14 Rover work mode list.....	88
Figure 6.15 Edit rover configuration.....	88
Figure 6.16 Outline of Static Data Collection.....	90
Figure 6.17 Survey interface on Nuwa app.....	91
Figure 6.18 Static survey configuration.....	91
Figure 6.19 Auto Base Station List interface.....	92
Figure 6.20 Fixed position for base station.....	93
Figure 6.21 Front Panel of the 2W Radio.....	94
Figure 6.22 Front Panel of the 30W Radio.....	97

List of Tables

Table 1 Document / software used in this user manual.....	10
Table 2 Five David Variants.....	16
Table 3 Devices in Rover Network Mode.....	18
Table 4 Definition of LEDs.....	19
Table 5 Functions of COMM2-7pin to USB & DB9 Cable.....	22
Table 6 Rover Kit with 2W Radio Station.....	28
Table 7 Button Description for 2W/460MHz Radio.....	29
Table 8 LED Definition.....	30
Table 9 Base Kit with 30W Radio Station.....	43
Table 10 Definition of the Control Buttons.....	44
Table 11 Definition of LEDs.....	44
Table 12 David GNSS Performance.....	68
Table 13 Pin Definition of connectors on David.....	70
Table 14 Antenna AX3702.....	71
Table 15 Specifications of 2W Radio RS400L2.....	72
Table 16 Default factory configuration for RS400L2.....	74
Table 17 Specifications of 5W Radio RS400L30.....	75
Table 18 Default factory configuration for RS400L30.....	77
Table 19 List of Terminology.....	100



Notices

The following notices apply to DAVID GNSS receiver.

	Changes or modifications to this equipment not exactly approved by Tersus could void the user's authority to operate this equipment or even has risk to damage the DAVID.
---	---

Conventions

The following conventions are used in this manual:

	Information that supplements or clarifies text.
	A caution that actions, operations or configurations may lead to incorrect or improper use of the hardware.
	A warning that actions, operations or configurations may result in regulatory noncompliance, safety issues or equipment damage.

NUWA is Tersus survey app, four tabs (Project, Device, Survey and Tools) are provided in the Nuwa main interface. All the operations in the Survey software start from these four tabs.

For all the figures in this manual, a line with two arrows at the two sides means a cable. A line with one arrow gives the installation direction.

Table 1 Document / software used in this user manual

Name	Description	Link
Log & Command document	Document providing all the loggings output from David and all the commands to David	https://www.tersus-gnss.com/document under GNSS OEM Boards / User Manual

Tersus Tool Suite	Tersus Tools including TersusDownload, TersusGeoPix, TersusGNSSCenter, TersusUpdate, TersusRinexConverter	https://www.ter sus-gnss.com/software/ david-receiver
Nuwa	Survey application running in the Android platform, David can be configured with Nuwa.	https://www.ter sus-gnss.com/software/ david-receiver
Tersus Geomatics Office	Post processing tool for static data	https://www.ter sus-gnss.com/software/ david-receiver

Support

If there is any problem and the information needed cannot be found in the product documentation, request technical support using the Tersus website at www.ter sus-gnss.com, or mail to support@ter sus-gnss.com

1. Overview

1.1 Introduction

Tersus DAVID is a cost-efficient, palm-sized GNSS receiver, mainly for the mass survey market, and also for UAV / AGV / Agriculture application.

Nuwa, a survey App on Android system, works with David for the survey. And David receiver can communicate with an Android platform such as a phone or tablet via USB cable or an external Bluetooth module. The David receiver can work as a base or a rover, it supports real-time RTK positioning as well as saving data for PPK application. Up to 4GB on-board EMMC card makes it easy to save data for PPK application.

The RS-232 serial port, IP67 standard and the external Bluetooth module can remove most of the inconvenience for field workers. All the operations can be done in the Nuwa app except downloading raw measurement data file, which should be completed using Tersus GNSS Center, refer to Table 1 and section Download Files from Internal EMMC Card for detail.



Figure 1.1 Outlook of David GNSS receiver

1.2 Receiver Features

- Supports GPS L1/L2, BDS B1/B2 and GLONASS L1/L2.
- Supports RTCM2.3/3.x, CMR, CMR+ corrections.
- Easy to connect an external powerful radio for longer range.
- Solution rate can be 5Hz.
- 20Hz raw measurements output for post processing.
- The accuracy of carrier phase can be 1mm.
- On-board 4GB EMMC card for data collection
- Static post-processing for mm-level accuracy.
- Bluetooth module makes wireless connection.
- Input power range is 5 – 12V, connect to power bank directly.
- IP67 for water & dust proof, work reliably in harsh condition

1.3 Brief Introduction of GNSS and RTK

Tersus BX306 GNSS receiver is integrated in David, the board is receiving the GNSS signals from satellites and RTK corrections from the base, and is outputting cm-level position, velocity and time. Figure 1.2 shows the outline of David system; refer to <https://www.tersus-gnss.com/product/bx306-oem-board> for more details about BX306 receiver.

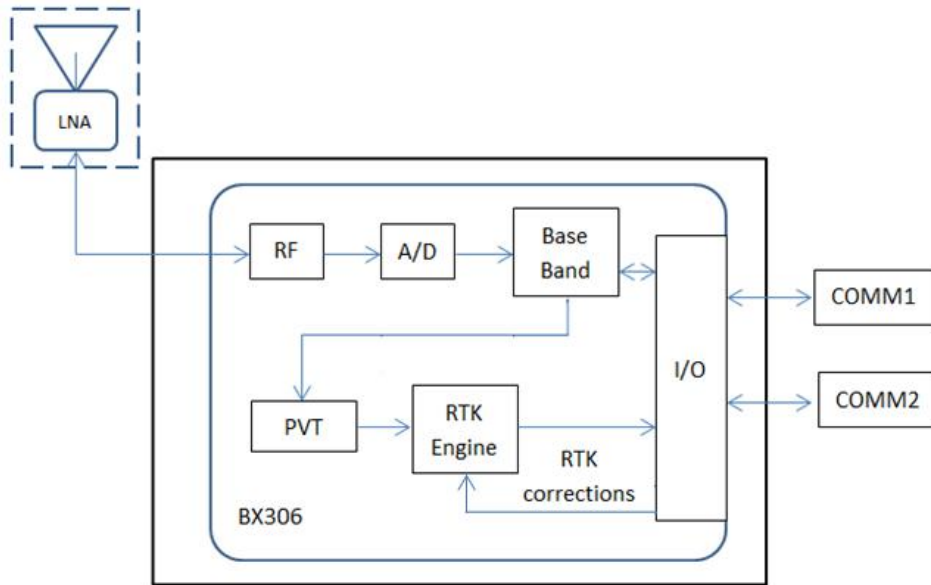

Figure 1.2 Outline of David System

The RTK corrections are transmitted from a base, which can be a CORS station or a David receiver. The RTK corrections can be transmitted to the rover via Internet or with external radios.

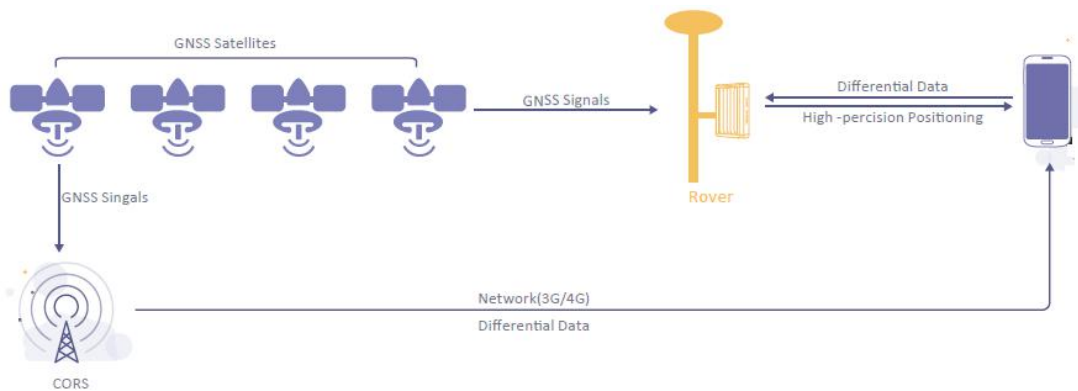

Figure 1.3 Corrections transmitted via Internet

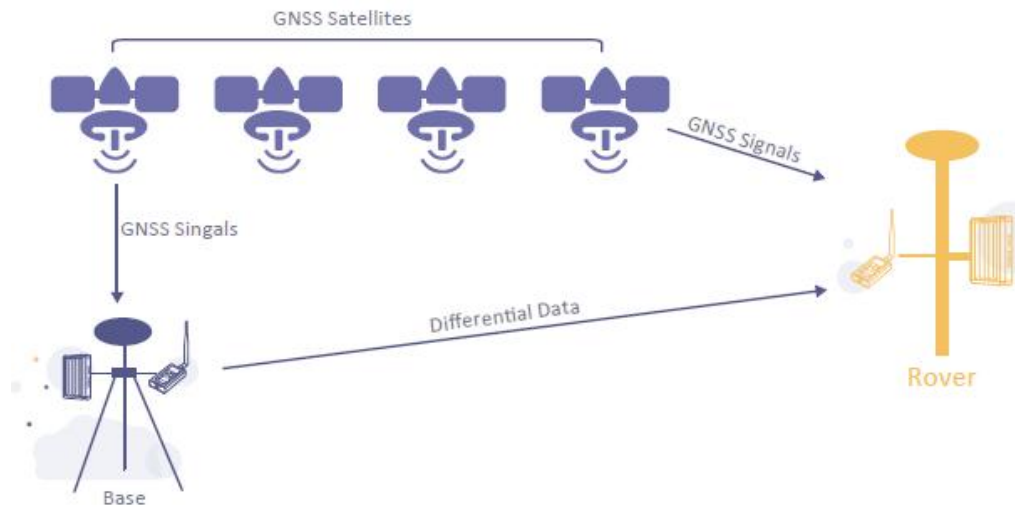

Figure 1.4 Corrections transmitted with radios

If RTK corrections are transmitted via Internet, an Android phone or controller will be included in the RTK system to transmit/receive the RTK corrections, refer to section 6.1 and section 6.2 for detailed operations.

2. Devices in David Package

This chapter is to give detailed introduction about all the devices in the package. David has five variants, which are convenient for customers to select according to their application. Different accessories are included in each variant. Table 2 gives a brief description of the five variants. For more details, refer to section 2.1 to section 2.5. All the five variants are shipped in a yellow plastic box in Figure 2.1.



Figure 2.1 Devices in the box

Table 2 Five David Variants

David variants	Description
Rover Kit Network Mode	The David receiver will receive RTK corrections from a NTRIP caster or a TCP server.
Rover Kit with 2W Radio Station	The David receiver will receive RTK corrections from an external 2W 460MHz radios.
Base Kit Network Mode	The David receiver will output RTK corrections to a NTRIP caster or a TCP server.
Base Kit with 2W Radio Station	The David receiver will output RTK corrections to an external 2W 460MHz radio.
Base Kit with 30W Radio Station	The David receiver will output RTK corrections to an external 30W 460MHz radio.

!	<ol style="list-style-type: none"> 1. Rover Kit Network Mode and Base Kit Network Mode can work independently. 2. Rover Kit with 2W Radio Station must work with Base Kit with 2W Radio Station or Base Kit with 30W Radio Station.
---	---

2.1 Rover Kit Network Mode

In this variant, the David is connected to an Android phone or controller with Bluetooth module or with cables. Tersus Survey Nuwa App is installed and run in the Android phone or controller to receive RTK corrections from a NTRIP caster or a TCP server.

Refer to section 6.1 for detailed operation.



Figure 2.2 Rover Kit Network Mode

!	<p>The power bank and controller in are not included in the package. The TC20 controller is listed on</p>
---	---

<https://www.tersus-gnss.com/product/tc20-controller>

Table 3 Devices in Rover Network Mode

Device Name	Quantity	Items in Figure 2.2
AX3702 GNSS antenna	1	1
Ranging pole	1	2
TC20 Controller	1	3, not included in the package
COMM1-Bluetooth module	1	4, refer to section 2.1.4
DC-2pin to USB power cable	1	5, refer to Figure 2.7
Power bank	1	6, not included in the package, refer to Figure 2.18 and Power on David
David GNSS receiver	1	7
Bracket for rover	1	8, refer to section 2.1.10
GNSS antenna cable	1	9
GNSS antenna connector	1	Not in the figure above, refer to section 2.1.2 for detail.
COMM2-7pin to USB & DB9 cable	1	Not in the figure above, refer to section 2.1.5 for detail.
DB9 Male to USB Type A Male converter cable	1	Not in the figure above, refer to Figure 2.10 for detail.
USB Type A Female to USB (Micro + Type C) OTG cable	1	Not in the figure above, refer to Figure 2.11 for detail.
Height measure accessory	1	Not in the figure above, refer to Figure 2.12 for detail.
Wrench	1	Not in the figure above, refer to Figure 2.13 for detail.
Magic tape	3	Not in the figure above, refer to Figure 2.16 for detail.

2.1.1 David GNSS Receiver

David has four interfaces, refer to Figure 2.3 David GNSS Receiver.



Figure 2.3 David GNSS Receiver

The DC port of David is for power input, COMM1 port is for COM1 and CAN ports, and COMM2 port is for COM2 and USB ports, refer to chapter 5 for detailed specification.

Table 4 Definition of LEDs

LED	Colour	Description
PWR	RED	ON: the David is power on.
PV	BLUE	ON: David in Fixed solution. Blink: David in Float solution OFF: David in other position types.

Refer to section 3.2 Power on David for more details about the booting up procedure.

Refer to Chapter 5 for the specification of David receiver and the detailed definition of COMM1, COMM2 and DC ports.

2.1.2 AX3702 GNSS Antenna

AX3702 GNSS antenna is used to receive the RF signal from the satellites, and it must be connected to the David with the GNSS antenna cable in the package.



Figure 2.4 AX3702 GNSS Antenna



If an antenna from other companies is used, contact Tersus to obtain permission, or the David receiver may not work as expected.



Figure 2.5 TNC-J to SMA Cable 1.5m (GNSS antenna cable)

The GNSS antenna connector is used to install the AX3702 GNSS antenna or the High Gain Radio antenna to a tripod.



Figure 2.6 GNSS Antenna Connector

2.1.3 DC-2pin to USB Power Cable

The power cable is used to connect a power bank to the DC port of David receiver.



Figure 2.7 DC-2pin to USB Power Cable

2.1.4 COMM1-Bluetooth Module

This Bluetooth module is used to connect to the COMM1 port of David receiver.



Figure 2.8 COMM1-Bluetooth Module



The Bluetooth can only be installed to the COMM1 port of David.

The SSID of this Bluetooth module is BT420A-xxxxx_xxxxxx or BT420R-xxxxx_xxxxxx, where the first xxxxx is the last 5 digits of the Bluetooth serial number, which is printed on the Bluetooth module. No password is needed to pair with it.

2.1.5 COMM2-7pin to USB & DB9 Cable

The COMM2-7pin to USB & DB9 Cable has two functions:

Table 5 Functions of COMM2-7pin to USB & DB9 Cable

1. Connect to DB9 Male to USB Type A Male converter cable (refer to Figure 2.10) to download file saved on the internal EMMC card, refer to section Download Files from Internal EMMC Card;
2. Connect to USB Type A Female to USB (Micro +Type C) OTG cable (refer to Figure 2.11) to connect the Android phone or controller with David, refer to section 3.3.1.



Figure 2.9 COMM2-7pin to USB & DB9 Cable



The COMM2-7pin to USB & DB9 cable can only be installed into the COMM2 port of David.

2.1.6 DB9 Male to USB Type A Male converter cable

DB9 Male to USB Type A Male converter cable to connect with the COMM2-7pin to USB & DB9 Cable in Figure 2.9 of section 2.1.5.



Figure 2.10 DB9 Male to USB Type A Male converter cable

The driver for the above cable can be downloaded from

<https://www.tersus-gnss.com/software/david-receiver>

2.1.7 USB Type A Female to USB (Micro + Type C) OTG cable

This cable is to connect the device output with USB type A male connector to an android phone with micro or type C interface.



Figure 2.11 USB Type A Female to USB (Micro + Type C) OTG cable

2.1.8 Height Measure Accessory

The height measure accessory is used to determine the height of the antenna with higher accuracy.



Figure 2.12 Height Measure Accessory

2.1.9 Wrench

The wrench is used to reinforce the SMA Cable (GNSS antenna cable) to the SMA connector of David receiver.



Figure 2.13 Wrench

2.1.10 Other accessories

Bracket for rover is used to fixate all the devices on the ranging pole, and magic tape is to tie the cables to the pole, which bring convenience to field staffs.



Figure 2.14 Bracket for Rover



Figure 2.15 Ranging Pole



Figure 2.16 Magic Tape

A yellow carrying case marked with GNSS ROVER is to store all the devices and accessories of rover kit.



Figure 2.17 Carrying Case for Rover

A power bank is used to power on the David, it is not included in the package, and is to be prepared by the customers, refer to section Power on David for more details.



Figure 2.18 Power Bank

2.2 Rover Kit with 2W Radio Station

In this variant, the David receiver is connected to an external 2W radio to receive RTK corrections from a base. With an external Bluetooth or cables, the David receiver is connected to an Android phone or controller, which runs Tersus Survey software Nuwa to configure the David GNSS receiver.

The descriptions of basic components for this kit refer to section 2.1. This section introduces additional devices required for Rover Kit with 2W Radio Station.

!	Rover Kit with 2W Radio Station can work with Base Kit with 2W Radio Station or Base Kit with 30W Radio Station.
---	--

!	Rover Kit with 2W Radio Station supports Rover network mode.
---	--

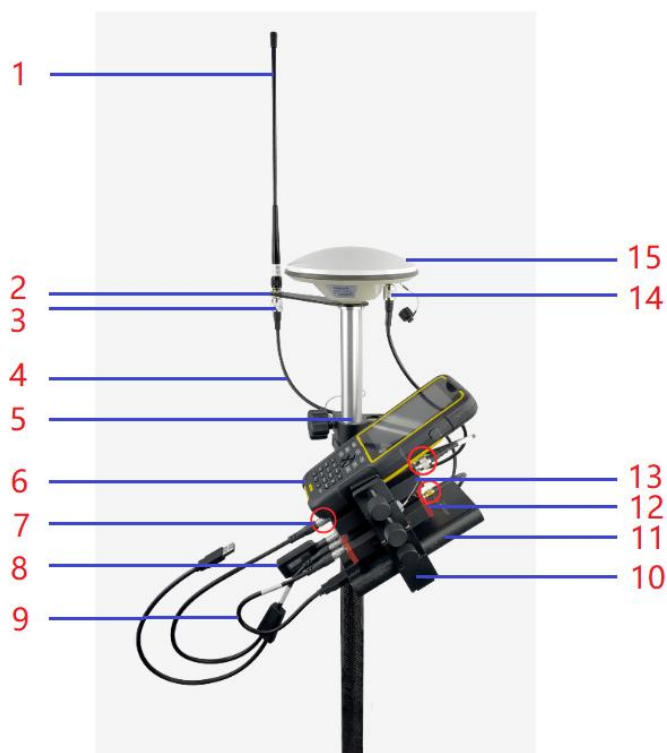

Figure 2.19 Rover Kit with 2W Radio Station

!	The power bank and controller are not included in the package. The TC20 controller is listed on https://www.ter sus-gnss.com/product/tc20-controller .
---	---

Table 6 Rover Kit with 2W Radio Station

Device Name	Quantity	Items in field photos
2W/460MHz radio antenna	1	1, refer to Figure 2.23
Bracket for 460M antenna	1	2, refer to Figure 2.24
TNC – TNC converter	1	3, refer to Figure 2.24
TNC-J to TNC-J cable 1.0M	1	4
Ranging pole	1	5
TC20 Controller	1	6
COMM2-7pin to USB & 2W-Radio-5pin cable	1	7, refer to Figure 2.22
COMM1-Bluetooth module	1	8, refer to section 2.1.4
DC-2pin to USB power cable	1	9
Bracket for rover	1	10, refer to Figure 2.15
Power bank	1	11, refer to Figure 2.18 and Power on David
David GNSS receiver	1	12
2W/460MHz radio	1	13, refer to section 2.2.1
GNSS antenna cable	1	14
AX3702 GNSS antenna	1	15
DB9 Male to USB Type A Male converter cable	1	Not in the figure above, refer to Figure 2.10
USB Type A Female to USB (Micro + Type C) OTG cable	1	Not in the figure above, refer to Figure 2.11

Height measure accessory	1	Not in the figure above, refer to Figure 2.12.
GNSS antenna connector	1	Not in the figure above, refer to section 2.1.2 for detail.
COMM2-7pin to USB & DB9 cable	1	Not in the figure above, refer to section 2.1.5 for detail.

2.2.1 2W/460MHz Radio

This radio works at 460MHz frequency, the max output power of this radio is 2W and the typical range is 5km. Refer to chapter 5 for specification details.

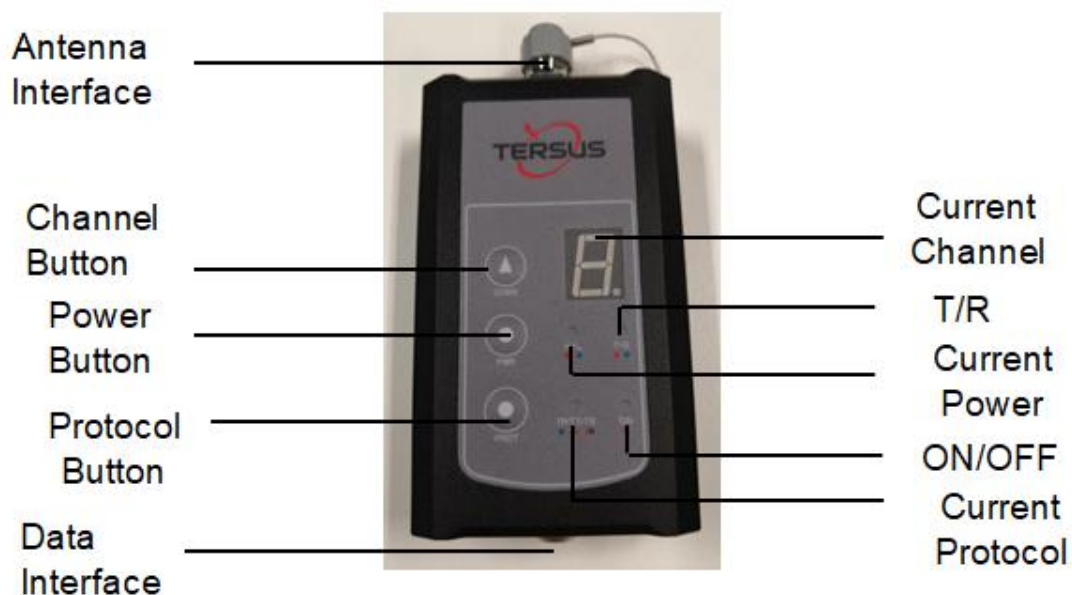

Figure 2.20 2W/460MHz Radio

Table 7 Button Description for 2W/460MHz Radio

Button	Description
Channel Button	Press once, the current channel will increase 1, channel 0~ 9 are available.

Power Button	Press once to select the output power, which can be 1W or 2W.
Protocol Button	Press protocol button to switch the protocols between TP (Transparent EOT protocol) , TT (TT450S protocol) and TS (Tersus protocol)

!	Two 2W radios must have the same protocol and the same channel frequency before they can communicate each other.
---	--

Table 8 LED Definition

LED	Description
H/L	RED: 2W output is selected, GREEN: 1W output is selected.
T/R	Blink RED: data is transmitting. Blink GREEN: data is receiving.
TP/TT/TS	GREEN: Transparent protocol is selected. RED: TT450S protocol is selected. GREEN&RED: Tersus protocol is selected.
ON	It is solid on after the power is on.

2.2.2 2W/460MHz Radio Antenna

The 2W/460MHz radio antenna is to be installed on 2W/460MHz radio and receive radio signal.



Figure 2.21 2W/460MHz radio antenna

2.2.3 COMM2-7pin to USB & 2W-Radio-5pin Cable

The COMM2-7pin to USB & 2W-Radio-5pin Cable is used to connect the David receiver to the 2W radio station & an Android phone. The length of the cable is 0.55m.



Figure 2.22 COMM2-7pin-USB & 2W-Radio-5pin Cable



COMM2-7pin to USB & 2W-Radio-5pin Cable can only be installed into the COMM2 port of David.

2.2.4 TNC-J to TNC-J Cable 1.0m (Radio Antenna Extension Cable)

The TNC-J to TNC-J cable 1.0m is the extension cable between 2W/460MHz radio and 2W/460MHz radio antenna.



Figure 2.23 TNC-J to TNC-J cable 1.0M (Radio Antenna Extension Cable)

2.2.5 Bracket for 460M antenna with TNC-TNC converter

The bracket is to fix the position of the 2W/460MHz radio antenna.



Figure 2.24 Bracket for 460M antenna with TNC – TNC converter

2.3 Base Kit Network Mode

In this variant, the David, working as a base, transmits RTK corrections to a NTRIP caster or a TCP sever. The David is connected to an Android phone with an external Bluetooth or with cables. Tersus Survey Nuwa app is installed in the Android phone to configure the David.

The descriptions of basic components for this kit refer to section 2.1. This section introduces different devices required for Base Kit Network Mode.

!	Base Kit Network Mode can work independently or work with Rover Kit Network Mode.
---	---

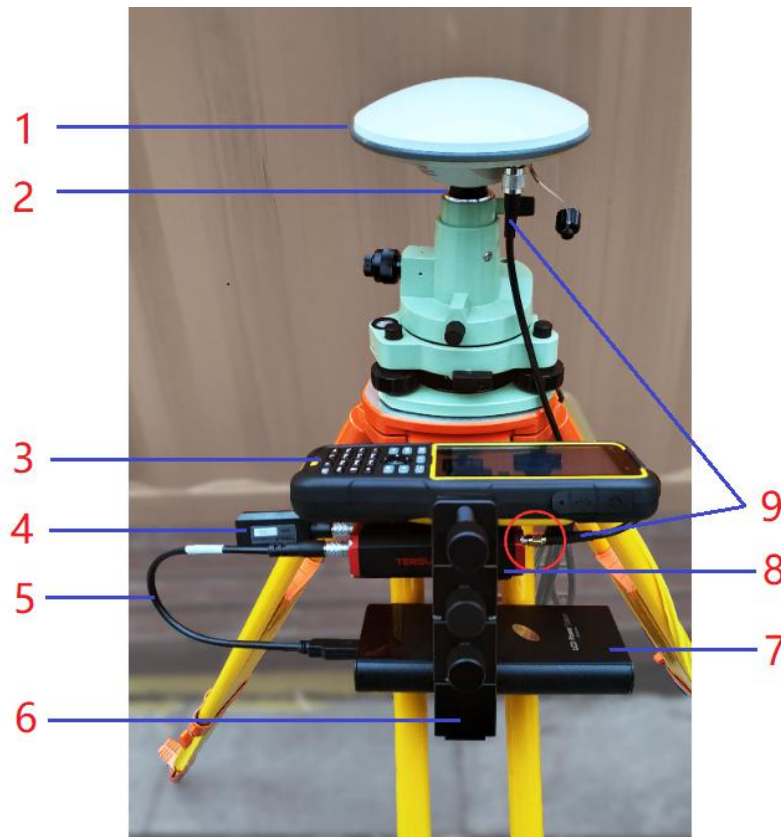

Figure 2.25 Base Kit Network Mode

!	The tripod, the power bank, the tribrach and the TC20 controller are not included in the package. The TC20 controller is listed on https://www.tersus-gnss.com/product/tc20-controller .
---	--

Table 9 Base Kit Network Mode

Device Name	Quantity	Items in field photo
AX3702 GNSS antenna	1	1
GNSS antenna connector	1	2
TC20 Controller	1	3
COMM1-Bluetooth module	1	4, refer to 2.1.4
DC-2pin to USB power cable	1	5
Bracket for base	1	6, refer to Figure 2.26
Power bank	1	7, refer to Figure 2.18 and Power on David

David GNSS receiver	1	8
GNSS antenna cable	1	9
DB9 Male to USB Type A Male converter cable	1	Not in the figure above, refer to Figure 2.10
USB Type A Female to USB (Micro + Type C) OTG cable	1	Not in the figure above, refer to Figure 2.11
Height measure accessory	1	Not in the figure above, Refer to Figure 2.12.
COMM2-7pin to USB & DB9 cable	1	Not in the figure above, refer to section 2.1.5
Tape Measure	1	Not in the figure above, Refer to Figure 2.27

2.3.1 Bracket for Base

This bracket is hooked on the tripod and all the devices in the field (an Android phone, a radio, a David and a power bank) are installed on it, which brings much convenience for field job.



Figure 2.26 Bracket for Base

2.3.2 Tape Measure

Working with height measure accessory, the tape measure gives position of a point on ground with mm-level accuracy.



Figure 2.27 Tape Measure

2.3.3 Other accessories

A yellow carrying case marked with GNSS BASE is to store all the devices and accessories of base kit.



Figure 2.28 Carrying Case for Base

2.4 Base Kit with 2W Radio Station

In this variant, the David, working as a base, transmits RTK corrections to an external 2W radio. The David is connected to an Android phone with cables or with the Bluetooth module. Tersus Survey Nuwa app is installed in the Android phone to configure the David.

The descriptions of basic components for this kit refer to section 2.1. This section introduces different devices required for Base Kit with 2W Radio Station.

!	Base Kit with 2W Radio Station can work with Rover Kit with 2W Radio Station only.
---	--

!	Base Kit with 2W Radio Station can support Base network mode.
---	---

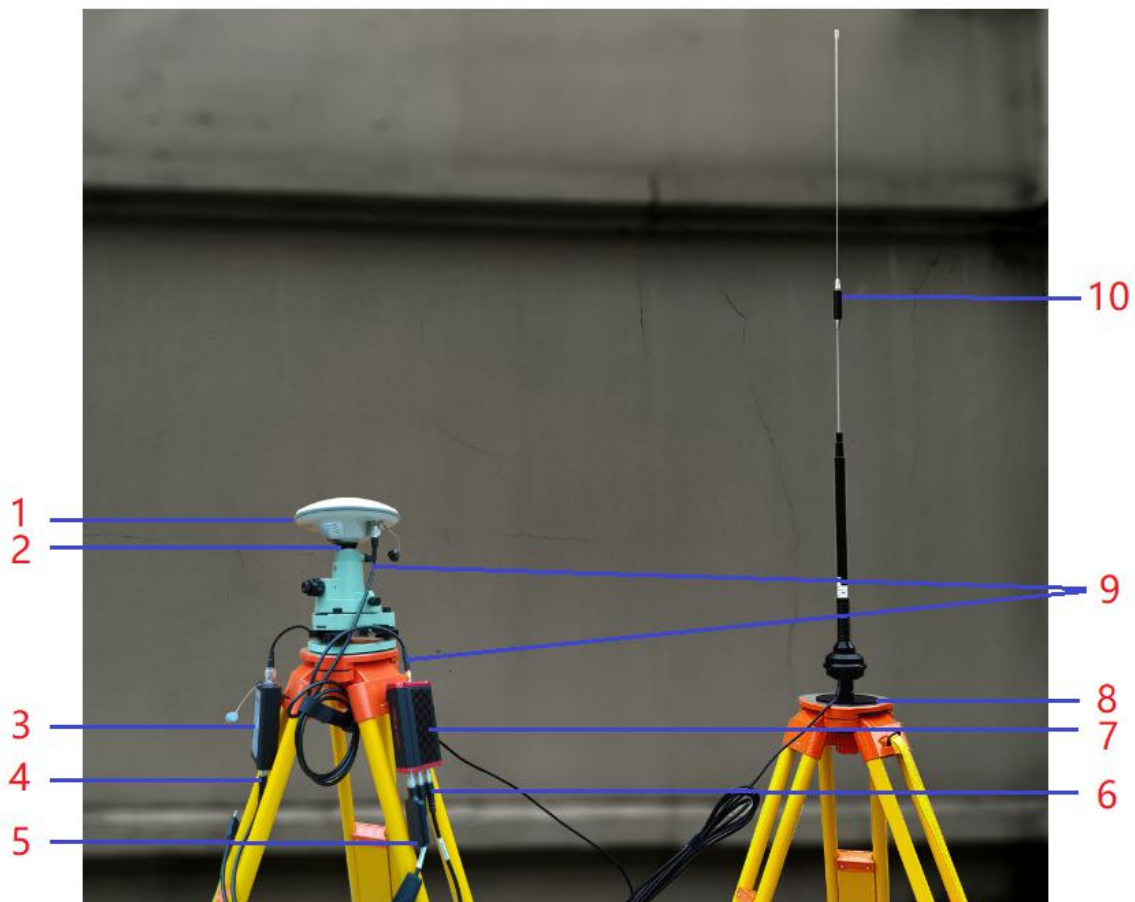

Figure 2.29 Base Kit with 2W Radio

!	The two tripods and the tribrach in Figure 2.29 are not included in the package.
---	--

Table 10 Base Kit with 2W Radio Station

Device Name	Quantity	Items in field photo
AX3702 GNSS antenna	1	1, refer to section 2.1.2
GNSS antenna connector	2	2, refer to section 2.1.2
2W/460MHz radio	1	3, refer to section 2.2.1
COMM2-7pin to USB & 2W-Radio-5pin Cable	1	4, refer to Figure 2.22
COMM1-Bluetooth module	1	5, refer to section 2.1.4
DC-2pin to Bullet DC Power cable	1	6, refer to Figure 2.30
David GNSS receiver	1	7, refer to section 2.1.1
Metal plate for radio antenna	1	8, refer to Figure 2.36
GNSS antenna cable	1	9, refer to section 2.1.2
High Gain Radio Antenna	1	10, refer to Figure 2.35
Telescopic pole for radio antenna	1	Not in the figure above, refer to Figure 2.36
Height measure accessory	1	Not in the figure, refer to section 2.1.8
Wrench	1	Not in the figure, refer to section 2.1.9
DB9 Male to USB Type A Male converter cable	1	Not in the figure above, refer to Figure 2.10
USB Type A Female to USB (Micro + Type C) OTG cable	1	Not in the figure, refer to Figure 2.11
Bullet-DC to Alligator Clips	1	Not in the figure, refer to Figure 2.31
DC-2pin to USB power cable	1	Not in the figure refer to Figure 2.7
Tape measure	1	Refer to Figure 2.27
Hook and screws for 2W radio	1	Refer to Figure 2.33
Hook and screws for David	1	Refer to Figure 2.32
Bracket for Mobile	1	Refer to Figure 2.34
COMM2-7pin to USB & DB9 Cable	1	Refer to section 2.1.5

2.4.1 DC-2pin to Bullet-DC Power cable

The DC-2pin of this cable is to connect to the DC port of David receiver, the Bullet-DC is to connect with Bullet-DC to Alligator Clips in the figure below.



Figure 2.30 DC-2pin to Bullet DC Power Cable

2.4.2 Bullet-DC to Alligator Clip

The Bullet-DC of this cable is to connect to the Bullet-DC of the cable in the figure above. The alligator clips of this cable is to connect to the positive and negative of external power supply.



Figure 2.31 Bullet-DC to Alligator Clips

2.4.3 High Gain Radio Antenna

The gain of this high gain radio antenna is 5.5 dBi and the working frequency range is 450 – 470 MHz.



Figure 2.32 High Gain Radio Antenna

2.4.4 Metal plate for radio antenna

This metal plate is used to fixate the radio antenna to the tripod.



Figure 2.33 Metal plate for radio antenna

2.4.5 Telescopic pole for radio antenna

The telescopic pole is used to extend the height for radio antenna.



Figure 2.34 Telescopic pole for radio antenna

2.4.6 Hook and Screws for 2W Radio

The hook and screws below are attached to 2W radio for hanging on the tripod.



Figure 2.35 Hook and Screws for 2W Radio (attached to 2W radio)

2.4.7 Hook and Screws for David

The hook and screws below are attached to David receiver for hanging on the tripod.



Figure 2.36 Hook and Screws for David (attached to David)

2.4.8 Bracket for Mobile

The bracket below is for fixating mobile terminal onto the tripod.



Figure 2.37 Bracket for Mobile

2.4.9 Other accessories

The tool bag below is to store high gain radio antenna and telescopic pole for radio antenna.



Figure 2.38 Tool bag

2.5 Base Kit with 30W Radio Station

In this variant, the David, working as a base, transmits RTK corrections to an external 30W radio. The David is connected to an Android phone with cables or with the Bluetooth module. Tersus Survey Nuwa app is installed in the Android phone to configure the David.

The descriptions of basic components for this kit refer to section 2.1 and 2.4.

This section introduces different devices required for Base Kit with 30W Radio Station.

!	Base Kit with 30W Radio Station can work with Rover Kit with 2W Radio Station only.
---	---

!	Base Kit with 30W Radio Station can support Base network mode.
---	--

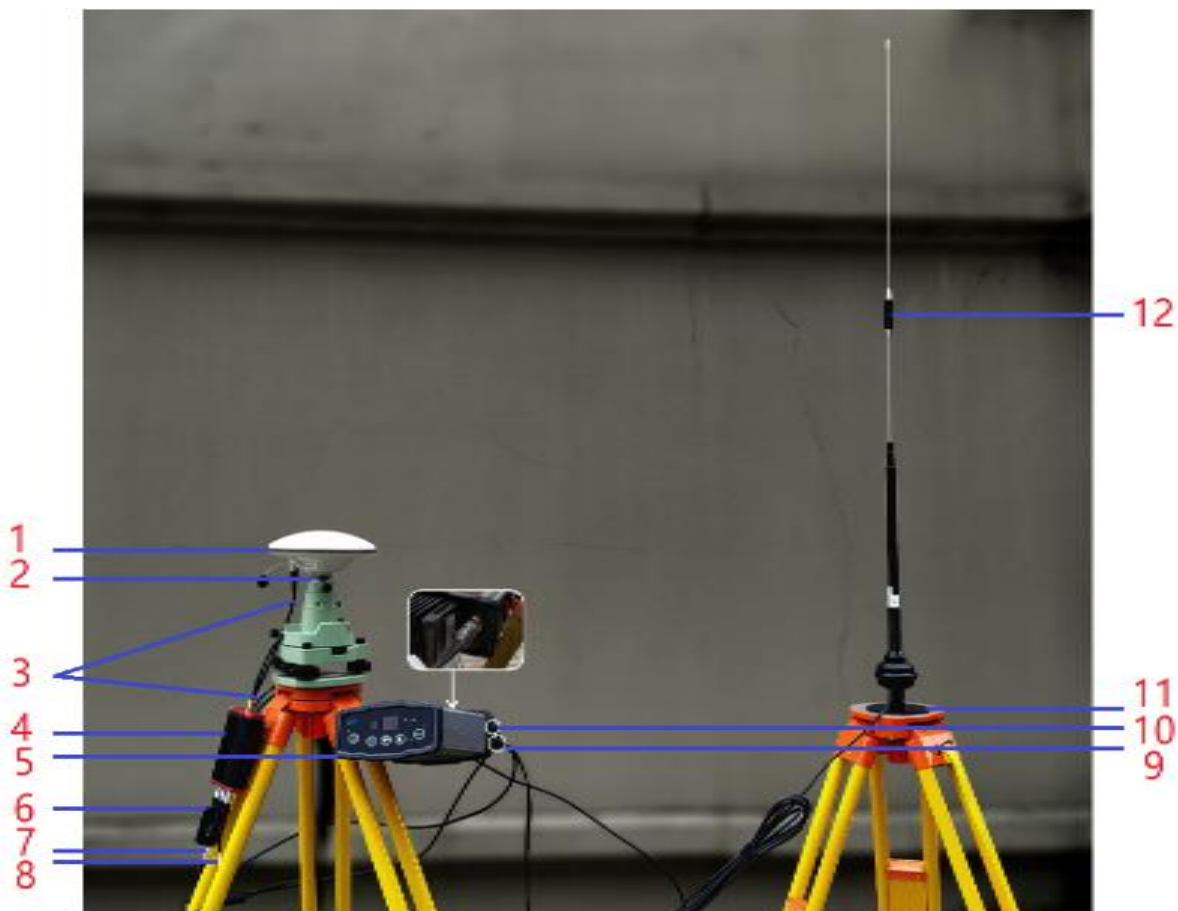

Figure 2.39 Base Kit with 30W Radio

!	The two tripods and the tribrach in Figure 2.39 are not included in the package.
---	--

Table 9 Base Kit with 30W Radio Station

Device Name	Quantity	Items in field photos
AX3702 GNSS antenna	1	1, refer to section 2.1.2
GNSS antenna connector	2	2, refer to section 2.1.2
GNSS antenna cable	1	3, refer to section 2.1.2
David GNSS receiver	1	4, refer to section 2.1.1
30W radio	1	5
COMM1-Bluetooth module	1	6, refer to section 2.1.4
COMM2-7pin to USB & 30W-Radio-5pin Cable	1	7 & 10, refer to Figure 2.42
DC-2pin & 30W-Radio-DC-2pin to Bullet-DC	1	8 & 9, refer to Figure 2.41
Metal plate for radio antenna	1	11, refer to Figure 2.36
High Gain Radio Antenna	1	12, refer to Figure 2.35
Bullet-DC to Alligator Clips	1	refer to Figure 2.31
Telescopic pole for radio antenna	1	refer to Figure 2.34
DB9 Male to USB Type A Male converter cable	1	Not in the figure, refer to Figure 2.10.
USB Type A Female to USB (Micro + Type C) OTG cable	1	Not in the figure, refer to Figure 2.11
Height measure accessory	1	Not in the figure, refer to Figure 2.12.
DC-2pin to USB power cable	1	Not in the figure, refer to Figure 2.7
COMM2-7pin to USB & DB9 cable	1	Not in the figure, refer to section 2.1.5
Wrench	1	Not in the figure, refer to section 2.1.9
Hook and screws for David	1	Refer to Figure 2.33
Bracket for mobile	1	Refer to Figure 2.34
Tape measure	1	Not in the figure, Refer to Figure 2.27

2.3.1 30W Radio

The 30W radio is used when a longer baseline is required. The typical range is 15km, refer to chapter 5 for detailed specification.



Figure 2.40 30W Radio

Table 10 and Table 11 present the definition of the control buttons and the LED, respectively.

Table 10 Definition of the Control Buttons

Buttons	Function
ON/OFF	Press 1s to power on the radio Press 2s to power off the radio
ARROW UP/DOWN	To select the channel
RF PWR	Press 1s to select the RF output power

Table 11 Definition of LEDs

LEDs	Description
ON/OFF	RED: the input voltage is normal. Blink RED: the input voltage is out of the min limits.
TX/RX	Blink RED: the radio is transmitting. Blink BLUE if the radio is receiving.
Channel	Shows the current channel

BAT CAP	Shows the battery left.
RF PWR	Shows the current RF output power: OFF: 30W BLUE: 20W RED: 10W RED+BLUE: 5W

2.3.2 DC-2pin & 30W-Radio-DC-2pin to Bullet-DC

The DC-2pin of this cable is to connect to the DC port of David receiver, the 30W-Radio-DC-2pin of this cable is to connect to the DC port of 30W radio, and the Bullet-DC is to connect with Bullet-DC to Alligator Clips in Figure 2.31.



Figure 2.41 DC-2pin & 30W-Radio-DC-2pin to Bullet-DC

2.3.3 COMM2-7pin to USB & 30W-Radio-5pin Cable

The COMM2-7pin to USB & 30W-Radio-5pin Cable is used to connect the David receiver to the 30W radio station & an Android phone. The length of the cable is 1.0m.



Figure 2.42 COMM2-7pin to USB & 30W-Radio-5pin Cable

3. General operation

The general operation of David is related to the Tersus Survey Nuwa application, which is introduced in the software manual. This chapter describes how to do the hardware connection only.

	<ul style="list-style-type: none"> ■ To make David work properly, the customer needs to provide qualified power to David (refer to chapter 5 for requirement), power to the 30W radio (if 30W radio is used, refer to chapter 5 for details) and an Android phone to run Tersus Survey Nuwa app. ■ David may be damaged if devices from other companies are used to replace the ones in the package. And the warranty may be void if this situation happens.
---	--

3.1 Install the GNSS antenna

Connect the AX3702 GNSS antenna to David with the GNSS antenna cable. Please ensure the connectivity is reliable.

	<p>The ideal place for a GNSS antenna is a point without GNSS signals blockage from horizon to horizon and is far away from any potential interfering source. The specific distance depends on type of the interfering source.</p>
---	--

3.2 Power on David

The input voltage to David is 5 – 12 V DC.

	<p>It's highly recommended to power on David with an USB port from a power bank (5V DC and 2A or more current output) with the power cable in the package, or the David may not boot up successfully.</p>
---	---



After power on, the PV LED is ON for 3 to 5 seconds, then it turns OFF, which means the David is booting up successfully.

If the PV LED is NOT acting as the above steps, it means the David is NOT booting up successfully.



If other power instead of a power bank is used to power on David, the customer needs to prepare a power cable and take all the risks involved.

The working time of David depends on the capacity of the power bank.

The following formula can be used to estimate the operating time (assume the output voltage is 5V):

If no radio or an external 30W radio is connected to the David:

$$\text{Time (hour)} = \text{capacity (mA.Hour)} * 5 / (1000 * 3.2)$$

If 1W radio is connected to the David:

$$\text{Time (hour)} = \text{capacity (mA.Hour)} * 5 / (1000 * (3.0+3.2))$$

If 2W radio is connected to the David:

$$\text{Time (hour)} = \text{capacity (mA.Hour)} * 5 / (1000 * (6.5+3.2))$$



1) It is highly recommended the capacity of the power bank is 10,000 mAh or more.

2) The working time above are theoretical values at 25°C temperature for reference only. However, according to experience, the real working time may be 2/3 or less of above values.

3.3 Communication between Android phone and David

David can communicate with an Android phone through wires or Bluetooth.

3.3.1 Wires connection

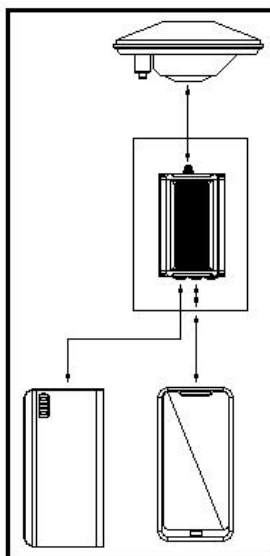

Figure 3.1 Outline of Android phone to David with Wires

!	<p>Two cables are used to connect the COMM2 port of David to the USB port of the Android phone which are:</p> <ul style="list-style-type: none"> ● COMM2-7pin to USB & DB9 cable or COMM2-7pin to USB & 2W-Radio-5pin cable or COMM2-7pin to USB & 30W-Radio-5pin cable. ● USB Type A Female to USB (Micro + Type C) OTG cable
---	--

!	<p>The Android phone is NOT charging when it's connected to David with wires.</p>
---	---

The detailed steps are described as follows:

1. Connect the COMM2 port of David to the USB port of the Android phone

using the cables mentioned above.

2. Connect the AX3702 GNSS antenna to David with the GNSS antenna cable.
3. Power on the David receiver with a power bank.
4. Run Nuwa, click [Device] -> [Connect].
5. Select [USB] in the option list of Connect Type.
6. Click [Connect Config] to update accordingly.
7. Click [Connect] to enable the communication with David.

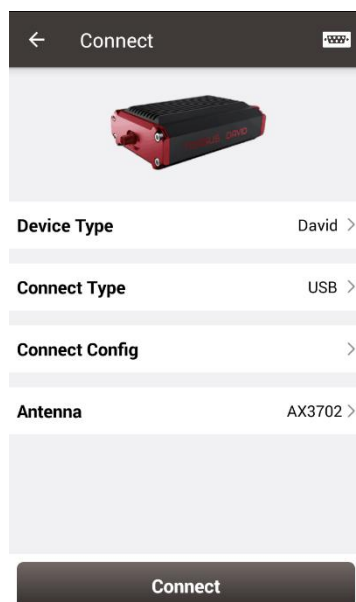

Figure 3.2 Connect using USB cable

3.3.2 External Bluetooth Connection

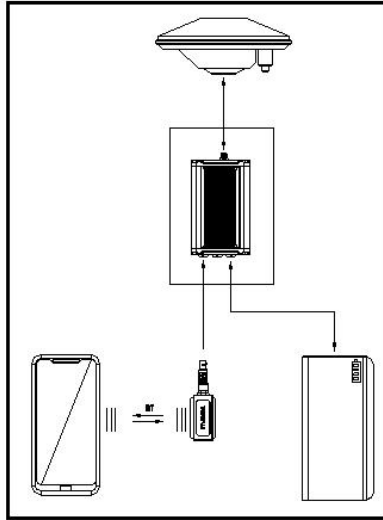

Figure 3.3 Outline of Android phone to David with Bluetooth



All the five variants support connection with Bluetooth and cables.

The detailed steps are described as follows:

1. Install the Bluetooth module to the COMM1 port of David.
2. Connect the AX3702 GNSS antenna to David with the GNSS antenna cable.
3. Power on the David receiver with a power bank
4. Run Nuwa app, click [Device] -> [Connect].
5. Select [Bluetooth] in the option list of Connect Type.
6. Click [Connect Config] -> [Search]. The SSID is BT420A-xxxxx_xxxxxx or BT420R-xxxxx_xxxxxx. No password is needed to pair with it
7. Click [Connect] to enable the communication with David.

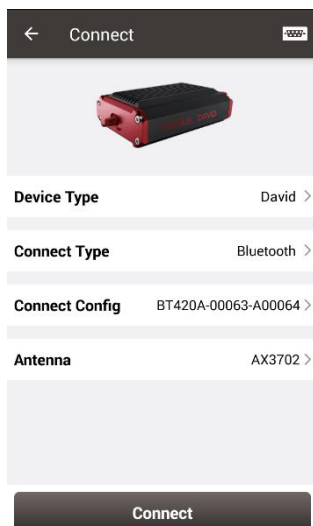

Figure 3.4 Connect using Bluetooth

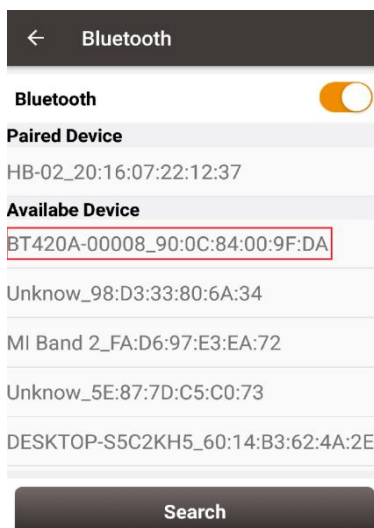

Figure 3.5 Search Bluetooth device

!	A Bluetooth device can be removed from the Available Device list by pressing it for a few seconds.
---	--

3.4 Firmware Update

3.4.1 Hardware Connection

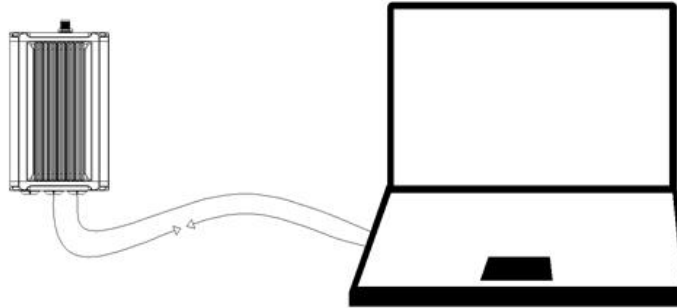

Figure 3.6 Outline of David connected to a Computer

The hardware connection for firmware update is described as follows:

1. Connect the COMM2 port of the **COMM2-7pin to USB & DB9 cable** to the COMM2 port of the David receiver.
2. Connect the DB9 port of the **DB9 Male to USB Type A Male converter cable** to the DB9 port of the **COMM2-7pin to USB & DB9 cable**.
3. Connect the USB port of the **DB9 Male to USB Type A Male converter cable** to the USB port of the computer.
4. Connect the DC-2pin port of the **DC-2pin to USB Power Cable** to the DC port of the David receiver.
5. Connect the USB port of the **DC-2pin to USB Power Cable** to a USB port of a computer or an external power bank with 5V supply,

3.4.2 USB to Serial COMM Port driver

After completing the hardware connection, David receiver is powered on automatically when the power cable is connected to a power source.

Simultaneously the computer recognizes the COM port in the Computer Management as shown in Figure 3.7.

If the COM port is not recognized, right click the port name and click [Update Driver Software...] which is shown in Figure 3.8. In the pop-up window as shown in Figure 3.9, select [Search automatically for updated driver software] if the computer is connected on internet. Windows search and install the driver software automatically.

In the situations of automatic search failed and the computer not connecting to the internet, select [Browse my computer for driver software] and browse the location of the driver software which is downloaded from Tersus website <https://www.tersus-gnss.com/software>.

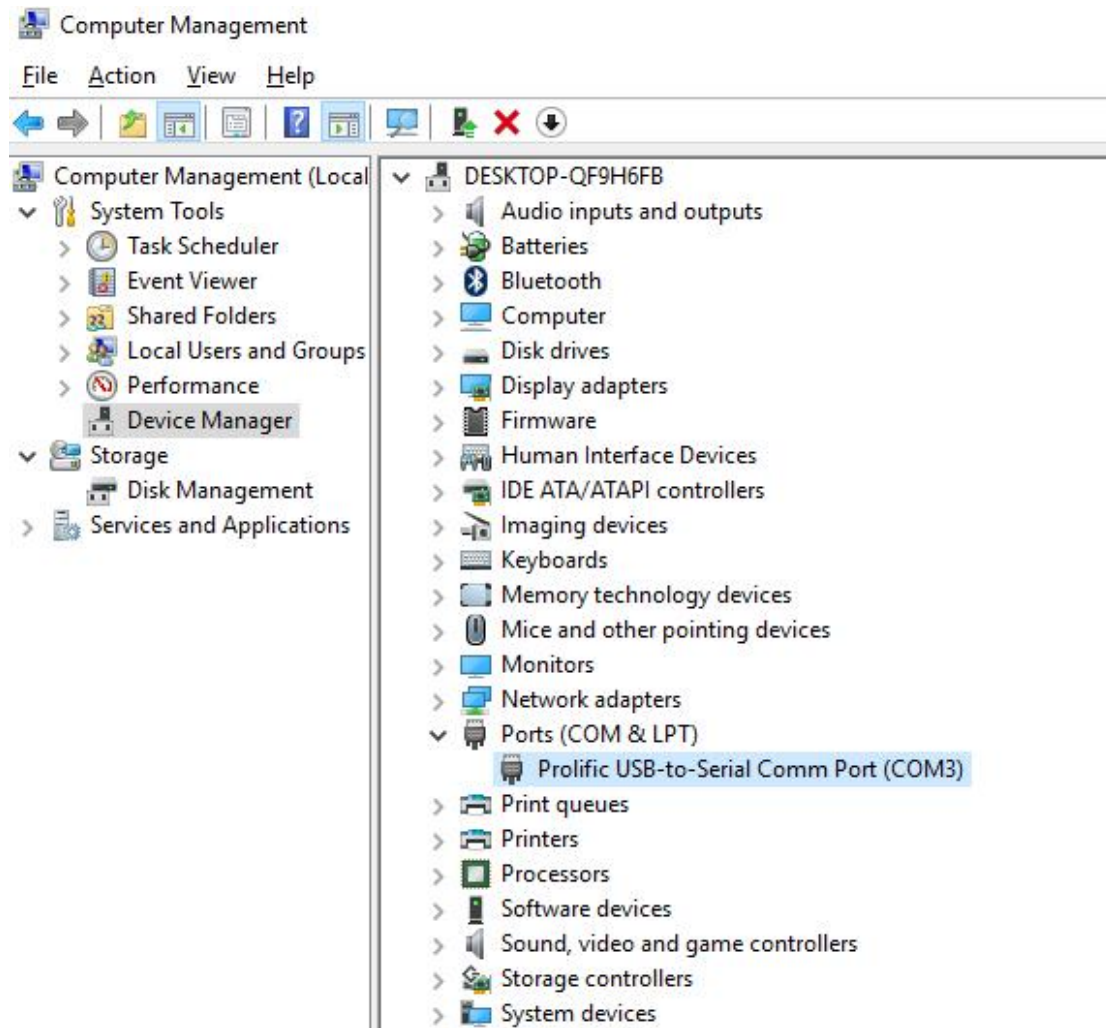

Figure 3.7 COM port is recognized by the computer in the Computer Management

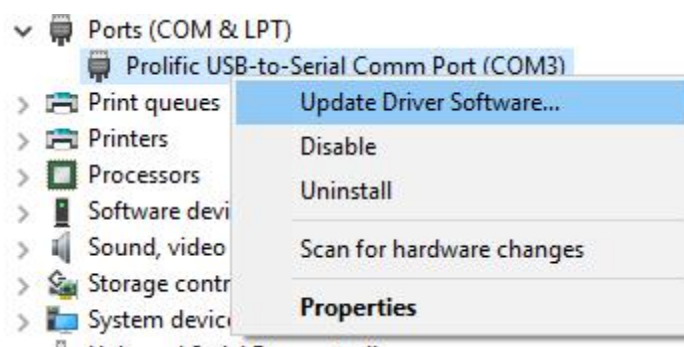

Figure 3.8 Update Driver Software manually

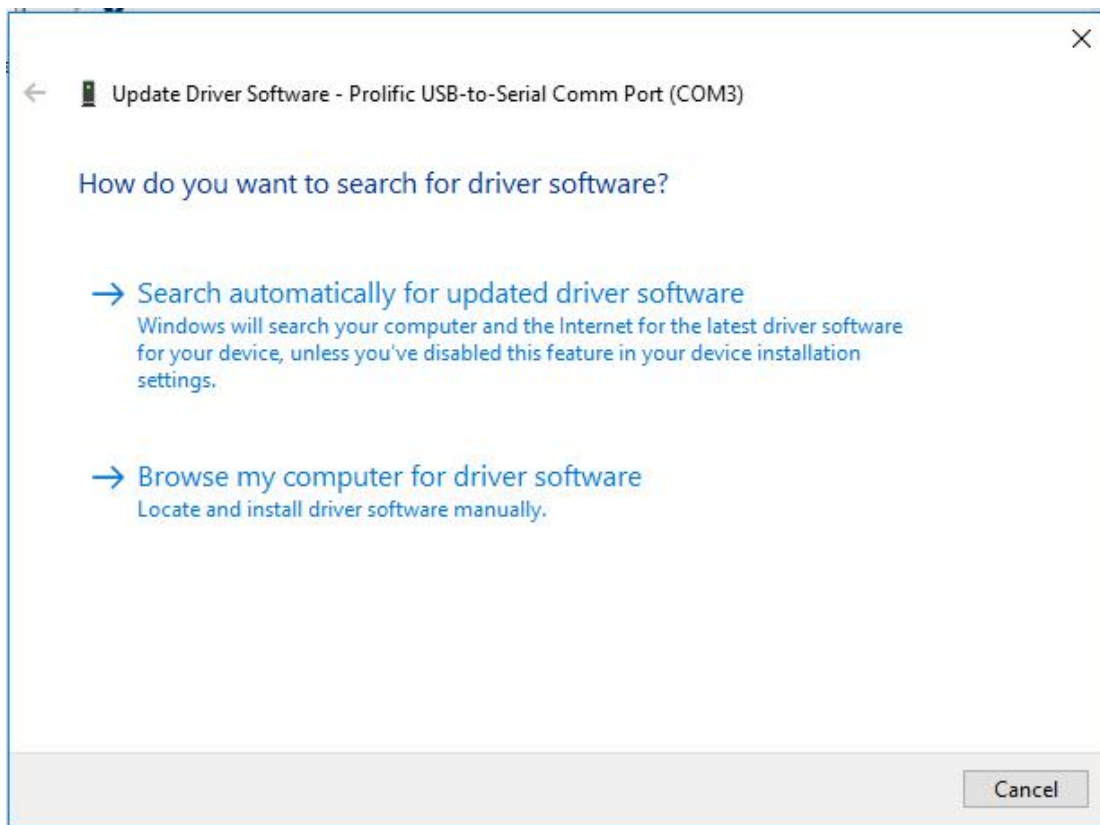

Figure 3.9 Two methods of searching for driver software

3.4.3 Firmware Update

The updated firmware is released and available for downloading on Tersus web site <https://www.tersus-gnss.com/software>, or it can be obtained from Tersus technical support.

The firmware version of the current David receiver can be examined in Tersus GNSS Center by typing 'LOG VERSION' in the command area, and in Nuwa app by clicking [Device] -> [Device Info]. The detailed steps for firmware update are as follows.

1. Use TersusUpdate software in the Tersus Tool Suite for the firmware update. Double click the icon on the desktop to launch the software.



Figure 3.10 PC software icons on desktop

2. In the TERSUSUpdate interface, the software recognizes the serial port and scans the baud rate automatically. Select the Port which is connected to David receiver, browse the location for the updated firmware file, and click [Next] to enter the next step.

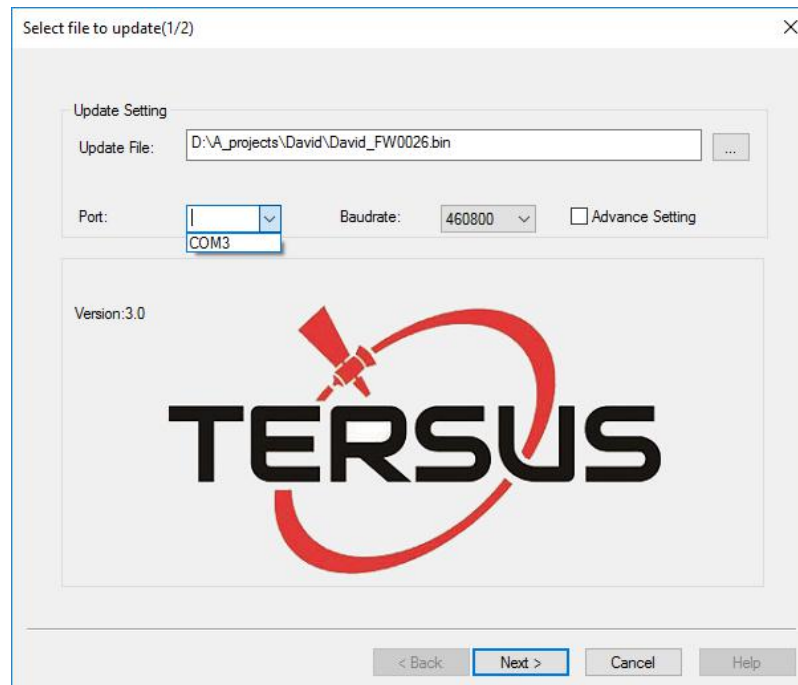

Figure 3.11 Firmware Settings in TERSUSUpdate software

3. The firmware is updating in progress as shown in Figure 3.12 below. Do not power off the receiver during the verification and update progress.

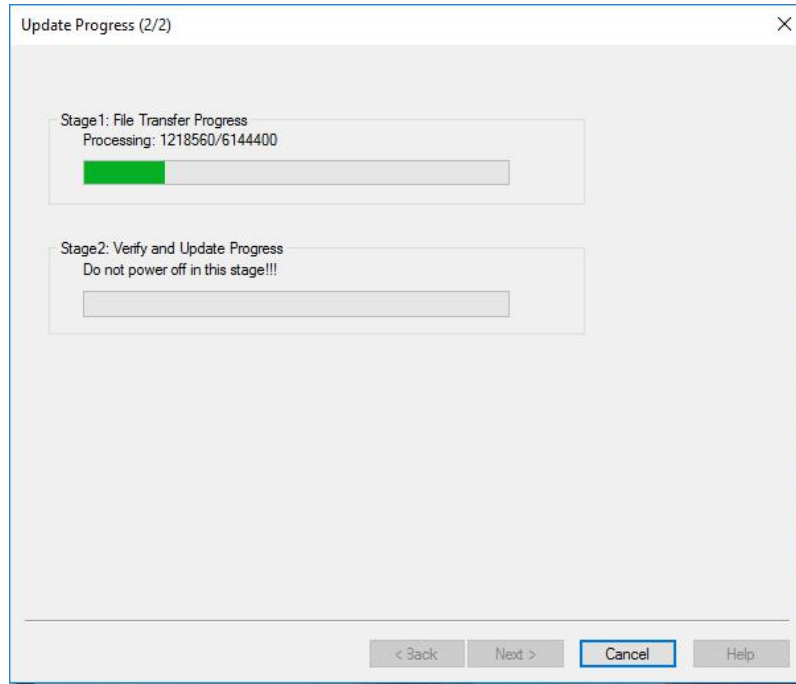

Figure 3.12 Update Progress of the firmware update

4. The update is successful is shown in the figure below.

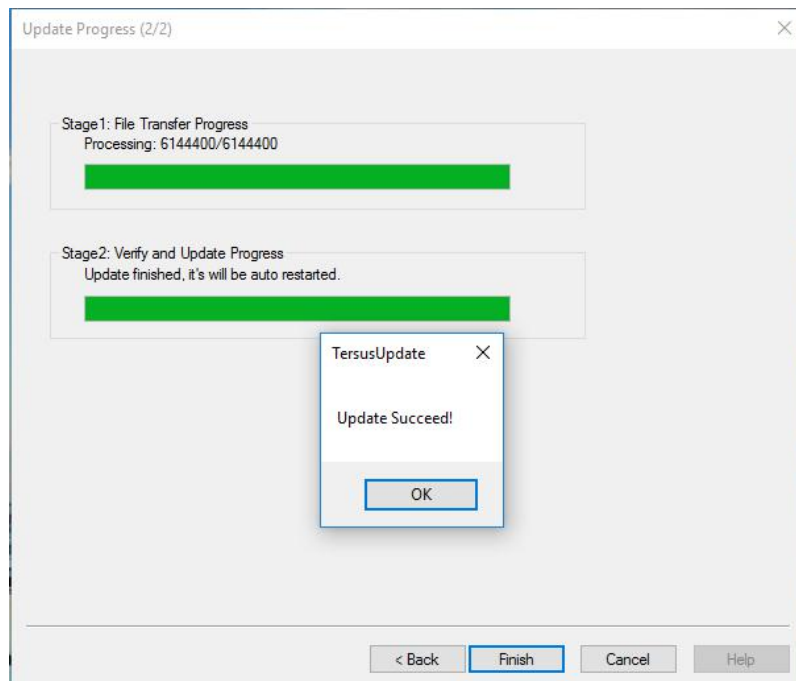

Figure 3.13 Firmware update successful interface

5. Click [OK] and [Finish] to close the firmware update window. The receiver would reset automatically.

6. After the David receiver is boot up, the current firmware version can be checked in Tersus GNSS Center by typing 'LOG VERSION' in the command area, and in Nuwa app by clicking [Device] -> [Device Info].

Note:

There is Advance Setting option in the firmware update window, if a David receiver

- cannot boot up successfully, or
 - cannot work well after boot up, or
 - cannot finish firmware update successfully according to the above steps,
- [Advance Setting] option can be selected to start FW update again.

If the [Advance Setting] is checked, select [Manual Hardware Reset] in the pop-up window and click [OK]. Click [Next] in the previous interface, power off the David receiver, wait for five seconds and power on the receiver again.

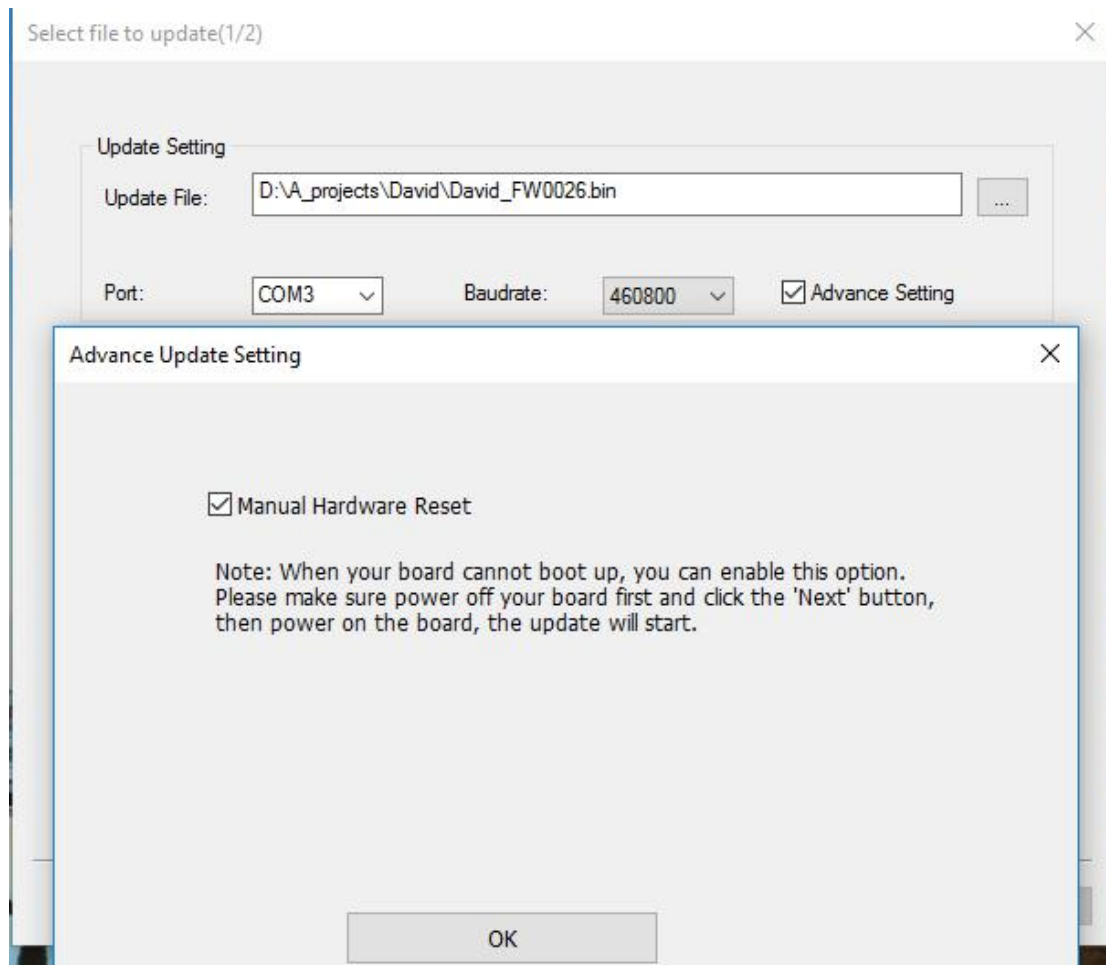

Figure 3.14 Advance Setting for firmware update

After firmware update is finished, power off the receiver, wait for five seconds and power on the receiver again.



This option is for experienced users. If you're not sure whether it should be selected, contact Tersus technical support before selecting this option.

3.5 Auth Code

An auth code is used to determine the features and valid time for a David receiver. If the auth code is expired, the receiver will not work.

To get a new auth code to register, check information as follows:

1. Follow the connection in Figure 3.6 and the detailed steps in section 3.4.1 to create communication between a David receiver and Tersus GNSS Center.
2. Input 'LOG VERSION' (get the version info) and 'LOG AUTHLST' (get the auth list info) in the command window of Tersus GNSS Center, and send the output info to Tersus support. If the output auth code is approved by Tersus, a reg.txt file would be provided to customer. In the reg.txt file there is auth code, copy the auth code and use command to type in the text console window of Tersus GNSS Center to complete the registration.
3. Or connect the David with Nuwa app, click [Device] -> [Device Info] to get below interface as shown in Figure 3.15. Ensure the reg.txt file is copied and pasted to the FilePath folder, the auth code is shown in the window below, click [Register] to complete the registration.

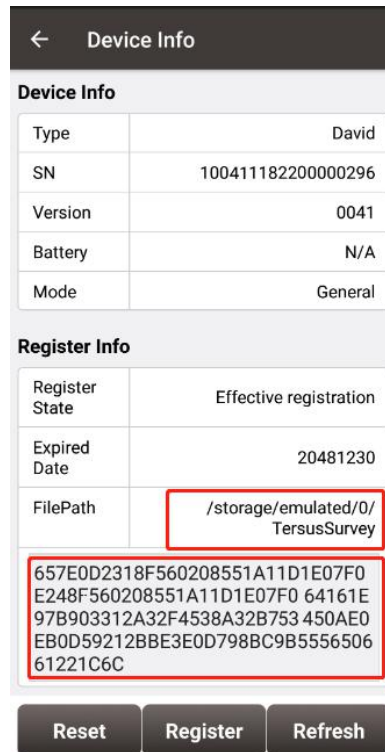

Figure 3.15 Device Information interface on Nuwa app

3.6 Download Files from Internal EMMC Card

The files saved on David's internal EMMC card can be downloaded to the computer via a serial port or an USB port (recommended and used in the following example).

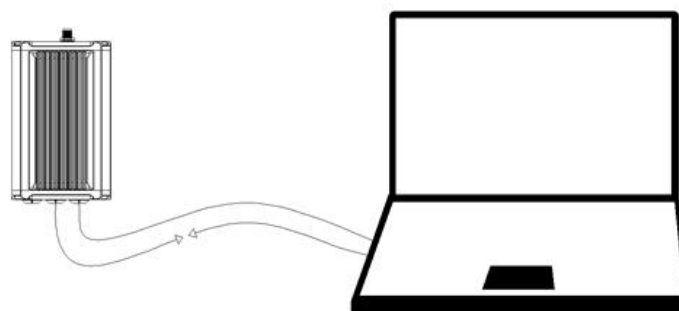

Figure 3.16 Download file from EMMC card

The detailed steps of downloading files from EMMC card are as follows:

1. Connect the COMM2 port of David receiver to the USB port of a computer using COMM2-7pin to USB & DB9 cable or COMM2-7pin to USB & 2W-Radio-5pin cable or COMM2-7pin to USB & 30W-Radio-5pin cable.
2. Power on the David receiver.
3. Run the TersusDownload software on the computer.

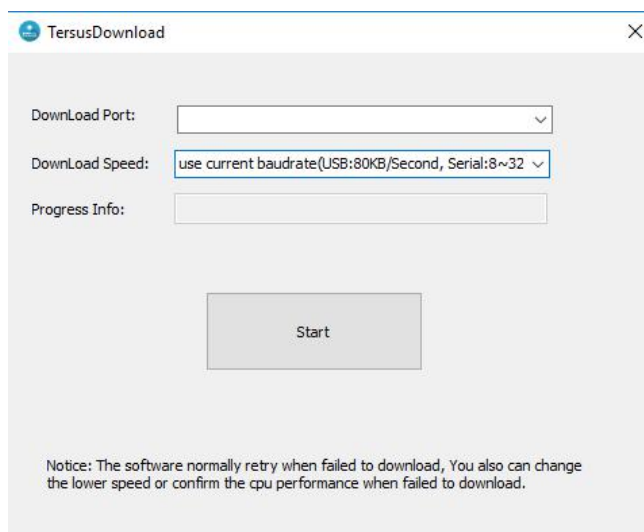

Figure 3.17 File download using TersusDownload

4. Select the serial port to communicate with the David receiver.

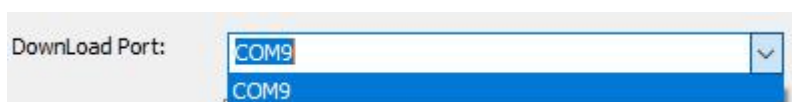

Figure 3.18 Select serial port for Download Port

5. Select the download speed (using USB port for example). Select baud rate if a serial port is used to download the files.

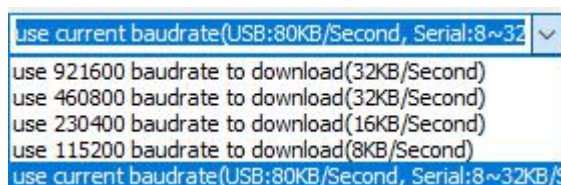

Figure 3.19 Select download speed

- After completing the above two steps, click [Start] and it pops out below window. Select the DownloadPath to store the incoming files and check the files to be downloaded, click [Download] to start downloading.

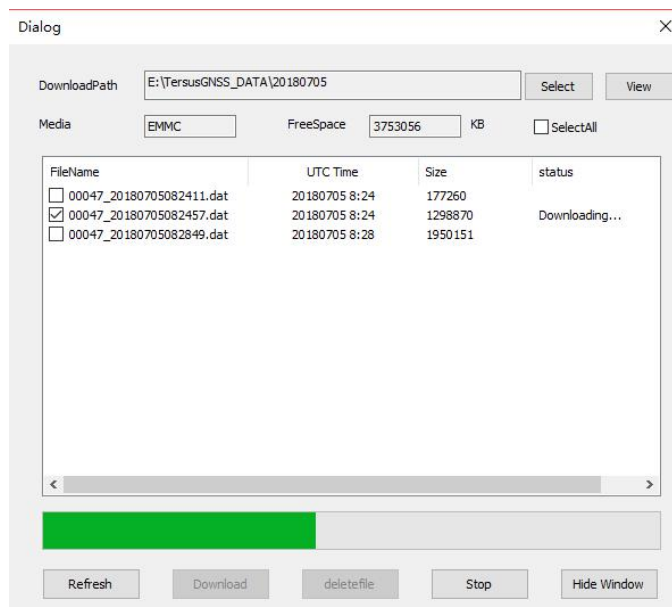

Figure 3.20 File downloading in process



The downloading rate is about 2MB/min, the downloading time can be estimated based on it.

3.7 Input command directly to the GNSS board

Users can input commands directly to the BX306 board inside David to configure the receiver, the steps are described as below.

- Follow the instructions in section 3.3.1 or section 3.3.2 to connect the android phone to the David receiver.
- Run Nuwa app, click [Device] -> [Data Terminal].
- Users can input commands in the command window according to the Log & Command document.
- Click [Send] to input the command to the BX306 board.

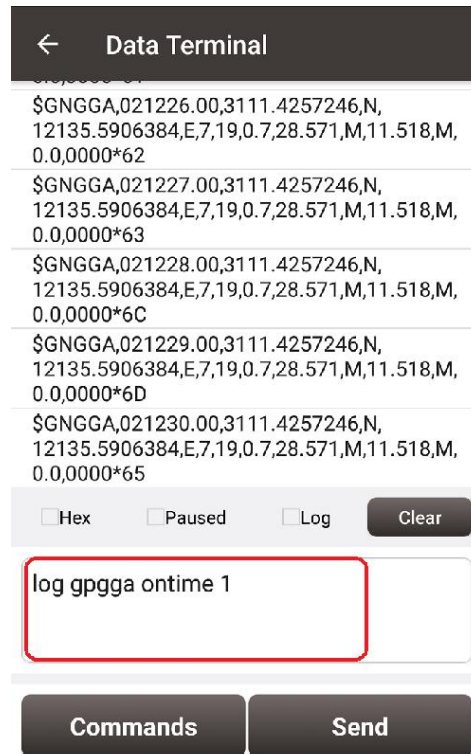





Figure 3.21 Input command in Data Terminal on Nuwa app

4. Introduction of Nuwa

Nuwa is the Tersus survey app, which runs in an Android phone. All the configuration commands for David are input of Nuwa, and all the operations of David are completed on Nuwa. Four menu tabs are provided in the main interface which are Project, Device, Survey and Tools. Refer to the user manual for Nuwa app for details.



Figure 4.1 Booting up page of Nuwa app

	Tersus Survey Nuwa app supports Android system; currently the IOS version is not available.
	The minimal requirements for Android phone: <ol style="list-style-type: none"> 1) The phone must support OTG, otherwise, it cannot be connected to David with cables, but only with Bluetooth. 2) The Android system is 6.0 or later version.
	1) There are lots of Android versions in market, therefore an Android phone meeting the minimal requirements above may still have problems to run Nuwa app.

	<p>2) Nuwa is tested with: Huawei Mate 7/Honor 7/9, Oppo A57, Vivo X9, Samsung C7 Pro and Tersus TC20 Controller.</p> <p>3) It is highly recommended that an Android phone with better hardware performance than those above is used to run Nuwa app.</p>
--	---

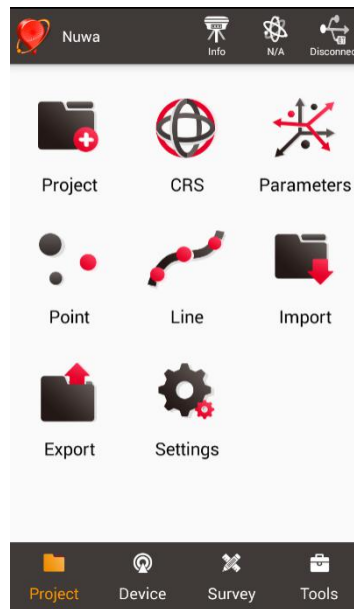

Figure 4.2 Nuwa app interface 1 – Project

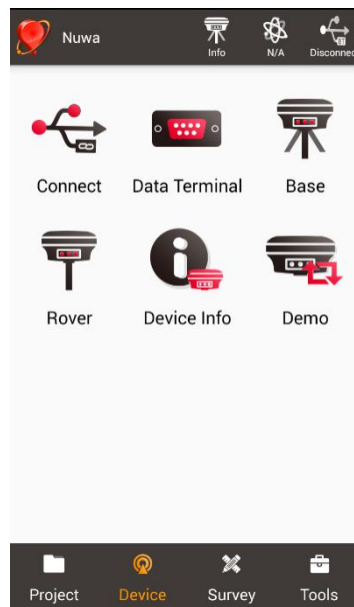

Figure 4.3 Nuwa app interface 2 – Device

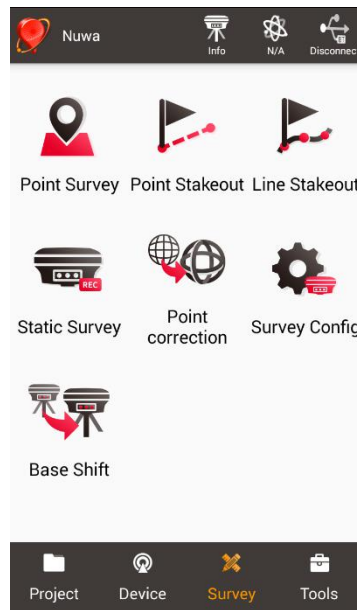

Figure 4.4 Nuwa app interface 3 – Survey

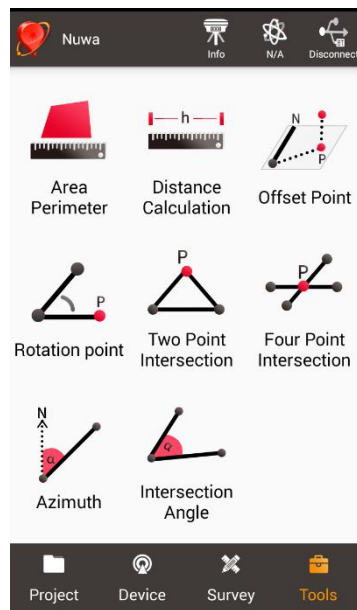

Figure 4.5 Nuwa app interface 4 – Tools

5. Specification

5.1 David Receiver

Table 12 David GNSS Performance

GNSS Performance		
Position Accuracy	Single positioning	1.5m RMS (Horizontal)
		3.0m RMC (Vertical)
	RTK Positioning	10mm+1ppm (Horizontal)
		15mm+1ppm (Vertical)
	Static post processing	3mm+0.5ppm (Horizontal)
		5mm+0.5ppm (Vertical)
GNSS Channels	384	
Time to First Fix	Cold Start: <50s Warm Start: <30s	
Reacquisition	0.5s L1 (typical) 1.0s L2 (typical)	
Data Rate	Measurements	20Hz
	Position	5Hz
Time Accuracy	20ns RMS	
Velocity Accuracy	0.03m/s RMS	
Measurement Precision	C/A Code	10cm
	P Code(zenith direction)	10cm
	Carrier Phase (zenith direction)	1mm
Physical Description		
Dimension	104*65*31 mm (David only)	
Weight	250g (David only)	

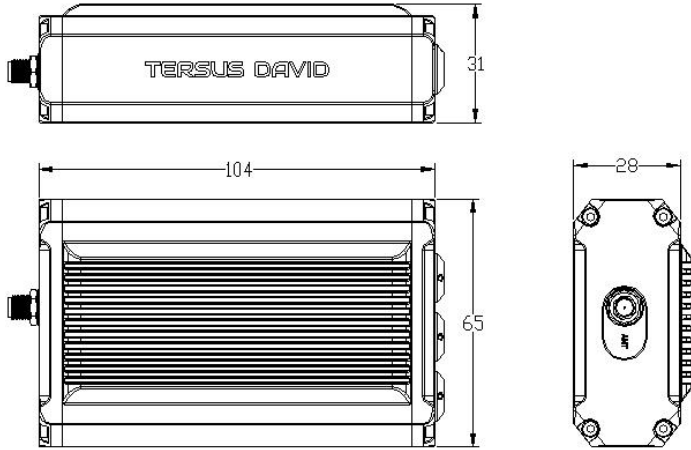
Mechanical Drawing	
	
Environmental	
Operating Temperature	-40°C to +85°C
Storage Temperature	-55°C to +95°C
Humidity	MIL-STD-810G, Method 507.5 Procedure II (95%)
Random Vibration	MIL-STD 810G Method 514.6, Category 24 (7.7 g RMS)
Sinusoidal Vibration	IEC 60068-2-6 (5 g)
Bump	ISO 9022-31-06 (25 g)
Shock	Operating: MIL-STD-810G, Method 516.6, Procedure I (40 g) Non-operating: MIL-STD-810G, Method 516.6, Procedure V (75 g)
Water & dust proof	IP67
Power Requirement	
Input Voltage	+5 – 12 V DC
Power Consumption	3.2W without external Radio 9.8W with external 2W radio RS400L2

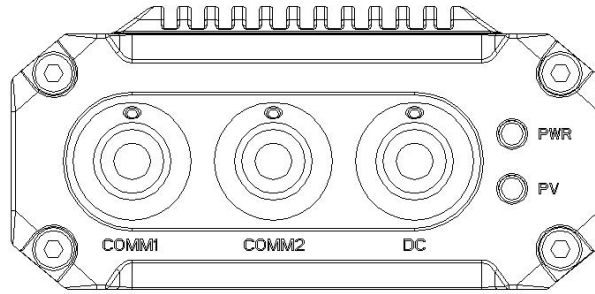

Figure 5.1 Panel of David

Table 13 Pin Definition of connectors on David

Connector Pin No.	COMM1 LVTTTL	COMM2 RS-232	DC
1	PWR	PWR	PWR
2	GND	GND	GND
3	TXD1	TXD2	
4	RXD1	RXD2	
5	GND	GND	
6	CAN_H/PPS ¹	USB D+	
7	CAN_L/EVENT ¹	USB D-	

Note 1: The default configurations for pin 6 and pin 7 of COMM1 port are CAN_H and CAN_L. The two signals are multiplexed with PPS and EVENT. This feature is related to firmware release, contact support@tersus-gnss.com for confirmation.

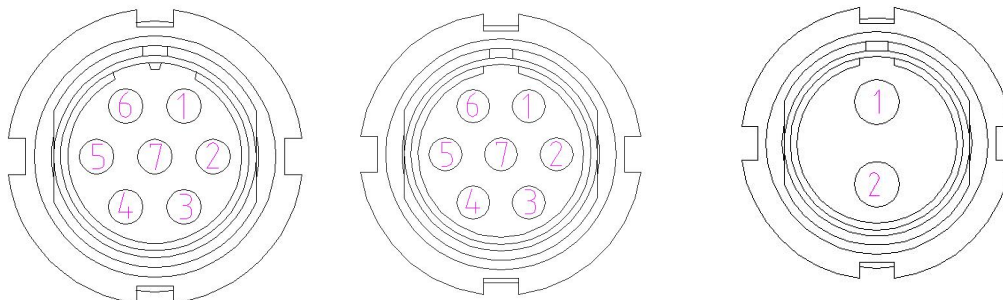
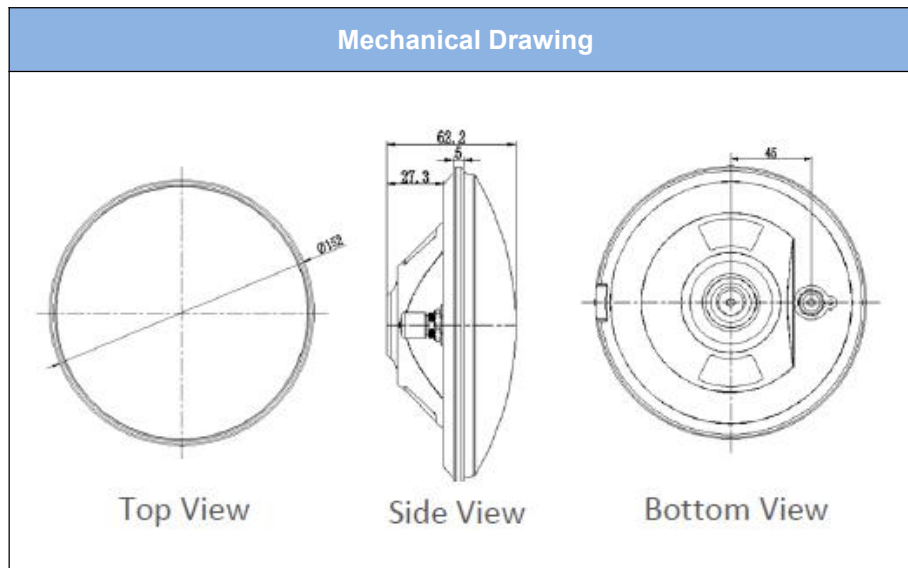

Figure 5.2 Pin Definition of the COMM1/COMM2/DC ports

5.2 Antenna AX3702

Table 14 Antenna AX3702

Antenna Specification	
Tracking signals	GPS L1/L2/L5; BDS B1/B2/B3; GLONASS L1/L2
Impedance	50 Ohm
Polarization	RHCP
Axial Ratio	≤ 3dB
Azimuth Coverage	360°
Output VSWR	≤ 2.0
Peak Gain	5.5dBi
Phase Center Error	± 2mm
LNA Specification	
LNA Gain	40±2dB
Noise Figure	≤ 2.0dB
VSWR	≤ 2.0
Input Voltage	3.3~12V DC
Operating Current	≤ 45mA
Ripple	± 2dB
Physical Description	
Dimension	Φ152*62.2mm
Weight	374g
Signal Connector	TNC Female
Installation connector	5/8" x 11 UNC Female
Environment	
Operating temperature	-45°C - +85°C
Storage temperature	-45°C - +85°C
Damp	45% - 95%



5.3 2W Radio RS400L2

Table 15 Specifications of 2W Radio RS400L2

Communication Interface	
Interface	9.6kbps in the air
	RS-232, baud rate 38400
Voltage and Power	
Input voltage	DC 5 – 12V
Power consumption in transmitting	6.5W (DC 12V, transmitting power 2W) 4W (DC 12V, transmitting power 1W)
Power consumption in receiving	<400mW (DC 5V)
External Antenna	
Impedance	50 ohm
VSMR	≤ 1.5
Interface	TNC female
Modulation & Demodulation	
Modulation	GMSK

Data rate in air	9600bps @ 25KHz	
RF sensitivity	Better than 13dB @ -119dBm	
Decode sensitivity	-116 dBm BER 10E-5@9600bps	
Protocol	Transparent EOT, TT450S and Tersus	
RF Specification		
Frequency range	10MHz (457MHz – 467MHz)	
Channel width	25KHz	
Frequency stability	±1.5 ppm(25C)	
Channel number	10 configurable channels	
Adjacent channel selectivity	≥ 60dB	
Transmission power	High power (2W)	33.5 ± 0.5dBm @ DC5.5V
	Low power (1W)	30.0 ± 0.5dBm @ DC5.5V
Environment		
Temperature	-30°C - +60°C (operating)	
	-40°C - +85°C (storage)	
Mechanical		
Dimension	107 * 62 * 26.6mm	
Weight	213g	

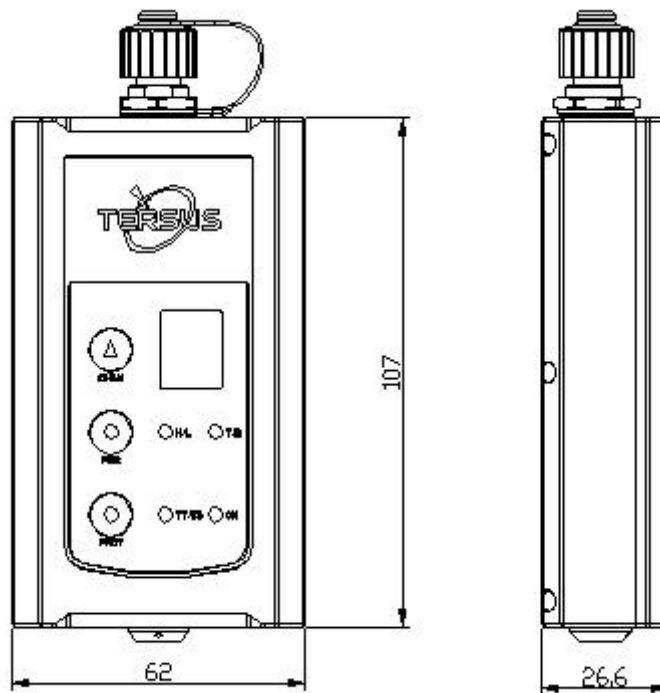

Table 16 Default factory configuration for RS400L2

Channel	Frequency
00	457.550MHz
01	458.050MHz
02	458.550MHz
03	459.050MHz
04	459.550MHz
05	460.550MHz
06	461.550MHz
07	462.550MHz
08	463.550MHz
09	464.550MHz

5.4 30W Radio RS400L30

Table 17 Specifications of 5W Radio RS400L30

Communication Interface		
DTE-DCE Interface	9.6kbps in the air	
	Serial port: RS-232, Band rate 38400	
Interaction		
Power level	High (about 30W)	PWR LED: OFF
	2 nd high (about 20W)	PWR LED: BLUE
	Middle (about 10W)	PWR LED: RED
	Low (about 5W)	PWR LED: RED&BLUE blink
Charging Alarm	DC 11.60 ± 0.2V	
Battery Monitor	B4	DC 13.00 ± 0.2V
	B3	DC 12.50 ± 0.2V
	B2	DC 12.00 ± 0.2V
	B1	DC 11.60 ± 0.2V
Power In/Out		
Input voltage	DC 10.5 – 15.0V	
Power in transmitting (typical)	85W (DC 12.8V, 30W output) 65W (DC 12.8V, 20W output) 46W (DC 12.8V, 10W output) 33W (DC 12.8V, 5W output)	
Transmitting prohibition voltage	DC 11.40 ± 0.2V (default) DC 10.50 – 11.5V (configure range)	
Power in receiving (typical)	<3W (Input voltage DC 12.8V)	
Antenna		
Input Impedance	50 Ohm	
VSWR	≤ 1.5	
Interface	TNC female	
Modulation/Demodulation		
Modulation	GMSK	
Data rate in air	9600bps @ 25KHz	
RF sensitivity	Better than 13dB @ -119dBm	
Decode sensitivity	-116 dBm BER 10E-5@9600bps	
Protocol	Transparent EOT, SOUTH	
Radio		
Frequency range	457 – 467MHz	
Channel width	25KHz	
Stability	±1.5ppm (25C)	

Channel number	116 (channel 00 – 15 are configurable, channel 16 – 116 are fixed)	
Adjacent channel selectivity	≥60dB	
Environment		
Temperature	Operating	-30 – +60°C
	Storage	-40 – 85°C
Dust proof and waterproof	IP68	
Physical Description		
Dimension	165 * 74 * 185.5 mm with plastic protector	
Weight	About 1.75kg	
Data port	LEMO EGA.0B.305	
Power input port	LEMO EGG.1B.302	
Installation	Hook	
Mechanical Drawing		
Signal Definition		
Data Port		Pin 1: GND Pin 2: GND Pin 3: Output power (3A, same voltage as the input) Pin 4: RXD Pin 5: TXD

Power input port		Pin 1: GND Pin 2: PWR input
------------------	---	--------------------------------

Table 18 Default factory configuration for RS400L30

Channel	Frequency
00	457.550MHz
01	458.050MHz
02	458.550MHz
03	459.050MHz
04	459.550MHz
05	460.550MHz
06	461.550MHz
07	462.550MHz
08	463.550MHz
09	464.550MHz
10	463.000MHz
11	463.100MHz
12	463.200MHz
13	463.300MHz
14	463.400MHz
15	463.500MHz

6. Typical operation



- It is highly recommended to double check the module/cable before they are installed to the correct ports.
- Mis-installation with force can damage the David receiver.



The following may be used for David system:

- A power bank for David
- An Android phone
- An external large capacity power if a base kit with 30W or with 2W radio station is used.
- A tripod (optional).
- A tribrach (optional)



It is highly recommended that a David base variant is installed on a tripod.

6.1 David as a Rover to receive corrections from Internet

!	From section 6.1 to section 6.4, David and Android phone are connected via cables; refer to section 3.3.2 for the connection via Bluetooth.
---	---

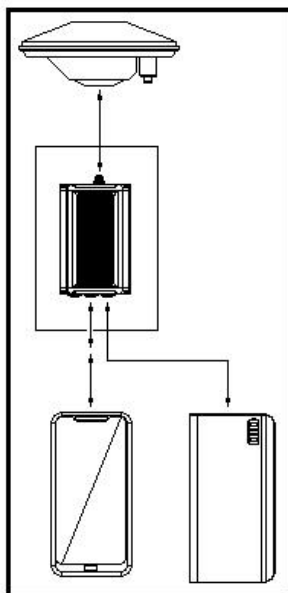

Figure 6.1 Outline of Android phone to David with Wire – Rover

!	<p>Two cables are used to connect the COMM2 port of David to the USB port of the Android phone which are:</p> <ul style="list-style-type: none"> ● COMM2-7pin to USB & DB9 cable or COMM2-7pin to USB & 2W-Radio-5pin cable or COMM2-7pin to USB & 30W-Radio-5pin cable. ● USB Type A Female to USB (Micro + Type C) OTG cable
---	--

The detailed steps of David as a Rover receiving corrections from Internet are as follows:

1. Install the GNSS antenna on a ranging pole at a point interested.
2. Connect the antenna to David with the GNSS antenna cable.
3. Connect the COMM2 port of David to the USB port of an android phone

with cables.

4. Power on David with a power bank.
5. Run Nuwa app, click [Device] -> [Connect].
6. Select [USB] in the option list of Connect Type as shown in Figure 6.2.
7. Click [Connect Config] to update configuration accordingly.
8. Click [Connect] to enable the communication with David.
9. Back to [Device] -> [Rover]
10. Select [Default: PDA Network+Default Server1] as shown in Figure 6.3, click [Detail] to configure the parameters of the Network.
11. Select [Network] for Data Link.
12. Input IP, Port, Username, Password and Mount Point if Ntrip is selected for Protocol Type.
13. Input IP and Port if TCP is selected for Protocol Type.
14. Back to Rover interface, click [Start]
15. When all the configurations above are correct, the rover is receiving RTK corrections as shown in Figure 6.5.

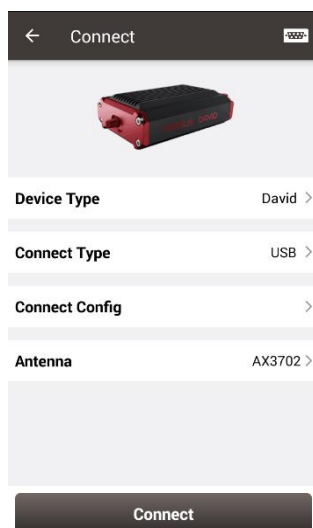

Figure 6.2 Connect David via USB

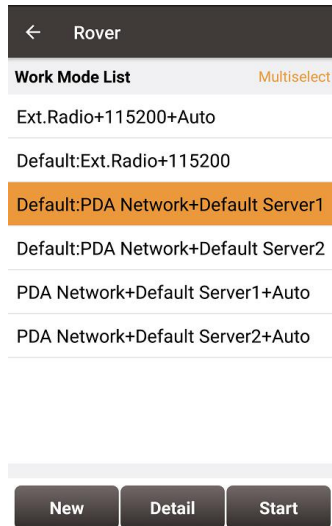

Figure 6.3 Rover setting interface

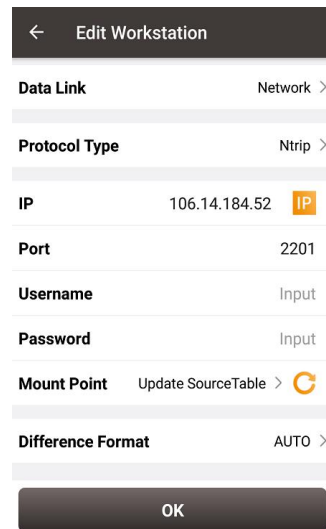

Figure 6.4 Edit Rover configuration

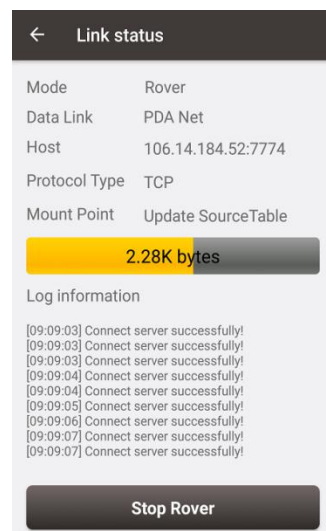

Figure 6.5 Rover is receiving RTK corrections

6.2 David as a Base to transmit corrections to Internet

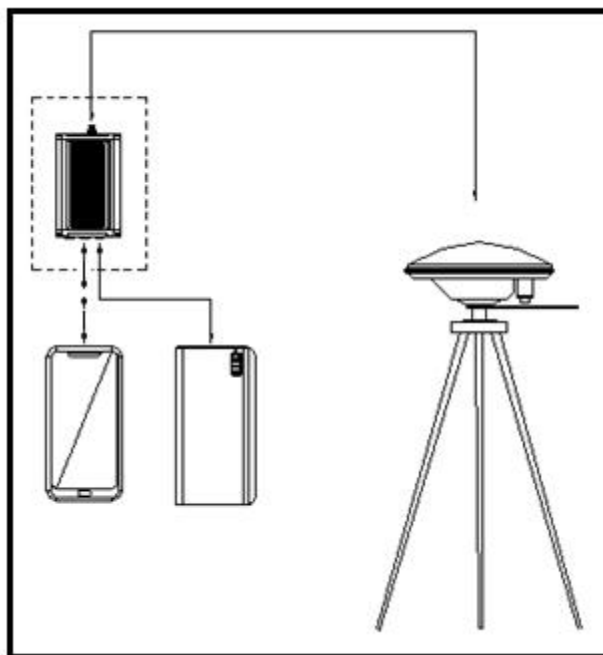

Figure 6.6 Outline of Android phone to David with Wire – Base

!	<p>Two cables are used to connect the COMM2 port of David to the USB port of the Android phone which are:</p> <ul style="list-style-type: none"> ● COMM2-7pin to USB & DB9 cable or COMM2-7pin to USB & 2W-Radio-5pin cable or COMM2-7pin to USB & 30W-Radio-5pin cable. ● USB Type A Female to USB (Micro + Type C) OTG cable
---	--

!	<p>It's highly recommended that a base David is installed on a tripod.</p>
---	--

The detailed steps of David as a base transmitting corrections to Internet are as follows:

1. Install the tripod at a point interested.
2. Install a Tribach on the tripod, adjust it to horizontal level and install the GNSS antenna and the antenna connector on it.

3. Connect the antenna to David with the GNSS antenna cable.
4. Connect the COMM2 port of David to the USB port of an android phone with cables.
5. Power on David with a power bank.
6. Run Nuwa app, click [Device] → [Connect].
7. Select [USB] in the option list of Connect Type as shown in Figure
8. Click [Connect Config] to update configuration accordingly.
9. Click [Connect] to enable the communication with David.
10. Back to [Device] → [Base]
11. Select [Default: Auto Startup+PDA Network+Default Server1+RTCM32], then click [Detail] to configure the parameters about the Network.
12. If [Auto Start] is selected for start method, skip to step 14.
13. If [Manual Start] is selected for start method, input the position of the base manually.
14. If Ntrip protocol is selected, input information include: IP, Port, Username, Password and Mount Point.
15. Back to [Device] → [Base], click [Start].
16. When all the configurations above are correct, the base is transmitting RTK corrections as shown in Figure 6.10.

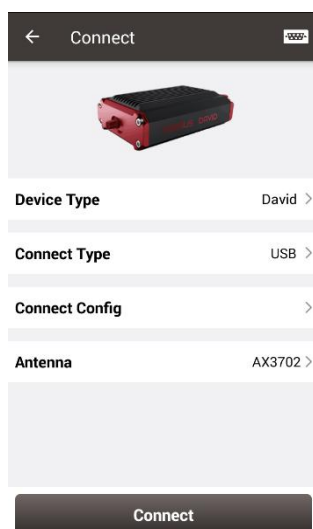

Figure 6.7 Connect David via USB

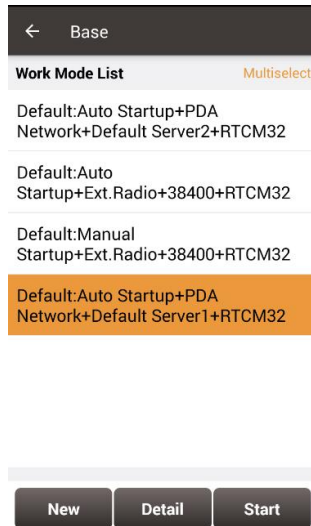

Figure 6.8 Base setting interface

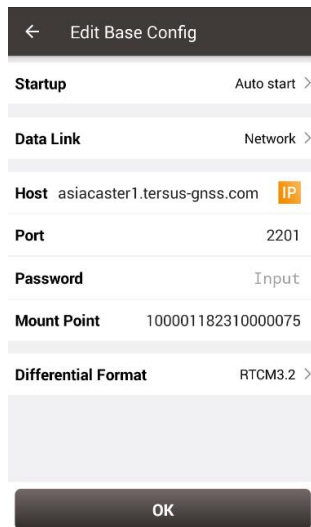

Figure 6.9 Edit Base configuration



Figure 6.10 Base is transmitting corrections

6.3 Radios Transmit RTK Corrections between Two David receivers

!	<ul style="list-style-type: none"> ● 2W base should work with 2W rover. ● 30W base should work with 2W rover.
---	---

This section introduce the configuration of 30W base and 2W rover for reference.

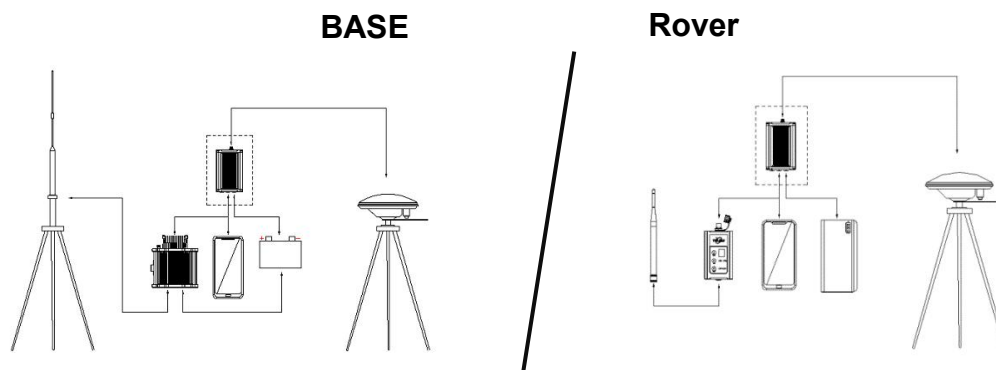

Figure 6.11 Outline of Base/Rover with Radios

The detailed steps of David with 30W radio as a base transmitting corrections to a David with 2W radio as a rover are as follows:

Hardware connection for David as a base with 30W radio

1. Install the two tripods at the points interested.
2. Install the High Gain Radio Antenna with the telescopic pole for radio antenna if needed.
3. Refer to Figure 2.39, install the metal plate, the GNSS antenna connector and the High Gain Radio Antenna on one tripod.
4. Install a Tribach on the other tripod, adjust it to horizontal level and install the AX3702 GNSS antenna and the antenna connector on the tripod.

5. Connect the antenna to the base David with the GNSS antenna cable.
6. Connect the COMM2 port of the David receiver to the USB port of an Android phone using COMM2-7pin to USB & 30W-Radio-5pin cable.
7. Install the GNSS antenna cable from the telescopic pole to the 30W radio station.
8. Connect the 5pin connector of COMM2-7pin to USB & 30W-Radio-5pin cable to 30W radio, and insert the DC-2pin port of 30W radio using two cables (DC-2pin & 30W-Radio-DC-2pin to Bullet-DC and Bullet-DC to Alligator Clips).
9. Double check the connections above and connect the alligator clips to the external battery.

Hardware connection for David as a rover with 2W radio

10. Install the AX3702 GNSS antenna on a ranging pole and place it at the point interested.
11. Connect the 2W/460MHz radio antenna to the rover David with the GNSS antenna cable.
12. Install the COMM2-7pin to USB & 2W-Radio-5pin cable to the COMM2 port of the rover David, and connect the other two connectors to the USB port of the Android phone with cables and to the 2W radio station, respectively.
13. Power on David with an external power bank.

Software configuration for David as a base with 30W radio

14. Refer to section 3.3.1 for the communication between an Android phone and the David as a base.
15. Run Nuwa app, click [Device] -> [Base].
16. Select [Auto Startup+Ext.Radio+38400+RTCM32], click [Detail].
17. If [Auto Start] is selected for start method, skip to step 20.

18. If [Manual Start] is selected for start method, input the position of the base manually
19. Click [OK] to return to the Base interface, click [Start] to complete the configuration.

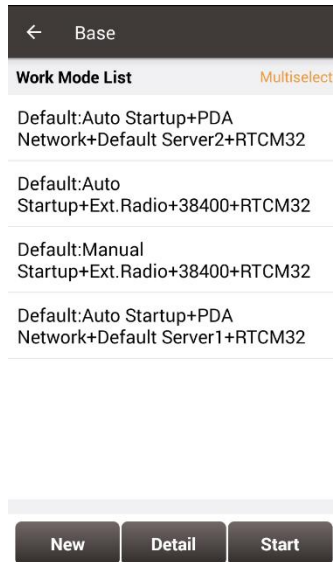

Figure 6.12 Base work mode list

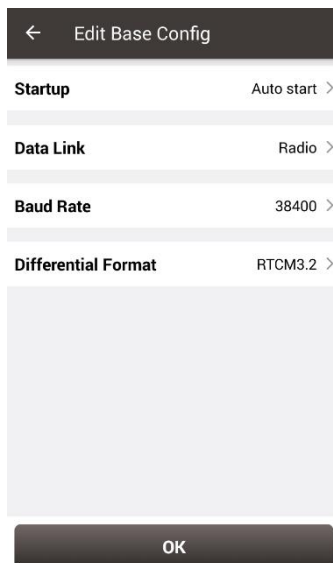

Figure 6.13 Edit base configuration

Software configuration for David as a rover with 2W radio

20. Refer to section 3.3.1 for the communication between an Android phone and the David as a rover.

21. Run Nuwa app, click [Device] -> [Rover].
22. Select [Ext.Radio+38400], click [Detail].
23. Ensure the Data Link is Radio and Baud Rate is correct.
24. Click [OK] to return to the Rover interface, click [Start] to complete the configuration



Figure 6.14 Rover work mode list

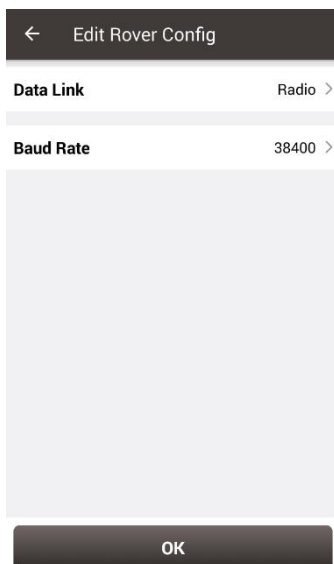



Figure 6.15 Edit rover configuration

6.4 Data Collection for Post Processing

!	<p>The size of the logging:</p> <p>Collect raw measurements at 1Hz (about 110Kbyte/min if 20 satellites are tracked, about 165Kbyte/min if 30 satellites are tracked)</p> <p>If the collection frequency increases, the data size would increase proportionately.</p>
---	---

	<p>David provides up to 4GB internal EMMC card for data collection, before data collection, estimate whether the free space is enough for the data collection. Refer to section 3.6 to delete the files on EMMC card to get more free space.</p>
---	--

	<p>During data collection, the antenna should be installed on a tripod.</p>
---	---

!	<p>Rules for the file name & update time in the internal EMMC card:</p> <ol style="list-style-type: none"> 1) Name: file name is the 00..00xx..xx.dat, totally 8 digits, in which xxxx is the working time (seconds/100) of the David. For example, the David has worked 500 hours 40min, $(500*3600 + 40*60)/100 = 18024$, the file name is 00018024.dat. 2) Update time: if the David has not obtained the GNSS time, the update time of the files is 19800000 0:0 (YYYYMMDD HH:MM). If the David has obtained the GNSS time, the update time is the UTC time.
---	---

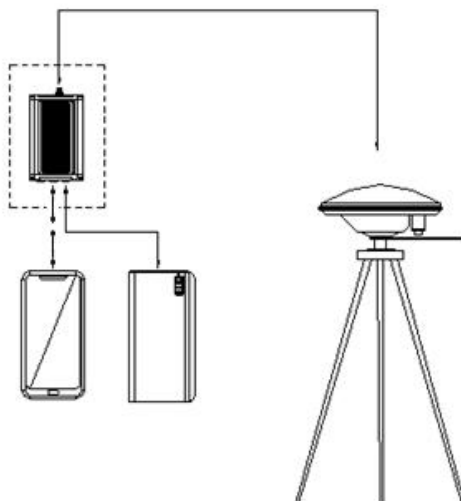

Figure 6.16 Outline of Static Data Collection

The detailed steps for static data collection are as follows:

Hardware connection

1. Install a tripod at a point interested.
2. Install a tribrach on the tripod, adjust it to horizontal level and install the GNSS antenna and the antenna connector on the tribrach.
3. Connect the AX3702 GNSS antenna to the David with the GNSS antenna cable.
4. Create communication between the David and the Android phone with cables, refer to section 3.3.1.

Software configuration

5. Run Tersus Survey app Nuwa, click [Survey] -> [Static Survey].
6. Ensure the necessary parameters including interval, cutoff angle, etc. are filled, then click [Start].
7. Repeat steps 1 – 6 above to collect static data at other points interested.

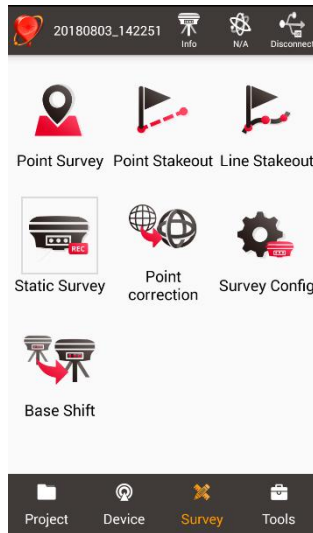

Figure 6.17 Survey interface on Nuwa app

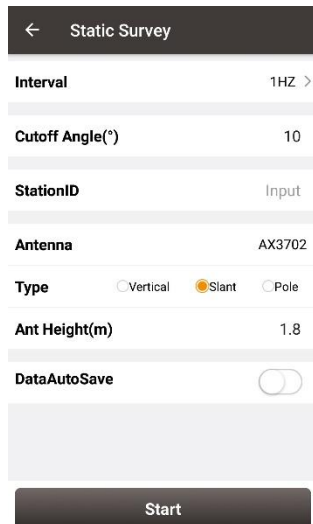

Figure 6.18 Static survey configuration

6.5 Auto Base Station List Function

If a base is setup with command POSAVE, according to its original definition, after a power cycle, the fixed position may be different even if the receiver is installed at the same point. More details about command POSAVE refer to the Log & Command document. For the users who need the base to keep the same fixed position after a power cycle, auto base station list function is introduced.

The procedure is introduced as below:

1. Follow Figure 3.6 and the detailed steps in section 3.4.1 to create communication between a David receiver and Tersus GNSS Center.
2. Under the menu, click [Tool] -> [Auto Base Station List] to get below interface.

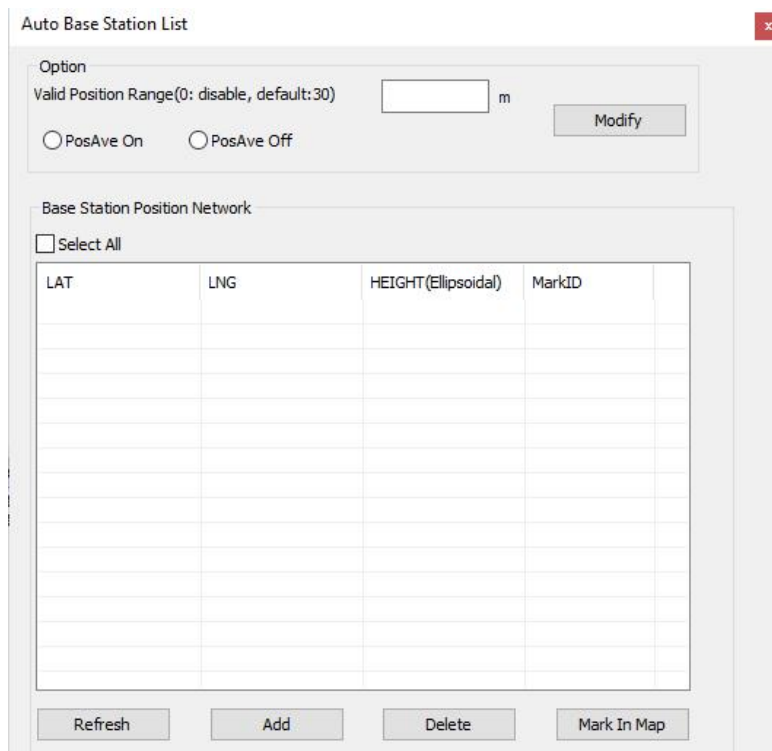

Figure 6.19 Auto Base Station List interface

3. Input the valid position range, check PosAve On, and click [Modify]. It is

recommended that valid position range is >20m.

4. After the specific time (in the example, 0.01 hour is 36 seconds), the base is fixed within 36 seconds averaging position.
5. Click [Refresh], the fixed position is displayed as below.

Auto Base Station List ✕

Option

Valid Position Range(0: disable, default:30) m

PosAve On
 PosAve Off

Base Station Position Network

Select All

LAT	LNG	HEIGHT(Ellipsoidal)	MarkID	
<input checked="" type="checkbox"/> 31.19042830	121.59319162	37.41683394	0	

Figure 6.20 Fixed position for base station

6. After a power cycle, if the base is moved less than 20m away from the last position, it would fix with the same position. In the above example, latitude keeps 31.19042830, longitude keeps 121.59319162 and ellipsoid height keeps 37.4168.

6.6 2W Radio operation

6.6.1 Radio Function Description

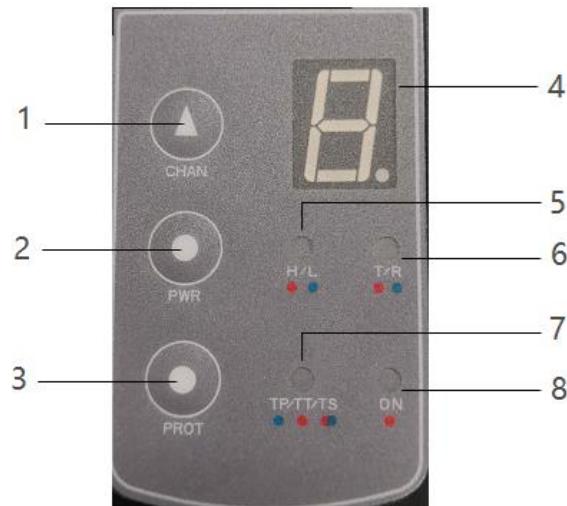

Figure 6.21 Front Panel of the 2W Radio

No.	Definition
1	Channel switching button
2	Power switching button
3	Protocol switching button
4	Current channel display
5	Power indicator (H/L)
6	Transceiver mode indicator
7	Protocol indicator
8	Power Supply indicator

1) Boot up

The radio module is boot up directly when powered on.

2) Channel switching

Press the channel switching button once, the channel is increased by one; the

LED displays the current channel value; the channel display is 0 to 9, and the default is 0.

3) Power switching

Press the power switching button once, the power is switched once; the power indicator is steady red to indicate high power 2W, and indicator is steady green to indicate low power 1W, and the default is high power.

4) Protocol switching

Press the protocol switching button once, the protocol is switched once; TP represents Transparent, TT represents TT450S, TS represents the custom protocol TERSUS; the default is TP.

5) Transceiver mode switching

Simultaneously press and hold the channel switching button and power switching button for 1 second to switch the transceiver mode; T is steady red for transmit mode, and red light is flashing for transmitting data; R is steady green for receive mode, and green light is flashing for receiving data; the default is the receive mode.

6) Restore default configuration

Simultaneously press and hold the power switching button and protocol switching button for 1 second to recover to the default configuration.

6.6.2 Radio Installation

As a transmission, the radio is hooked on a tripod; as a rover station, the radio is installed in the rover station bracket.

- 1) Large amount of heat would be generated when the radio is in transmission. When the radio is working, please do not place the radio in poor ventilated box, wrap or cover any item on the surface of the radio.
- 2) In an environment with a high temperature of more than 40 °C or intense sunlight, the surface of the radio would be hot when it is transmitting at high power. It may cause scald if the surface of the machine is touched directly. Please pay special attention.

6.6.3 Antenna Installation

Whether the antenna is properly installed and erected would seriously affect the transmission distance of the radio, hence the correct connection and installation of the antenna is of high importance.

- 1) It is strictly forbidden to use a damaged antenna. The output impedance of the antenna interface of this radio is 50 ohms. Please use antennas and feeders with input impedance of 50 ± 2 ohms and VSWR less than 1.5. Using an antenna that is not strictly matched with this radio would result in a shortened transmission distance for the radio, and it is possible to damage the radio if the mismatch is particularly serious.
- 2) The original antenna of this radio is strictly matched with this radio, and the performance meets the requirements of this radio. The original antenna of this radio would better play the performance of this radio.
- 3) Under normal circumstances, the height of the antenna installed from the ground would significantly increase the transmission distance and improve the transmission effect.
- 4) Carefully check the connection of the antenna, feeder, connector and the components of the radio to ensure well contact and reliable connection between the antenna and the connector of the radio.

6.7 30W Radio operation

6.7.1 Radio Function Description



Figure 6.22 Front Panel of the 30W Radio

No.	Definition
1	Field intensity / power voltage indicator
2	Digitron display
3	Transmit / Receive indicator
4	Power / warning indicator
5	Power ON/OFF button
6	Channel switching button – increasing
7	Channel switching button – decreasing
8	Battery Capacity checking button
9	RF power switching button
10	Power indicator

1) Power on

Press ON/OFF button to power on 30W radio when it is connected with external power input.

2) Channel switching

In the power on state, press ∇ to adjust the radio channel downwards, and press \triangle to adjust the radio channel upwards.

3) Power switching

In the power on state, press RF PWR button to switch RF transmitting power of the radio. Press this button once, the power is switched once. The power indicator is off light means that it is transmitting the maximum power.

4) Battery capacity check

In the power on state, press BAT CAP button to check the battery capacity of the external power supply.

5) Configuration mode

In the power off state, simultaneously press the \triangle button and ON/OFF button for 3 seconds to enter the configuration mode.

6) Protocol switching

In the radio configuration mode, simultaneously press BAT CAP button and ∇ button to switch protocols. The digitron displaying P2 indicates Transparent protocol, P3 indicates TT450S protocol, and P6 indicates the custom protocol TERSUS. The default protocol is P2 which is Transparent protocol.

After configuration, press ON/OFF to power off the radio and it will start with new configuration.

6.7.2 Radio Installation

The 30W radio is hooked on a tripod for the base station.

- 1) Large amount of heat would be generated when the radio is in transmission. When the radio is working, please do not place the radio in poor ventilated box, wrap or cover any item on the surface of the radio.
- 2) In an environment with a high temperature of more than 40 °C or intense sunlight, the surface of the radio would be hot when it is transmitting at high power. It may cause scald if the surface of the machine is touched directly. Please pay special attention.

6.7.3 Antenna Installation

Whether the antenna is properly installed and erected would seriously affect the transmission distance of the radio, hence the correct connection and installation of the antenna is of high importance.

- 1) It is strictly forbidden to use a damaged antenna. The high gain radio antenna is in the designated antenna for 30W radio. Using an antenna that is not strictly matched with this radio would result in a shortened transmission distance for the radio, and it is possible to damage the radio if the mismatch is particularly serious.
- 2) The original antenna of this radio is strictly matched with this radio, and the performance meets the requirements of this radio. The original antenna of this radio would better play the performance of this radio.
- 3) Under normal circumstances, the height of the antenna installed from the ground would significantly increase the transmission distance and improve the transmission effect.
- 4) Carefully check the connection of the antenna, feeder, connector and the components of the radio to ensure well contact and reliable connection between the antenna and the connector of the radio.

7. Terminology

Table 19 List of Terminology

Abbreviation	Definition
ASCII	American Standard Code for Information Interchange
CMR	Compact Measurement Record
CORS	Continuously Operating Reference Stations
DC	Direct Current
ESD	Electro Static Discharge
ECEF	Earth Center Earth Fixed
GLONASS	GLObal Navigation Satellite System
GNSS	Global Navigation Satellite System
GPS	Global Positioning System
IF	Intermediate Frequency
IMU	Inertial Measurement Unit
IO	Input / Output
LED	Light Emitting Diode
LNA	Low Noise Amplifier
MPU	Micro Processing Unit
NMEA	National Marine Electronics Association
PC	Personal Computer
PPK	Post Processing Kinematic
PPS	Pulse Per Second
RF	Radio Frequency
RINEX	Receiver Independent Exchange format
RMS	Root Mean Squares
RTK	Real-Time Kinematic
RTCM	Radio Technical Commission for Maritime Services
SMA	Sub-Miniature-A interface

SSID	Service Set Identifier
TTF	Time to First Fix
TTL	Transistor-Transistor Logic level
UART	Universal Asynchronous Receiver/Transmitter
USB	Universal Serial BUS
WGS84	World Geodetic System 1984

Proprietary Notice

All Information in this document is subject to change without notice and does not reflect the commitment on Tersus GNSS Inc. No part of this manual may be reproduced or transmitted by all means without authorization of Tersus GNSS Inc. The software described in this document must be used in terms of the agreement. Any modification without permission from Tersus GNSS Inc. is not allowed.